

PROFESSIONAL SERIES

IN-CEILING LOW PROFILE SPEAKER PS-C63RTL



Introducing the Sonance Professional Series

From Sonance, the company that created the architectural audio category comes a range of professional loudspeakers that set a new benchmark in sound quality and aesthetics for commercial environments.

Sonance Professional Series includes a range of In-Ceiling, Pendant and Surface Mount Speakers that deliver unequalled fidelity, extremely low distortion, wide dispersion and a smooth power response. The range also shares consistent voicing, ensuring seamless sonic integration when used together throughout a space.

The Sonance Professional Series PS-C63RTL In-Ceiling Speaker utilizes a shallow 4.37" (111mm) construction for installations in restricted spaces such as beneath HVAC ducting. It also features a one-piece bezel-less grille that is magnetically secured and allows for a one-step painting process to simplify installation and minimize visual distraction.

The optional Square Grille Adapter allows speakers to match the aesthetic of square downlights and HVAC grilles to achieve continual sight lines.

A high-excursion 6.5" polypropylene woofer delivers effortless low bass extension, even at high volumes, while the pivoting chambered 1" soft dome tweeter can be directed to ensure accurate coverage, when speaker positioning is compromised.

The PS-C63RTL features a sealed metal enclosure with back and side knock-outs, removable Euroblock connector with loop-through, and seismic attachment. Additionally, the Sonance PS-C63RTL is certified for UL 1480 and UL 2043.



Features & Benefits

Performance

- Class-leading sensitivity & sonic performance
- Exceptional off-axis response
- Heavy duty voice coil for longevity and reliability
- Full-fidelity transformer for uncompromised tonality
- Consistent voicing across product range

Aesthetics

- Bezel-less design for clean and minimalistic aesthetic
- Optional Square Adapters to match light fixtures
- Optional black grilles in round or square

Installation

- Magnetic grille retention for fast installation and removal
- Finger-adjustable selector tap
- One-step simplified painting process
- Shallow design for limited depth installations

Applications

- Boardrooms & Corporate Offices
- Shopping Malls, Retail Spaces & Showrooms
- Restaurants, Bars & Lounges
- Galleries & Museums
- Casinos, Convention Centers & Hotels
- Houses of Worship
- Educational Facilities

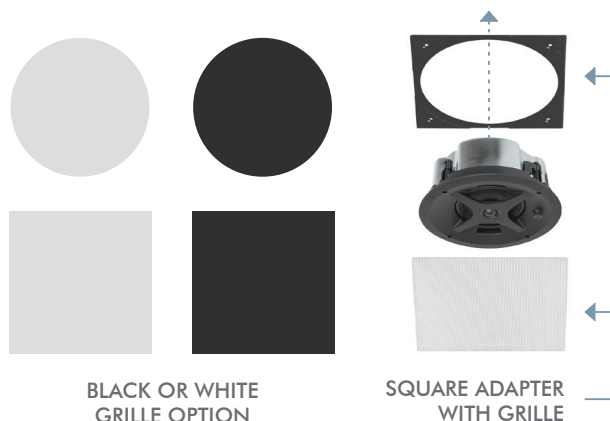

Specifications



PS-C63RTL SKU# 40182

LOUDSPEAKER

Frequency Range (-10dB):	49Hz – 25kHz
Frequency Range (-3dB):	65Hz – 20kHz
Power Capacity:	120 Watts Continuous Program Power 60 Watts Continuous Pink Noise
Nominal Sensitivity:	91dB
Nominal Coverage Angle:	120 degrees conical coverage
Directivity Factor (Q):	6.5
Directivity (DI):	7.9dB
Rated Maximum SPL:	108dB @ 1 meter (3.3 feet) average, 116dB peak
Rated Impedance:	8 Ohms nominal, 6 Ohms minimum
Transformer Taps:	70V: 60W, 30W, 15W and 7.5W 100V: 60W, 30W and 15W
Crossover Point:	2750Hz
Overall Dimension:	11.06" Diameter x 4.37" Depth (281mm x 111mm)
Cut Out Dimension:	10.125" Diameter (257mm)
Net Weight:	10.00 lbs (4.53kg) each
Shipping Weight:	38.00 lbs (17.23kg) pair
Unit of Measure:	Pair
Grille:	Supplied with bezel-less white grille, black grille optional

TRANSDUCERS

LF Driver:	6.5" (165mm) Polypropylene Cone, Butyl Rubber Surround
HF Driver:	1" (25mm) Cloth Dome, Pivoting, Ferrofluid cooled

ENCLOSURE

Input Connectors:	Four pin Euroblock with loop output connections
Knockouts:	One, side mounted .75"
Safety Agency:	UL 1480, UL 2043, NFPA 90A, NFPA 70
Maximum Ceiling Thickness:	1.732" (44mm)
Suspension Points:	One, on top surface

Included Accessories

- C-Ring x 2
- Tile Support Rails x 4
- Cutout Template x 2
- Euroblock Connector x 2
- White Grille x 2

Optional Accessories

- Replacement Round Grille White (1 pair) | 40154
- Round Grille Black (1 pair) | 40157
- Square Adaptor w/ Grille White (5 pair) | 40160
- Square Adaptor w/ Grille White (1 pair) | 45160
- Square Adaptor w/ Grille Black (5 pair) | 40163
- Square Adaptor w/ Grille Black (1 pair) | 45163
- Flex Bracket (5 pair) | 92247
- Metal Pre-construction Bracket (6 pack) | 40125
- Tile Support Rails w/ C-Ring (1 pair) | 40174
- Replacement RotoLock Feet (Bag) | 40175

Performance Measurements

1 METER ON AXIS FREQUENCY RESPONSE

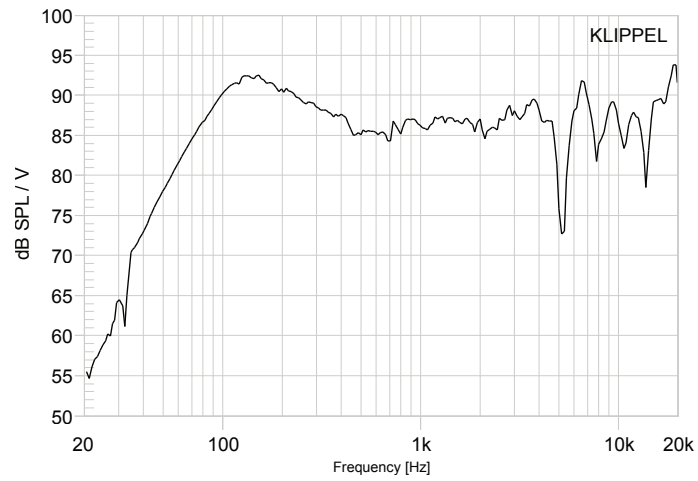

IMPEDANCE vs FREQUENCY

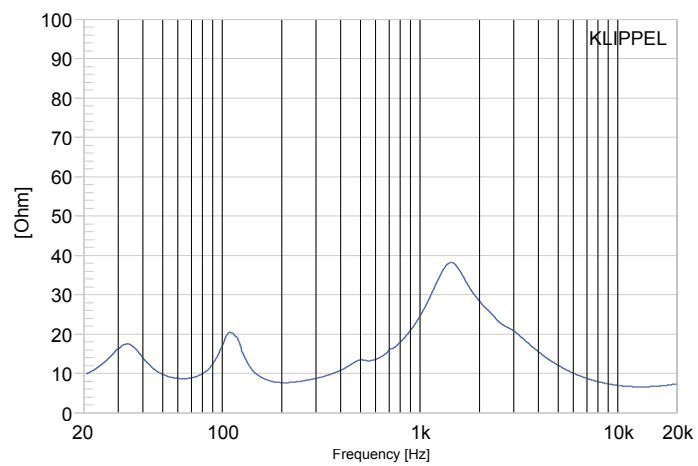

1 METER HORIZONTAL FREQUENCY RESPONSE

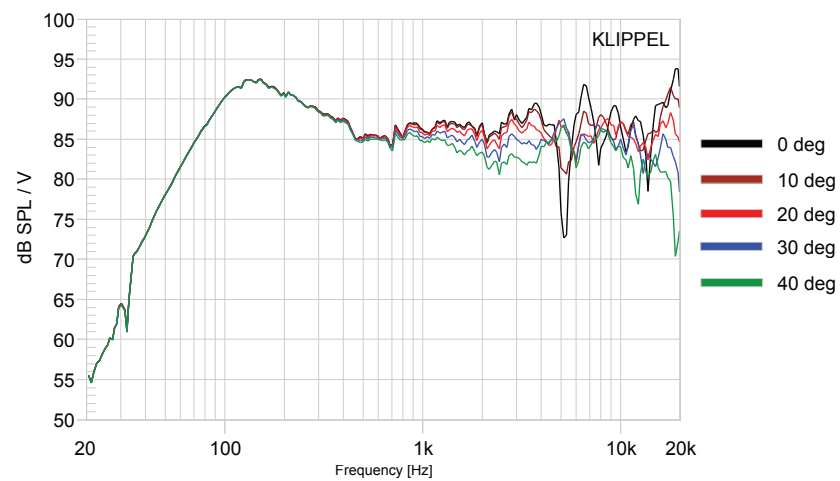

Performance Measurements

BEAMWIDTH vs FREQUENCY

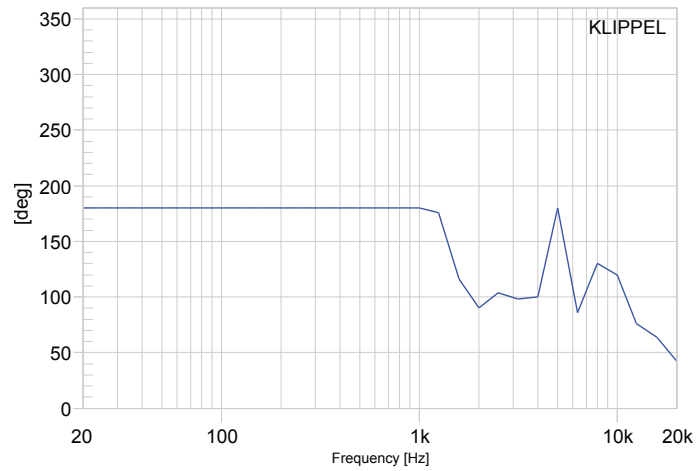

DIRECTIVITY INDEX vs FREQUENCY

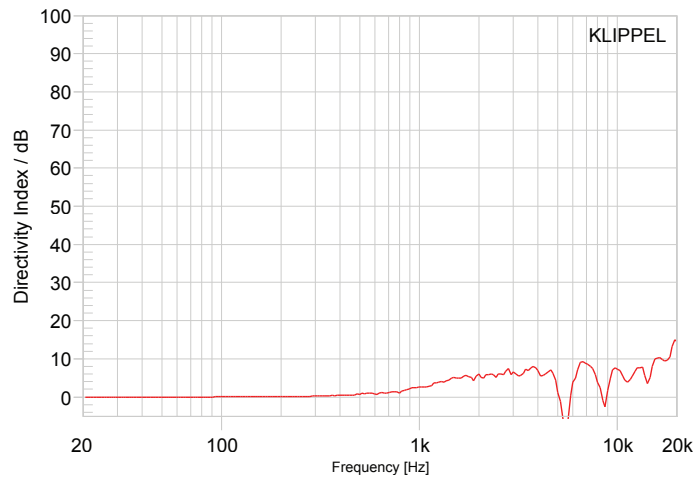

Polar Plots (1/3 Octave)

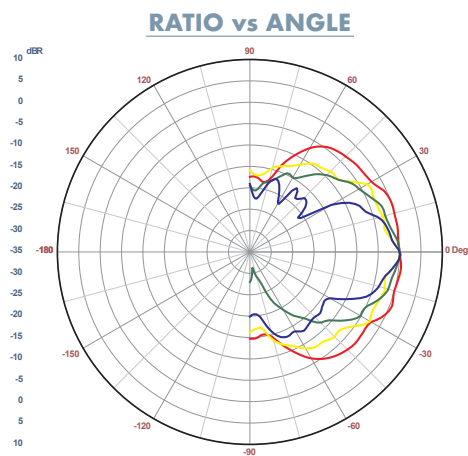
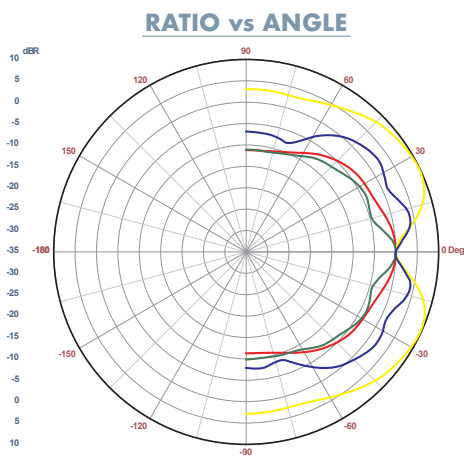
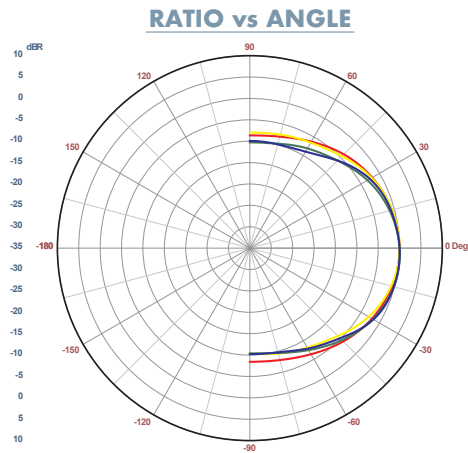
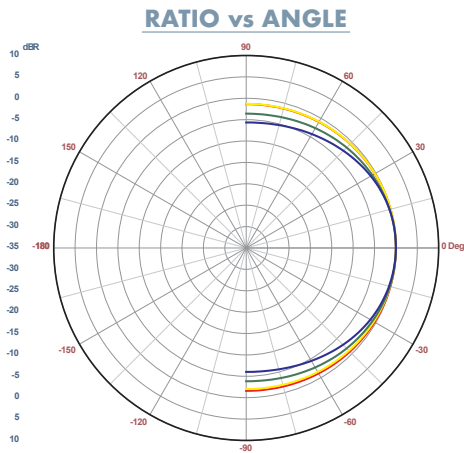
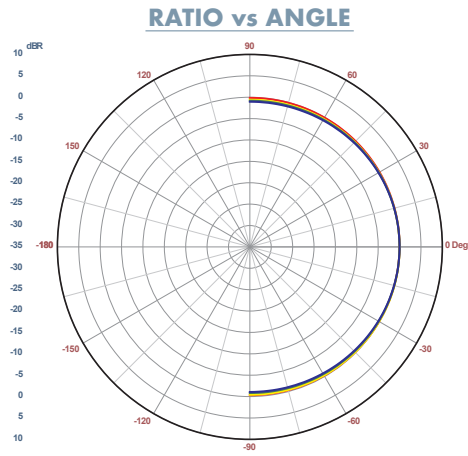
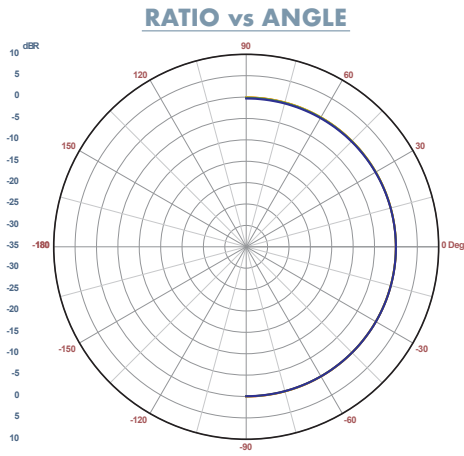

Dimensional Sketches Specifications

PS-C63RTL P Loudspeaker

Diameter: 11.06" (281mm)
 Depth: 4.37" (111mm)
 Cut Out Diameter: 10.125" (257mm)

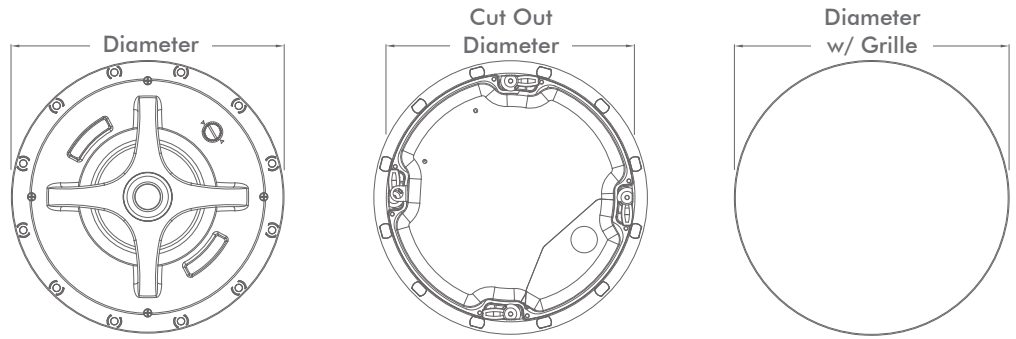

With Grille

Diameter: 11.06" (281mm)

With Square Adapter and Grille

Width: 11.14" (283mm)
 Height: 11.14" (283mm)

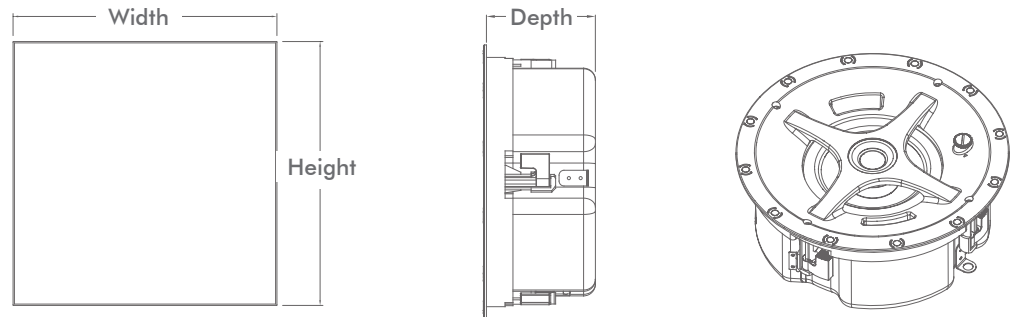

Tile Bridge

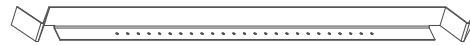

C-Ring

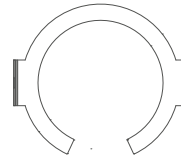

Flex Bracket

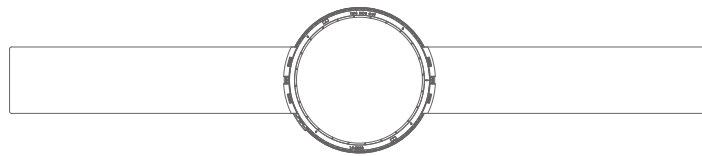

Metal Pre-construction Bracket

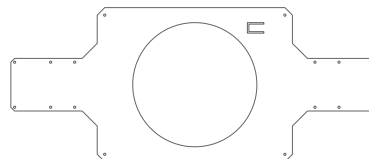

Architectural Specifications

The loudspeaker shall be of the two way type comprising a single flush mount enclosure containing one 6.5" (165mm) Polypropylene Cone, Butyl Rubber Surround low frequency transducer and one coaxially mounted pivoting 1" (25mm) Cloth dome, Pivoting, Ferrofluid cooled high frequency transducer. It shall utilize a one-piece bezel-less grille design and an optional square grille adapter shall also be available if required. Frequency range shall be 65Hz – 20KHz (-3dB). Total power handling shall be 60 Watts continuous pink noise and 120 Watts program. Sensitivity measured with 2.83 volts input at 1 meter on axis averaged between 65Hz – 20KHz shall be 91dB. The unit shall be supplied with a line matching transformer suitable for 100 volt or 70 volt with a front mounted control allowing user selectable power taps of 60W, 30W, 15W, 7.5W and a 8 Ohm bypass. The back shall be constructed from deep drawn steel.

The baffle shall be ported and injection molded using fire rated ABS that meets UL 94V-0. The speaker shall be suitable for use in air handling spaces per UL 1480, UL 2043, NFPA 90 and NFPA 70 S7232 UL Listed signaling speaker. Wire shall be terminated on the rear of the back can with access via the rear or side knock-out. A seismic attachment shall be provided on the rear of the back can to allow additional support when necessary. The system shall include a support backing plate to reinforce the ceiling material and tile support rails which can all be installed from beneath the ceiling tile. External dimensions shall be 11.06" Diameter x 4.37" Depth (281mm x 111mm). The total enclosure shall weigh 5 lbs. (2.27 kg) per unit. The loudspeaker shall be the Sonance Professional Series PS-C63RTL. No other system shall be acceptable unless the above combined performance specifications are equaled or exceeded.

Safety Agency Compliance

Sonance Professional Series In-Ceiling Speaker are compliant with:

UL 2043: Standard For Safety For Speakers for Fire Alarm, Emergency, and Commercial and Professional Use.

UL 1480: Standard For Safety For Speakers for Fire Alarm, Emergency, and Commercial and Professional Use.

NFPA 70: 2002 National Electrical Code

NFPA 90A: Installation of Air Conditioning and Ventilation Systems, Section 2-3.10.1(A)



Warranty, Remedy, Exclusions and Limitations (USA only)

Limited Warranty

Sonance warrants this product to the original purchaser to be free from defects in material and workmanship, under normal use and conditions, for a period of five (5) years from the date of original purchase as shown on the invoice.

The foregoing exclusive warranty gives you specific legal rights, and you may have other rights, which vary from state to state. This warranty applies exclusively to the original purchaser.

The exclusive warranty does not apply and is ineffective if:

1. The invoice fails to establish that the product was purchased from an authorized Sonance dealer or distributor;
2. The product was subjected to misuse, neglect, accident, or improper installation. (Damage to the product was caused by accident, abuse or misuse);
3. The product was modified, altered, or repaired by unauthorized personnel; or
4. The unit was not used as described in the installation and operating instructions.

Exclusive Remedy

Sonance agrees, at its option during the five (5) year warranty period, to repair any defect in material or workmanship or to furnish an equal product in exchange without charge to the purchaser, subject to the verification of the defect and proof of the date of purchase.

Warranty Exclusions and Damage Limitations

The exclusive warranty set forth above is in lieu of all other warranties, express or implied, including without limitation the implied warranties of merchantability and fitness for a particular purpose, which are expressly disclaimed. In no event, and under no circumstances or legal or equitable theory, shall Sonance be liable or responsible for any direct or indirect damages, consequential damages, loss, or injury, including without limitation, personal injury, bodily injury, property damage, emotional distress, death, real property or personal property damage, business interruption, costs of delay or lost profits arising from the product, whether based upon warranty, contract, negligence, strict product liability or other theory.

Associated Products

In-Ceiling Speakers

PS-C43RT In-Ceiling Speaker	40130
PS-C63RT In-Ceiling Speaker	40131
PS-C83RT In-Ceiling Speaker	40132
PS-C83RWT In-Ceiling Speaker	40133
PS-C43RTLTP In-Ceiling Speaker	40181

Pendant Speakers

PS-P43T Pendant Speaker White	40134
PS-P63T Pendant Speaker White	40135
PS-P83T Pendant Speaker White	40136
PS-P83WT Pendant Speaker White	40137
PS-P43T Pendant Speaker Black	40138
PS-P63T Pendant Speaker Black	40139
PS-P83T Pendant Speaker Black	40140
PS-P83WT Pendant Speaker Black	40141

Surface Mount Speakers

PS-S43T Surface Mount Speaker White	40142
PS-S53T Surface Mount Speaker White	40143
PS-S63T Surface Mount Speaker White	40144
PS-S83T Surface Mount Speaker White	40145
PS-S83WT Surface Mount Speaker White	40146
PS-S43T Surface Mount Speaker Black	40147
PS-S53T Surface Mount Speaker Black	40148
PS-S63T Surface Mount Speaker Black	40149
PS-S83T Surface Mount Speaker Black	40150
PS-S83WT Surface Mount Speaker Black	40151

DSP Amplifier

Sonamp DSP 2-750 Amplifier	93095
----------------------------	-------



©2017 Sonance. All rights reserved.
Sonance is a registered trademark of Dana Innovations.

Due to continuous product improvement, all features and specifications are subject to change without notice.
For the latest Sonance product specification information visit our website: www.sonance.com

SONANCE • 991 Calle Amanecer • San Clemente, CA 92673 USA
(949) 492-7777 • FAX: (949) 361-5151 • Technical Support: (949) 492-7777
www.sonance.com/professionalseries

02.22.18