



## Savant® Rack Mountable Hosts Deployment Guide

Document Number: 009-1914-02  
Document Date: November 2021  
Document Supports: da Vinci 9.2 and higher

This document will guide the installer through the process of installing, configuring, and adding a Savant SHR-S2/2000 Host to a RacePoint Blueprint™ configuration.

- S2 Host Rack Mountable [SHR-S2-xx]
- Smart Host Rack Mountable [SHR-2000-xx]

# Contents

To access links to the topics within this document, click the corresponding entry in the table below.



1. Before You Begin .....	4	6. Host Configuration .....	15
2. Deployment Steps .....	5	6.1. Change the Host User Password.....	15
3. Installation.....	6	6.2. Setting Up Mail (Gmail Only) for Notifications .....	15
3.1. Mounting Plate .....	6	6.3. Querying and Configuring DNS and IP Address .....	16
3.2. Rack Mount.....	6	7. Running Scripts.....	18
4. Wiring and Connections.....	7	7.1. Recalling Script Files.....	18
4.1. Power .....	7	7.2. Executing Scripts on the Host.....	19
4.2. Ethernet .....	7	8. Troubleshooting.....	20
Wired Connection .....	7	8.1. Retrieving Logs.....	20
Wireless Connection (SHR-S2 only) .....	7	8.2. Stopping and Starting the Host.....	21
4.3. Audio Output.....	7	8.3. Uploading Configuration to the Host .....	22
4.4. Control Connections .....	8	8.4. Copying the Configuration File to the SDE.....	22
RS-232 Wiring .....	8	Appendix A: Network Requirements .....	23
IR Wiring.....	9	Device Network Connections.....	23
Relay Wiring.....	9	Managing IP Addresses .....	23
GPIO Wiring .....	10	Network Changes .....	23
5. Blueprint Configuration .....	11	Network Guidelines.....	23
5.1. Replacing a Host in a Configuration .....	12	Appendix B: UPS Recommendations.....	24
5.2. Adding a Host to the Layout Window .....	13		
5.3. Adding a Doorbell or Door Station .....	13		
5.4. Use of Custom Automator Workflows and Applescripting .....	14		

## Important Safety Information - Read First



Before installing, configuring, or operating any equipment, Savant recommends that each dealer, integrator, installer, etc. access and read all relevant technical documentation. Savant technical documentation can be located by visiting Savant.com. Vendor documentation is supplied with the equipment.

**Read and understand all safety instructions, cautions, and warnings in this document and the labels on the equipment.**

### Safety Classifications In this Document

<b>NOTE:</b>	Provides special information for installing, configuring, and operating the equipment.
 <b>IMPORTANT!</b>	Provides special information that is critical to installing, configuring, and operating the equipment.
 <b>CAUTION!</b>	Provides special information for avoiding situations that may cause damage to equipment.
 <b>WARNING!</b>	Provides special information for avoiding situations that may cause physical danger to the installer, end user, etc.

### Electric Shock Prevention

 <b>ELECTRIC SHOCK!</b>	The source power poses an electric shock hazard that has the potential to cause serious injury to installers and end users.
 <b>ELECTRICAL DISCONNECT:</b>	The source power outlet and power supply input power sockets should be easily accessible to disconnect power in the event of an electrical hazard or malfunction.

### Weight Injury Prevention

 <b>WEIGHT INJURY!</b>	Installing some Savant equipment requires two installers to ensure safe handling during installation. Failure to use two installers may result in injury.
---	---

## Safety Statements

All safety instructions below must be read, understood, and carefully followed under all applicable circumstances when working with any Savant equipment.

1. **Follow all input power ratings marked on product near power input!**
2. If fuse replacement is required, replacement fuse should match fuse rating marked on the product.
3. Do not use equipment near water.
4. Clean only with dry cloth.
5. Do not block any ventilation openings or install near any heat sources such as heat registers, stoves, radiators, amplifiers, etc.
6. Refer all servicing to qualified service personnel. Servicing is required when any part of the apparatus has been damaged in any way, or fails to operate normally for any reason.
7. Use only attachments/accessories specified by the manufacturer, following all relevant safety precautions for any such attachments/accessories.
8. For applicable equipment, use the included power cord with the grounding prong intact to insure proper grounding of the device.
9. If the provided plug does not fit the desired outlet, contact a licensed electrician to replace the obsolete outlet.
10. Protect any power cord from being walked on, pinched, strained, or otherwise potentially damaged, especially at the outlet or device connections.
11. Disconnect any outlet powered apparatus from its power source during lightning storms or when unused for long periods of time.
12. To completely disconnect equipment from AC mains power, disconnect the power supply cord plug from the AC receptacle on the device.
13. For any hardwired or fixed in-wall apparatus, carefully follow all wiring diagrams and instructions. All electrical wiring and servicing should be performed by a properly licensed electrician.

# 1. Before You Begin

Read this document in its entirety before starting deployment of the product, and ensure that the following required items are available:

- Savant Rack Mountable Host Unique ID (UID) and MAC Address .....   
SHR-S2 or SHR-2000
- da Vinci Runtime for Host upgrade .....   
See table below for minimum supported release.
- Smart Standard License 9.0 or higher .....   
(SHR-S2 license is pre-installed)
- Savant Development Environment (SDE/MacBook®) .....   
See table below for minimum supported version.
- Ethernet network meeting Savant requirements .....   
See [Appendix A: Network Requirements](#)
- Device Features and Zones Supported by Savant Hosts .....   
Refer to the **Host Licensing and Feature Support Matrix** located on the [Savant Customer Community](#) for a list of the available features before starting Blueprint configuration.

## Supported Releases

Device	Minimum Supported Release
SHR-S2-00	da Vinci 9.1.3
SHR-S2-01	da Vinci 9.3.6
SHR-2000-xx	da Vinci 9.2

## 2. Deployment Steps

To successfully deploy a Savant Rack Mountable Host, follow the steps listed below. This page can be used as a checklist to track progress as items are completed.

- Review product specifications and connection details .....   
See the device's Quick Reference Guide on the [Savant Customer Community](#).
- Install the Savant Host .....   
See [Installation](#)
- Update the Savant Host to the latest version of da Vinci .....   
See the [Savant Host Runtime Upgrade Deployment Guide \[da Vinci 9.x\]](#) on the [Savant Customer Community](#) for steps to upgrade the Savant Host.
- Add the Host to a RacePoint Blueprint® configuration .....
- Install an OS Runtime License on the Host .....   
Refer to the [Savant Runtime Operating System Licensing Application Note](#) on the [Savant Customer Community](#).

### 3. Installation

The Savant Host can be installed in a standard National Electrical Manufacturer's Association (NEMA) rack, or on a solid, flat, level surface such as a table, cabinet, or shelf. The location should be dry, well ventilated, and out of direct sunlight.

#### 3.1. Mounting Plate

A mounting plate (074-0577-xx) is supplied with the SHR-S2. This mounting plate is used to mount the Host to a wall or existing structure. To mount the Host, follow the instructions below.

1. Position the mounting plate onto the wall where the Host will be located. Position the bracket so the tabs that hold the Host are positioned horizontally.
2. Mark the two mounting holes on the wall.
3. Install wall anchors and screw mounting plate to the wall.
4. Snap the SHR-S2 Host into the bracket so the tabs on the mounting bracket seat into the slots on the side of the Host.

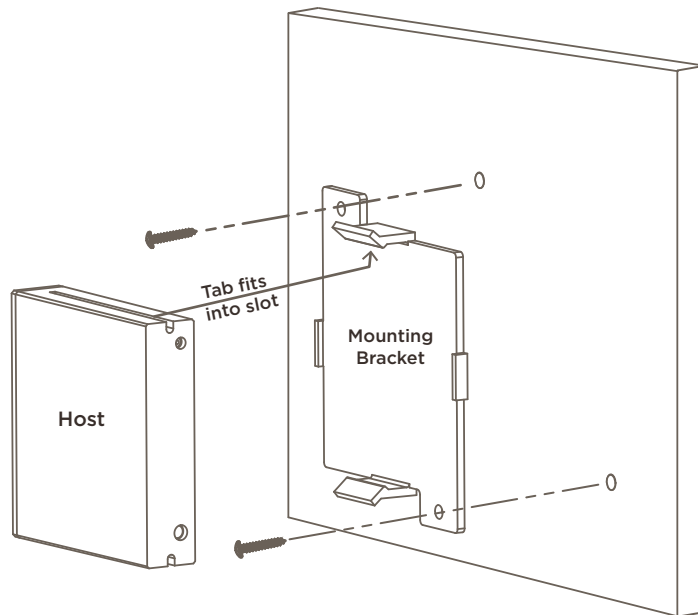

#### 3.2. Rack Mount

The **SHR-S2** can use the optional RCK-3000-xx provides a ventilated shelf for mounting S2 Hosts. This rack is compatible with all standard 19-inch National Electrical Manufacturers Association (NEMA) rack mounts.

The **SHR-2000** can use the optional RMB-PAVAM2F-xx or RMB-PAVAM2-xx allows two devices to be mounted side by side. For example a Smart Host can be mounted next to a PAV-AIM7C. This rack is compatible with all standard 19-inch National Electrical Manufacturers Association (NEMA) rack mounts.

The instructions below show the RMB-PAVAM2F-xx, both brackets install the same way they just face different directions.

1. Align the bracket with the Smart Host mounting points.
2. Attach using the screws provided with the bracket.

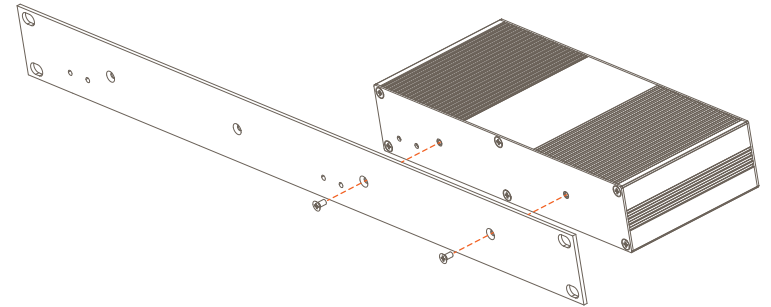

## 4. Wiring and Connections

### 4.1. Power

Savant Hosts use an A/C power connection. Read and adhere to the warnings listed below:



#### **SURGE PROTECTION!**

Use a surge-protected circuit for all components and power supplies requiring 100/240V (AC 50/60 Hz) source power.



#### **ELECTRICAL DISCONNECT!**

The source power outlet and power supply input power sockets should be easily accessible, to disconnect power in the event of an electrical hazard or malfunction.

#### **Power Management Recommendations**

Savant recommends a pure sine wave uninterruptible power supply (UPS) with the ability to gracefully shut down the Savant Host before the battery runs out of power. Never remove power from the Savant Host before shutting it down. See [Appendix B: UPS Recommendations](#) for more information.

### 4.2. Ethernet

#### **Wired Connection**

The Savant Host communicates with other devices on the network via a cat 5e/6/7 Ethernet connection.

For more information on using Ethernet, refer to [Appendix A: Network Requirements](#).

#### **Wireless Connection (SHR-S2 only)**

The S2 Host contains a wireless radio. This device can use used with a wireless connection. Provisioning can be done with the Savant SmartConnect App. For more information see the [SmartConnect Software Reference Guide](#) on the [Savant Customer Community](#).

### 4.3. Audio Output

Savant Hosts include a Digital Optical (TOSlink) audio output for use with the Audio Interrupt Service (AIS). Connection instructions may vary based on the Savant Audio Matrix or 3rd party switcher in use. For more information on configuring an AIS service, refer to the [Audio Interrupt Service \(AIS\) Configuration for Doorbells - Application Note](#), available on the [Savant Customer Community](#)

## 4.4. Control Connections

The Savant Host control connections send data to control a device and receive data to display current status on the user interfaces or trigger a system action. Each port type may support multiple protocols that are determined by the logical connection within Blueprint.



### TIPS:

- Savant recommends that installers plan all control connections and protocols to be used on site prior to any physical configuration or cable construction. This helps to ensure that devices respond effectively to control commands and are not damaged by incorrect cable configuration.
- When installing wire in screw down terminals, strip a 1/4 inch of insulation from each wire and twist the strands together. This will allow for the exposed wire to be inserted into the terminal up to the insulation, eliminating stray strands that may cause shorting.

### RS-232 Wiring

#### Pinout

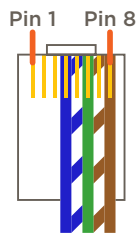

RJ-45 Connector  
(Gold pins facing up)

Pin 1: No Connection
Pin 2: No Connection
Pin 3: No Connection
Pin 4: GND (Ground)
Pin 5: RXD (Receive)
Pin 6: TXD (Transmit)
Pin 7: CTS (Flow Control)
Pin 8: RTS (Flow Control)

#### NOTES:

- CTS/RTS handshaking is supported for flow control based on the profile used in the configuration.
- Wire coloring is included to identify the pins used for this connection. Colors shown do not represent any wiring standard.
- The SHR-S2/2000 Hosts does not support RS-422/485.



**IMPORTANT!** When wiring to this port, **DO NOT** connect any wires within the cable that are not required for communication.

### RJ-45 to DB9 Serial Control Adapters

Refer to the [RS-232 Conversion to DB-9 and RS-422/485 Pinout Reference Guide](#) located on the [Savant Customer Community](#) for more information on RJ-45 to DB9 adapters.



**IMPORTANT!** When using RJ-45 to DB9 adapters not supplied by Savant:

- Ensure that any wires required for communication/control are terminated within the adapter.
- Ensure that all wires NOT required for communication/control are NOT terminated in the connector.
- Ensure that the unused wires in the connector are cut to prevent them from shorting out, as they are still terminated in the RJ-45 connector on the controller side.



## IR Wiring

IR connections are made using 6-pin Screw Down Plug-in Connectors supplied with the Host. The wire slips into the hole and locks with a screw located at the top of the connector.

### Pinout

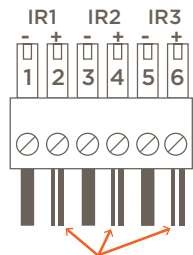

Pin 1:	IR 1 -
Pin 2:	IR 1 +
Pin 3:	IR 2 -
Pin 4:	IR 2 +
Pin 5:	IR 3 -
Pin 6:	IR 3 +



### IMPORTANT! IR Wiring Precautions

- Ensure that all IR emitters are within 15 feet (4.6 meters) of the controller's location.
- Use of 3rd party flashing IR emitters with Talk Back is not recommended. These types of emitters can draw voltage away from the IR signal, resulting in degraded IR performance.

## Relay Wiring

Relay ports are used when a device is controlled via a normally open (NO) or normally closed (NC) relay.

### Pinout

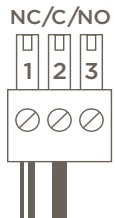

Pin 1:	NC (Normally Closed)
Pin 2:	C (Common)
Pin 3:	NO (Normally Open)

## GPIO Wiring

General Purpose Input/Outputs (GPIO) are binary I/O ports used on Savant controllers to trigger an action within the system. Events can control a device, such as turning on an amplifier (output) or detecting a state change for a device (input) to perform a workflow. Pin 1 is used for input or output depending on the Component Profile used within the Blueprint configuration.

### Pinout

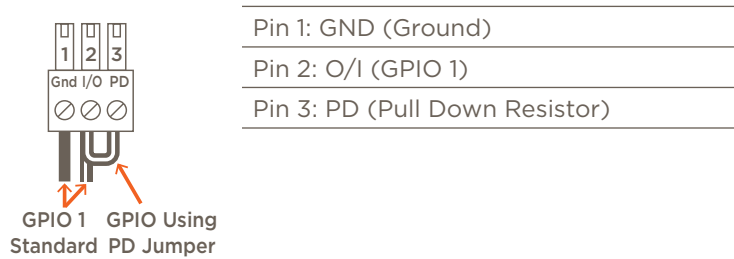

### GPIO Pull Down Resistor (PD) Usage

GPIO pins configured as inputs are pulled high to 12V while the Host is booting up. To make the GPIO signal low (< 0.8V) during a Host reboot and/or a power cycle, attach the GPIO 1 pin to the PD pin. The PD pin is a 1K ohm pull down resistor (to signal ground) which keeps the GPIO output below 0.8V during processor boot times. See item I under Rear Panel for GPIO voltage ratings.

## 5. Blueprint Configuration

When a Blueprint configuration is created, a Host is automatically added to the Zone Component List, however it is not added to the Layout view. The Host for configuration must be placed in the Layout view in order for services to be generated.

**NOTE:** If the Host at the top of the Zone Component List is not an Host with Control the steps outlined in Replacing a Host in a Configuration before adding the Host to the Layout view.

### Required Devices

- SHR-S2 or SHR-2000 Host

### Optional Devices

- IR Controllable Devices
- Serial (RS-232) Controllable Devices
- Contact Closure (Relay) Controllable Devices
- Voltage Trigger (GPIO) Controllable Devices
- IP (Ethernet) Controllable Devices

## 5.1. Replacing a Host in a Configuration

By default, a Savant Pro Host is added to any new RacePoint Blueprint configuration file. When utilizing one of the other varieties of Savant Host, including the SHR-S2, or SHR-2000, the existing Host Profile must be replaced with the one matching the device used on site. The example below shows how to configure the SHR-2000 as the Savant System Host.

1. In an open Blueprint configuration, open the Component Library by navigating to: View > Show Component Library
2. Enter SHR-2000 into the Search field.
3. Select the SHR-2000 profile from the list and drag it onto the Host in the left side Component List.
4. Select Replace when prompted.
5. At the top of the Component List, select the Host and drag it into the Layout Window.
6. Select the Host profile.
7. Open Inspector.
8. Enter a Device Name for the Host.
9. Enter Savant UID for the Host.



### TIPS:

- Savant recommends using the customer's last name and a number unique to the customer followed by Host. Example: Dresden45 Host
- Host names exceeding 20 characters, or utilizing special characters (such as &, %, @, #, etc.) may cause certain types of communication issues, and are therefore not recommended by Savant.

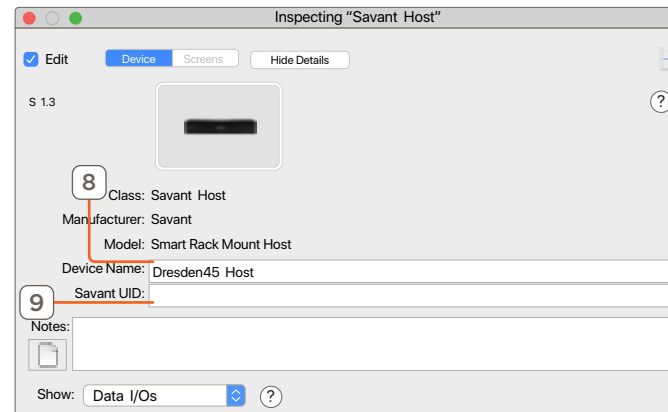
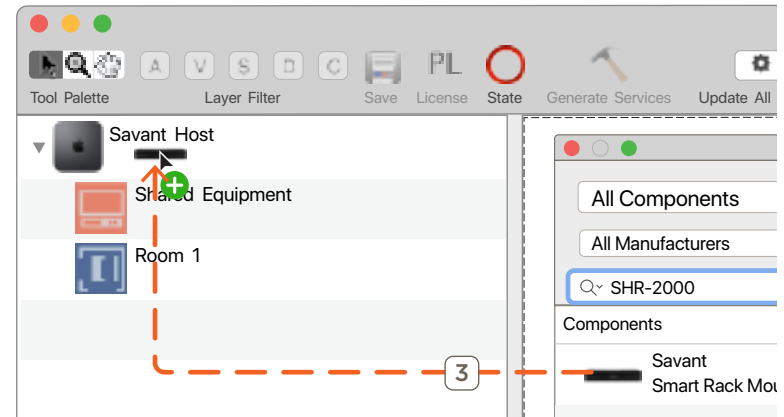

## 5.2. Adding a Host to the Layout Window

This section outlines the process of configuring a SHR-2000 as the system Host when it has already been added as the Host in the component list, or is the default Host for the configuration. The process follows the same steps for other IP Audio Products with Integrated Host..

Follow the steps below:

1. In an open Blueprint configuration, select the Host at the top of the Component List and drag it onto the Layout Window.
2. Enter a unique Device Name and the Savant UID for the Host. The Savant UID is used to identify the Host on the network so that a configuration may be uploaded.
3. Select the Host in the Layout Window and open the Inspector by navigating to:  
View > Show Inspector
4. Enter a Device Name that is unique to the system.
5. Enter the Savant UID for the Host.

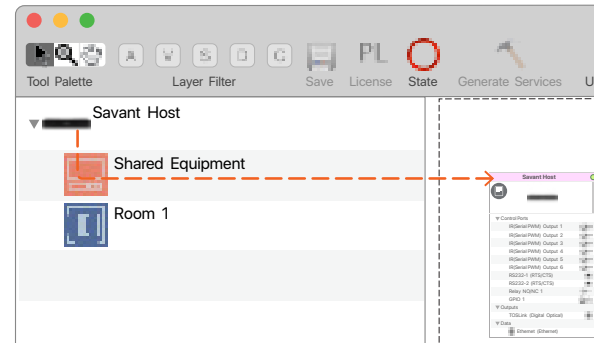

### TIPS:

- Savant recommends using the customer's last name and a number unique to the customer followed by Host. Example: Dresden45 Host
- Host names exceeding 20 characters, or utilizing special characters (such as &, %, @, #, etc.) may cause certain types of communication issues, and are therefore not recommended by Savant.

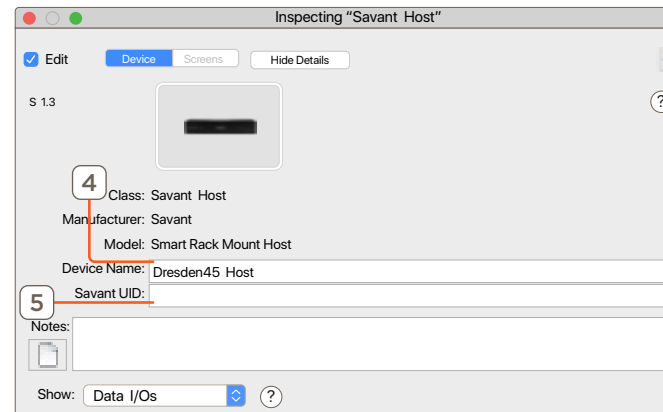

### 5.3. Adding a Doorbell or Door Station

The SHR-S2 AND SHR-2000 Hosts support the Audio Interrupt Service (AIS) which is used to interrupt the currently playing audio with a doorbell chime alerting the user that a doorbell has been pressed. This service requires a connection between the Smart Host and a Savant Audio Matrix or 3rd party audio matrix.

Refer to the [Audio Interrupt Service \(AIS\) Configuration for Doorbells Application Note](#) located on the [Savant Customer Community](#) for information on using AIS.

### 5.4. Use of Custom Automator Workflows and Applescripting

- Only Savant Automator actions, Apple's Pause, or Run Shell Script actions can be used. All other actions will be ignored.

**NOTE:** Functions such as email can be programmed using the Run Shell Script action.

See Setting Up Mail (Gmail Only) for Notifications for more information.

- Applescripting is not supported on SHR-S2/2000 Hosts. Another scripting language and the Savant Command Line Interface Bridge (sclibridge) must be used. See Running Scripts for more details.

## 6. Host Configuration

The Savant SHR-S2 and SHR-2000 Hosts do not offer a graphical user interface (GUI) for configuration. The Terminal command line interface is used to communicate with and configure the Host via Secure Shell (SSH) commands when needed. The section below outlines a number of commonly used SSH commands and their function as it relates to Host configuration.

**NOTE:** This section includes a number of SSH commands which can be input into Terminal or other command line applications. Copying and pasting command syntax directly from this document may result in formatting errors being introduced during the transfer. Check all copied commands carefully to ensure their functionality.

### 6.1. Change the Host User Password

For security purposes, especially with remote access for dealers, Savant is providing a command line utility to easily change the password of the Host.

**NOTE:** Savant recommends passwords be at least 10 characters long and include numbers, symbols, and capital letters.

1. Launch the **Savant Application Manager** (SAM).
2. Select the appropriate da Vinci release for the Host and click **Activate**.
3. Open **System Monitor** by selecting it from the right side menu.
4. In an open System Scanner window, select **Savant Host**.
5. Click **Terminal** in the menu bar to open a session with the selected Host.
6. In the open **Terminal** window type:  
`savantSetPassword`
7. When prompted, enter the current password
8. When prompted, enter the new password
9. Once the password has been changed, reboot the Host to ensure that the security changes are applied to all processes.

### 6.2. Setting Up Mail (Gmail Only) for Notifications

The SHR-S2 and SHR-2000 Hosts can be configured to send notifications via email or SMS text message using a custom workflow within RacePoint Blueprint. For details on configuration, refer to the article titled **How to Send an Email/SMS Text Notification from a Triggered Workflow - Programming Guide**, available on the [Savant Customer Community](#).

### 6.3. Querying and Configuring DNS and IP Address

By default, the Host is set to pull its IP address from DHCP. Changing to a static IP requires the user to access the Host via Terminal.

**NOTE:** DNS addressing can only be set manually for Hosts using a statically assigned IP address. For Hosts set to DHCP, the local router's DNS settings take precedence.

1. Launch the **Savant Application Manager (SAM)**.
2. Select the appropriate da Vinci release for the Host and click **Activate**.
3. Open **System Monitor** by selecting it from the right side menu.
4. In an open **System Scanner** window, select the **Savant Host**.

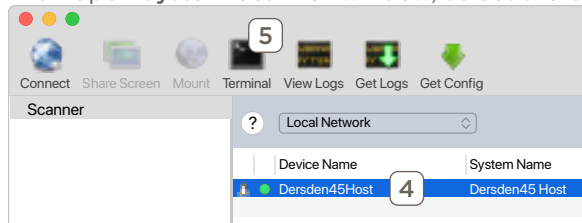

5. Click **Terminal** in the menu bar to open a session to the selected Host.
6. When prompted, enter the password for the Host.  
Default: **RPM**
7. In the open **Terminal** window enter a command to perform from the list below:

For help and supported argument list:

```
setIPAddress --help
```

```
setIPAddress
```

Example of Terminal Window:

```
setIPAddress
```

```
> eth0: setup for DHCP
```

Query the Current Address and Mode:

```
eth0      Link encap:Ethernet HWaddr ec:a8:6b:f6:8b:df
          inet addr:10.0.100.155 Bcast:10.0.100.255 Mask:255.255.255.0
          UP BROADCAST RUNNING MULTICAST MTU:1500 Metric:1
          RX packets:314715 errors:0 dropped:0 overruns:0 frame:0
          TX packets:33460 errors:0 dropped:0 overruns:0 carrier:0
          collisions:0 txqueuelen:1000
          RX bytes:113254559 (108.0 MiB) TX bytes:5705141 (5.4 MiB)
          Interrupt:20 Memory:f7c00000-f7c20000
```

```
setIPAddress -DHCP
```

Set to DHCP:

A message will appear to confirm the requested change. After confirming (y), the connection to the Host will be lost as the IP address has changed. Close the Terminal window after confirming and entering password for Host RPM user.



Set to Static:	<pre>setIPAddress -static -address x.x.x.x -netmask x.x.x.x -gateway x.x.x.x</pre> <p>Substitute x.x.x.x with the appropriate addresses.</p> <p>A message will appear to confirm the requested change. After confirming (y), the connection to the Host will be lost as the IP address has changed. Close the Terminal window after confirming and entering password for Host RPM user.</p>
Add a DNS Server Address to the list:	<pre>setDNSServer -add -address x.x.x.x</pre> <p>Substitute x.x.x.x with the appropriate addresses.</p>
Remove a DNS Server Address from the list:	<pre>setDNSServer -remove -address x.x.x.x</pre> <p>Substitute x.x.x.x with the appropriate addresses.</p>
Query Current DNS Server Information:	<pre>setDNSServer</pre> <p>Example of Terminal Window:</p> <pre>&gt; setDNSServer Current DNS Servers:   servername 8.8.8.8   servername 8.8.4.4</pre>

## 7. Running Scripts

Custom workflows and scripts created within Blueprint are copied to the Host when the configuration is uploaded. However, scripts that are created outside of Blueprint using Automator or Linux will need to be copied to the Host for the system to access them. These items will need to be placed on the Host by using SSH commands.

**NOTE:** This section includes a number of SSH commands which can be input into Terminal or other command line applications. Copying and pasting command syntax directly from this document may result in formatting errors being introduced during the transfer. Check all copied commands carefully to ensure their functionality.

**⚠ IMPORTANT!** S2/2000 Hosts can only run scripts containing Savant Commands, located under **Actions > Other** within **Automator**. Scripts utilizing Applescript or other Mac commands should never be copied to S2/2000 Hosts, as they are not supported, will not function, and may render the system unresponsive.

### 7.1. Recalling Script Files

Scripts added via Blueprint using the Customer Files [bold] folder accessed through the Tools > Customer and Provider Info [bold menu path] dialog are stored in a different location within the Host filesystem for S2/2000 Host types than with a Savant Pro Host.

Refer to **Tools Menu - Channel Listings Editor, Customer and Provider Information: RacePoint Blueprint Programming Guide** located on the [Savant Customer Community](#) for details on adding Customer Files.

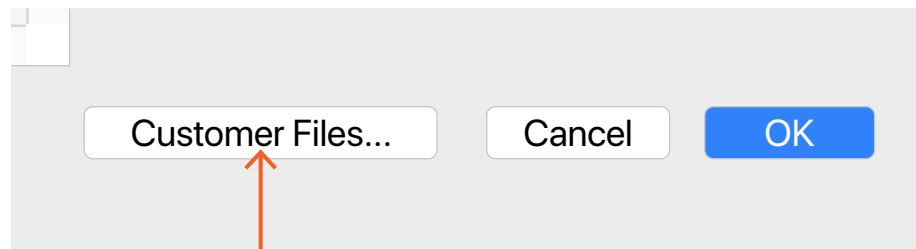

Customer Files folder access in  
Tools > Customer and Provider Info dialog.

Files that have been added to **Customer Files** are located under the following path on the Host:

```
/home/RPM/GNUstep/Library/ApplicationSupport/RacePointMedia/userConfig.rpmConfig/CustomerFiles
```

## 7.2. Executing Scripts on the Host

Custom scripts, workflows, and other programming can be executed on Savant Hosts using sclibridge, a command line utility used to interact directly with the Savant Host via Terminal for advanced customization.

When using an SHR-S2, SHR-2000, or other Linux-based Hosts, the sclibridge utility is located within the Host filesystem in the directory shown below:

```
/usr/local/bin/sclibridge
```

This is different from the location of the utility for Savant Pro, Super Pro, or any other MacOS-based Host, and should be kept in mind when writing or testing any such scripts or workflows.

A standard UNIX utility can be used to determine the platform any script is running on, and adjust accordingly. See example below for reference:

```
#!/usr/bin/perl -w

$osType = `uname`;
chomp($osType);

$sclibridge = undef;

if($osType eq "Linux OS")
{
    print "Running on Linux\n";
    $sclibridge = "/usr/local/bin/sclibridge";
}
elseif($osType eq "Mac OS")
{
    print "Running on Darwin\n";
    $sclibridge = "/Users/RPM/Applications/RacePointMedia/sclibridge";
}
else
{
    print "Running on Unknown: $sclibridge\n";
}
}
```

## 8. Troubleshooting

The subsections below contain information related to software tools and processes which can be helpful for troubleshooting potential Host-related issues in the field. For further troubleshooting assistance, check the Savant Customer Community Knowledge Base, or submit a case with Savant Support for direct technical assistance.

### 8.1. Retrieving Logs

When troubleshooting undesirable behavior in a deployed Savant system, retrieving logs from the Host can be particularly useful, especially in cases where the problem can be reproduced and an accurate timestamp can be provided to Savant Support. Host logging contains a record of the actions, messages, service requests, state changes, and more processed by the Host. Follow the steps below to retrieve Host logs:

1. Launch the Savant Application Manager (SAM) on the SDE, and click **Activate** next to the desired release if necessary.
2. Open System Monitor by selecting it in the right side menu.
3. Select the Savant Host in the list.

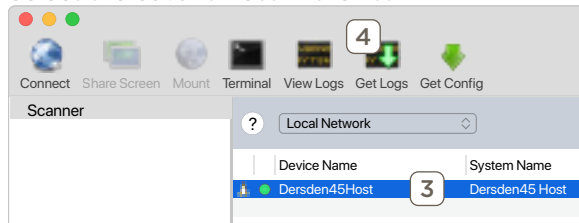

4. Click **Get Logs** on the top menu bar.
5. A dialog window with options for saving the log files will open, as shown in the example image below.
6. Save As: Select a name that identifies the file.  
Example: Dresden45Host\_2019-12-25-102552\_DiagnosticReports

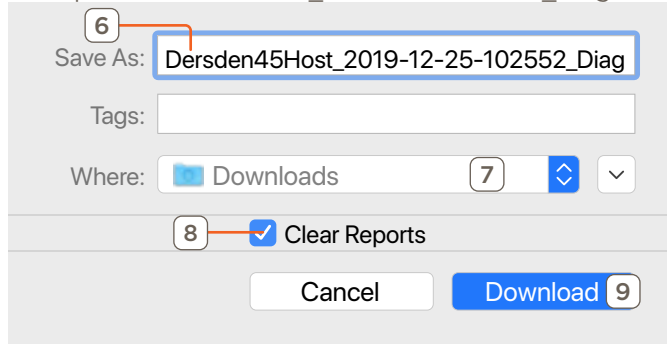

7. Select a location within the SDE filesystem to save the logs to.
8. Clear Reports: When checked, all reports on the Host will be cleared after saving the log file.
9. Click **Download** to transfer and save the report.

## 8.2. Stopping and Starting the Host

Stopping and starting the runtime software can often be a useful step during troubleshooting. This can be done via System Monitor, or through a Terminal command line session.

### Restart Runtime via System Monitor Process Tab

1. Launch the **Savant Application Manager (SAM)**.
2. Select the appropriate da Vinci release for the Host and click **Activate**.
3. Open **System Monitor** by selecting it in the right side menu.
4. In an open **System Scanner** window, select the **Host**.
5. Click **Connect**, or double-click the selected Host.
6. In an open **System Dashboard** window, select the **Processes** tab on the left.
7. In the **Remote Management** section, select **Soft Reboot** to restart the runtime software.

### Stopping the Host via System Monitor Processes Tab

**NOTE:** Before stopping the Host using this method, write down the IP Address so that it can be restarted using the Command Line method below.

1. Launch the **Savant Application Manager (SAM)**.
2. Select the appropriate da Vinci release for the Host and click **Activate**.
3. Open **System Monitor** by selecting it in the right side menu.
4. In an open **System Scanner** window, select the **Host**.
5. Click **Connect**, or double-click the selected Host.
6. In an open **System Dashboard** window, select the **Processes** tab on the left.
7. In the **Remote Management** section, select **System Stop** to stop the Host.

### Stopping and Starting via Command Line

1. Launch the **Savant Application Manager (SAM)**.
2. Select the appropriate da Vinci release for the Host and click **Activate**.
3. Open **System Monitor** by selecting it in the right side menu.
4. In an open **System Scanner** window, select the **Host**.
5. Click **Terminal** in the menu bar to open a session on the selected Host.
6. At the command prompt, type one of the following commands:
  - `stopSavantSystem`
  - `startSavantSystem`

### 8.3. Uploading Configuration to the Host

To upload a Blueprint configuration to a Savant Host, the recommended methods are to use either the **Upload to Master** button from the main Blueprint taskbar, or the **Upload** button in System Monitor. If neither of these methods are available for any reason, configuration files can be uploaded to the Host via the command line following the steps listed below.

1. Launch the Savant Application Manager (SAM).
2. Select the appropriate da Vinci release for the Host and click Activate.
3. Open System Monitor by selecting it in the right side menu.
4. In an open System Scanner window, select the Savant Smart Host.
5. Click Upload to start the upload process.
6. Click Browse and then navigate to the SDE folder containing the configuration file to upload.
7. Select the configuration file in the folder and click Open.
8. In the open dialog showing the selected file, click Upload.

### 8.4. Copying the Configuration File to the SDE

The preferred method for downloading configurations to the SDE is using the **Get Config** button in System Monitor.

1. Launch the Savant Application Manager (SAM) on the SDE, and click **Activate** next to the desired release if necessary.
2. Open **System Monitor** by selecting it from the right side menu.
3. Select the **Host** from the list.

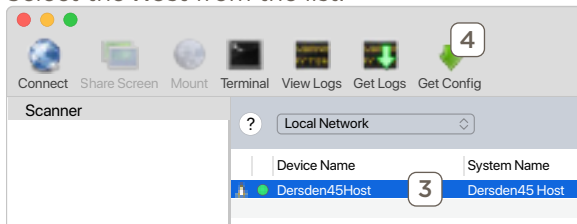

4. Click **Get Config** on the top menu bar.
5. A dialog window will open to save the configuration file that provides the following options:
6. Save As: Select a name that identifies the file.  
Example: SmartHost\_2016-03-22-102552\_config.tgz

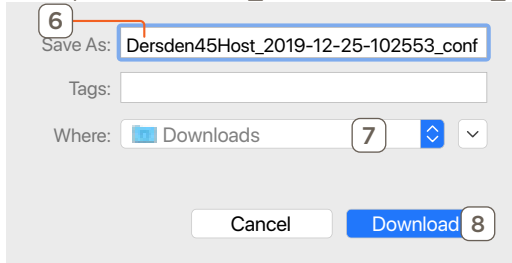

7. Where: Location to Save the configuration.
8. Download: Click to download the configuration.

## Appendix A: Network Requirements

Savant requires the use of business class/commercial grade networking equipment throughout the network to ensure the reliability of communication between devices. These higher quality components also allow for more effective troubleshooting when needed.

### Device Network Connections

Connect all Savant devices to the same local area network (LAN) or subnet as the Host. Savant recommends the implementation of a flat network topology for all Savant devices. Use of network utilities such as band steering, packet shaping, QoS, or fast roaming (802.11r), etc. may interfere with performance.

### Managing IP Addresses

To ensure that IP addresses will not change due to a power outage, a static IP Address or DHCP reservation should be configured for the Savant Host and all other Savant or Savant-controlled devices. Savant recommends using DHCP reservation within the router. By using this method, static IP addresses for all devices can be managed from a single UI, avoiding the need to access devices individually.

### Setting DHCP Reservation

Setting DHCP reservation varies from router to router. Refer to the documentation for the router to configure DHCP reservation.

### Network Changes

Savant recommends performing the following steps to refresh the IP connection after connecting to a new network, changing routers, or if the IP Address range is changed in the current router. This will reset any IP connection and ensure that the Host is communicating with the network correctly.

- Hot Plug the Ethernet (LAN) Connection
  1. Disconnect the Ethernet (LAN) connection from the Host.
  2. Wait 15 seconds and then reconnect.

### Network Guidelines

See the [Savant Device Networking Guidelines](#) topic on the [Savant Customer Community](#) for networking recommendations.

## Appendix B: UPS Recommendations

Savant does not recommend any brand or model UPS, however there are a couple of factors that should be considered. It is important that the UPS does not only work during complete power loss but protects devices and their functionality during events like surges and brownouts. It is not uncommon for a residence or small business to see variations in power service that do not result in a complete black-out. These periods can be the most frustrating to end users as they do not realize what the cause of the operation disturbance may be.

Below are some specific design considerations when assembling your power management designs.

- Pure Sine Wave Inverter.
- Online/double-conversion power supply: This type of UPS always supplies power to the equipment this will eliminate any period where the power is interrupted. This will also address many issues if the site has regular “brown outs” or if the site has frequent under or over voltage situations.
- Max power output: The UPS needs to be properly sized for the equipment connected to it, and unnecessary loads should not be included on the UPS. For instance, putting an audio amplifier on the UPS will either drive up the cost of the UPS system to support the load or drastically shorten the period that the UPS can keep devices up and running.  
Remember to consider devices that you may not have directly installed, for instance modems, routers, switches, APs, PoE injectors, and the like. This is especially important if you are using software that relies on the network for communication. Power cycling segments of the network can cause network conflicts. It is important to consider this during your network design and configuration to ensure that there is the greatest likelihood of success.
- “Graceful” shut down: The UPS should communicate with the devices connected to it so that when necessary they are properly shut down. Many UPS manufacturers offer a software suite so that hard-drive based devices may go through a ‘graceful’ shut down procedure. This feature should be vetted in a test environment prior to implementation so that the integrator understands how the system will respond during shutdown and start-up periods.
- Power consumption monitoring.  
It is nice to have the ability to monitor the draw from each outlet to determine if an item is running through a remote console.
- Remote Access: The ability to remotely power cycle an outlet or a group of outlets.



- IMPORTANT!** Be VERY CAUTIOUS using with a UPS with the ability to cycle power an outlet remotely, devices with hard drives DO NOT like to be power cycled in this manner, and will be damaged by this action. Savant Hosts in particular need to be shut down correctly in order to restart correctly when power is restored.
- Generators: Generators are not a replacement for a UPS and should be considered as an augment to the UPS. Having a generator on site increases the need for a UPS because the equipment needs greater protection from power cycles when the generator comes online during testing. A generator is also likely to introduce electrical conditions like under and over voltage or frequency modulation while running. All of these circumstances stress power supplies and hard drives increasing the odds of premature failure.

Savant does have a variety of IP & Serial controlled UPS devices currently profiled (these can be found under Trigger Devices).

- The UPS profiles are designed to give the integrator a set of variables and triggers to perform actions with. The Savant User Interface has no default screen(s) that will auto populate for any of these devices.
- For feedback: All devices support a variety of different state information so make sure to put the device in an example configuration and check what states you can use as a trigger to make sure the profile supports the information you require. The easiest method to accomplish this is to add the desired device to a configuration, make the necessary control connection, generate services, create a new trigger (Tools->Review->State Triggers...), add a transition condition then select the UPS device under the component tab. This will show you all of the states that profile supports in the “State Name” table.
- For Control: Since many devices have different configurations as to what outlets shut off together etc. Savant recommends that you use a CPT kit and test the control commands prior to install to verify it is possible to accomplish the automation task which is proposed.



# Important Notice

## Disclaimer

Savant Systems, Inc. reserves the right to change product specifications without notice, therefore, the information presented herein shall not be construed as a commitment or warranty.

Savant Systems, Inc. shall not be liable for any technical or editorial errors or omissions contained herein or for incidental or consequential damages resulting from the performance, furnishing, reliance on, or use of this material.

## Patents

Certain equipment and software described in this document is protected by issued and pending U.S. and foreign patents.

All products and services are trademarks or registered trademarks of their respective manufacturer.

## Copyright

This document contains confidential and proprietary information protected by copyright. All rights reserved. Copying or other reproduction of all or parts of this document is prohibited without the permission of Savant Systems.

## Trademarks

© 2021 Savant Systems, Inc. All rights reserved. Savant, Savant App, Truelmage, Savant Host, Now You Can, RacePoint Blueprint, Single App Home, TrueCommand, TrueControl, and the Savant logo are trademarks of Savant Systems, Inc.

AirPlay, Apple, AirPort Express, AirPort Extreme, Apple TV, Apple Remote Desktop, FireWire, iMac, iTunes, iPad, iPad mini, iPad Air, iPhone, MacBook, Mac and OS X are trademarks or trade names of Apple Inc. iOS is a trademark of Cisco®. Android, Google, Google Play, and other Google marks are trademarks of Google, Inc. Wi-Fi is a registered trademark of the Wi-Fi Alliance®. HDMI® is a trademark of HDMI Licensing, LLC. MOTU® is a registered trademark of Mark of the Unicorn, Inc. Luxul is a registered trademark of Luxul Wireless. NETGEAR®, the NETGEAR Logo and ProSAFE are trademarks of NETGEAR, Inc. Extreme™ is a trademark of Extreme Networks, Inc.

All other brand names, product names, and trademarks are the property of their respective owners.

## Technical and Sales Support

Savant Systems, Inc is dedicated to providing prompt and effective support in a timely and efficient manner.

- To contact Savant Support, access the [Savant Customer Community](#) and enter a support Case ticket.
- To contact Savant Sales, visit Savant.com and select Contact Us to locate a local sales representative in your area.