

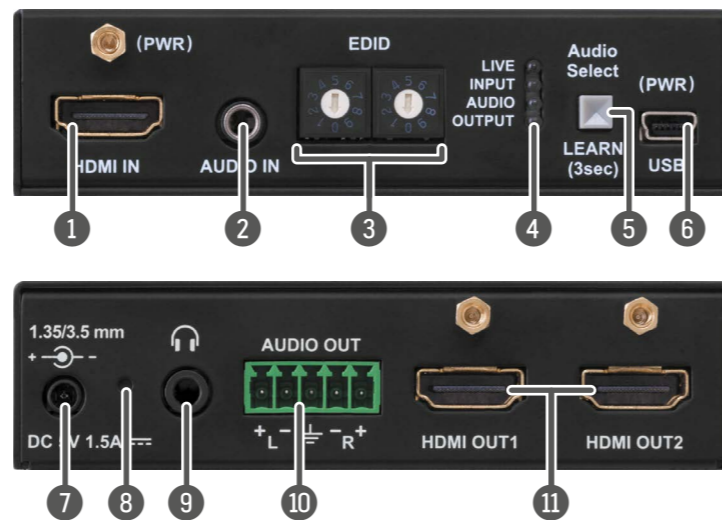

Quick Start Guide

DA2HDMI-4K-Plus-A
DA2HDMI-4K-Plus

Front and Rear Views



1 DA2HDMI-4K-Plus does not contain Analog audio connectors.

⚠ Never use a third-party power supply but the supplied one or use Lightware's rack-mountable power supply unit with the appropriate DC-DC cable.

Legend

- 1 **HDMI Input** HDMI input port for sources and for supplying the device with power (depends on source capabilities). The applied cable shall not be more than 20 m (4Kp30) or 30 m (1080p60).
- 2 **Audio Input** 3.5 mm jack connector for asymmetric analog audio signal.
- 3 **Rotary Switches** Selecting one of the EDID memory addresses.
- 4 **Status LEDs** The LEDs display information about the signal states.
- 5 **Learn Button (Audio Select)** Store the EDID of the sink on HDMI OUT1, start the device in Bootload mode, or toggle between the audio sources.
- 6 **USB Control** USB mini-B type connector to access special settings, perform a firmware upgrade and supply the unit with power. Input for the supplied power adaptor.
- 7 **DC Input** Button for restarting the unit.
- 8 **Hidden Button** Button for restarting the unit.
- 9 **Phones** 3.5mm jack output connector which is the same as the Analog Audio Output (Phoenix).
- 10 **Audio Output** 5-pole Phoenix connector for balanced analog audio; the signal is de-embedded from the HDMI outputs.
- 11 **HDMI Outputs (mirrored)** Identical video output ports. Connect an HDMI cable between the sink and the unit.

Front Panel LEDs

LIVE

- BLINKING (slow): the device is powered properly and operational.
- BLINKING (fast): the device is in Bootload mode.
- ON: shows the malfunction of the CPU; please restart the device.

INPUT

- ON (orange): source is connected (5V detected).
- ON (green): signal is present.

AUDIO

- ON (blue): analog audio input is selected to be embedded in the video stream.
- ON (red): HDMI, multichannel / compressed audio signal is detected.
- ON (purple): HDMI, PCM 2 channel audio signal is detected.
- BLINKING: autoselect is enabled.
- OFF: no audio is transmitted.

OUTPUT

- ON (orange): hotplug detected on HDMI OUT1.
- ON (yellow): hotplug detected on HDMI OUT2.
- ON (green): hotplug detected on HDMI OUT 1 and HDMI OUT 2.

Important Safety Instructions

Please read the supplied safety instruction document before using the product and keep it available for future reference.

Introduction

DA2HDMI-4K-Plus-A is a multifunctional distribution amplifier with the built-in Advanced EDID Management and Pixel Accurate Reclocking, supporting DVI and HDMI 1.4 signals with or without HDCP encryption. The output signal is reclocked and stabilized using Lightware Pixel Accurate Reclocking technology to remove jitter caused by long cables or poor quality sources.

Box Contents

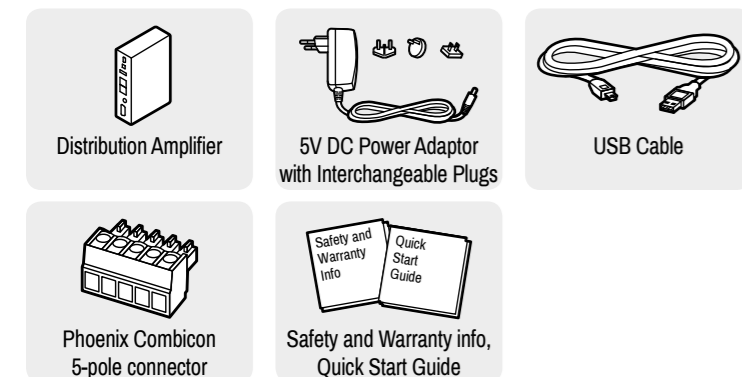

Installation



- 1 Connect the desired source to the **HDMI input** port.
- 2 Optionally connect an audio source to the **Audio input** port.
- 3 Connect one or two sink device(s) to the **HDMI output** port(s).
- 4 Optionally connect an audio device (e.g. amplifier) to the **Phoenix Audio output** port.
- 5 Optionally connect a headphone to the 3.5 mm **Jack Audio output** port.
- 6 Optionally connect a laptop or PC to the **USB** port and run LDC software.
- 7 Connect firstly the power cord of the supplied adaptor to the **DC input**, then secondly to the AC power socket.

EDID Emulation

Selecting an EDID

Turn the EDID address rotary switches to the desired position. Use a flat head screwdriver to change the address. The left switch sets the tens value, the right switch gives the ones value of the EDID.

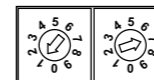

⚠ Avoid the use of keys, coins, knives and other sharp objects.

EDID Learning (OUTPUT LED)

The EDID of the sink connected to HDMI OUT 1 can be stored in the user EDID memory:

1. Turn the EDID rotary switches to the desired position (between #62 - #98).
2. Press the LEARN button and keep it pressed for three seconds.
3. The OUTPUT LED turns to dark for a second then provides feedback:
 - BLINKING (green): EDID learning is successful, the EDID is stored.
 - BLINKING (red): EDID learning is failed.
4. The LED turns to dark for a second, then shows the state(s) of the connected sink(s).

⚠ Please note that the EDIDs stored in the User EDID memory are deleted when the factory default settings are restored.

Further EDID Options

The following functions are available when connecting to the device by LDC:

- EDID learning or importing an EDID, deleting an EDID (from the user memory).
- Exporting an EDID and saving it as a file.
- Creating a custom EDID by using the EDID Editor or the Easy EDID Creator.

EDID Memory Structure

01-11: DVI EDIDs; 12-55: HDMI EDIDs

ID	Resolution	ID	Resolution	ID	Resolution	ID	Resolution
00	Copy HDMI1	14	640x480p59	28	1920x1080i50_2	42	3440x1440p24
01	640x480p60	15	720x480p59	29	1920x1080i60	43	3440x1440p30
02	800x600p60	16	720x576p50	30	1920x1080i60	44	2560x1600p60
03	1024x768p60	17	1280x720p50	31	1920x1080p24	45	2560x2048p50
04	1280x768p50	18	1280x720p60	32	1920x1080p30	46	3840x2160p24
05	1280x768p60	19	1024x768p60	33	1920x1080p50	47	3840x2160p30
06	1280x1024p50	20	1366x768p60	34	1920x1080p60	48	3840x2160p60
07	1280x1024p60	21	1280x800p60	35	1920x1080p60	49	4096x2160p24
08	1600x1200p50	22	1440x900p60	36	2048x1080p60	50	4096x2160p30
09	1600x1200p60	23	1600x900p60	37	2560x1080p60	51	4096x2160p60
10	1920x1200p50	24	1280x1024p50	38	1600x1200p50	52	3840x2400p24
11	1920x1200p60	25	1280x1024p60	39	1600x1200p60	53	3840x2400p30
12	1440x480i60	26	1440x1080p60	40	1920x1200p60	54	720p60_3D
13	1440x576i50	27	1920x1080i50_1	41	2560x1440p60	55	1080p60_3D

ID	Description	ID	Description
56	Universal DVI	60	Universal HDMI 4K PCM AUDIO
57	Universal HDMI PCM AUDIO	61	Universal HDMI 4K ALL AUDIO
58	Universal HDMI ALL AUDIO	62-98	User EDIDs
59	Universal HDMI DC ALL AUDIO	99	Copy HDMI2

Powering Options

The device can be powered by any of the following ways:

- Using the supplied **power adaptor** (recommended).
- Connect the device to a proper **USB port** by the supplied cable.
- Connecting an **HDMI source** to the HDMI input port.

⚠ Make sure that the port is able to supply 5V 500 mA current.

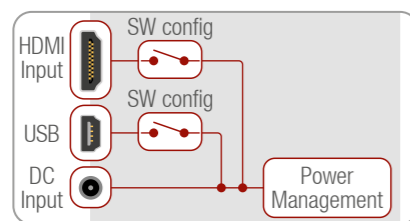

If the power adaptor is connected, it will supply the device independently from the HDMI/USB ports. If the adaptor is disconnected from the DC input connector the device tries to use a different power source (HDMI or USB) if it is enabled and connected. (If the adaptor is unplugged from the AC socket but the DC plug is still connected, the device will be switched off and cannot be changed to another power source. Unplug the DC cable from the device to be powered by USB or HDMI.)

⚠ The USB and HDMI powering modes can be enabled/disabled via LDC software.

⚠ If you are not sure that your USB or HDMI port has enough power, disable the powering over USB and HDMI by Lightware Device Controller software. If the supplied power over USB or HDMI is not enough the device will switch off. In the case of any strange behavior of the device, please disconnect the USB and HDMI cables and connect the 5V DC adaptor.

Port Diagram

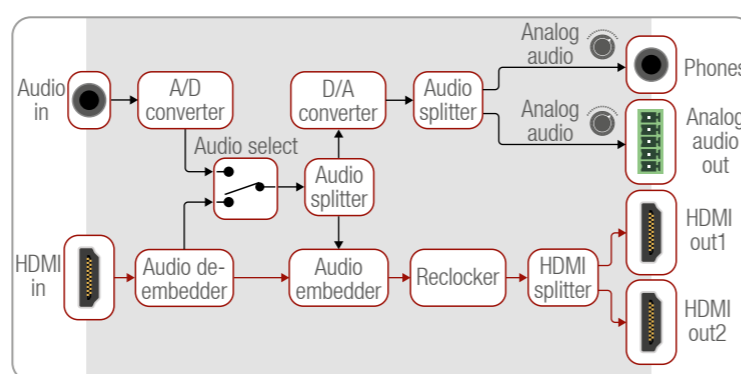

Audio Selection (only on Plus-A variant)

Press the Audio select (LEARN) button to toggle the audio options:

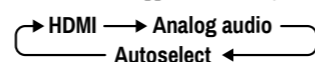

The device is able to select an audio source automatically: activate the Autoselect mode by the Audio select button. In this case the Analog input port has higher priority: if the Autoselect mode is active and a 3.5mm Jack plug is connected to the Audio input port, it will be embedded in the HDMI stream.

HDCP Management

The HDCP setting of the HDMI input port can be enabled/disabled on the front panel as follows:

1. Turn the EDID rotary switches to '01' position.
2. Press the LEARN button and keep it pressed for three seconds.
3. The lower three LEDs give displays if the HDCP state is changed:

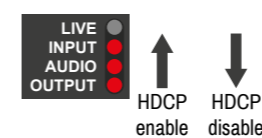

- HDCP is **enabled**: LEDs are dark and light up sequentially.
- HDCP is **disabled**: LEDs light and get dark sequentially.

Further Information

The document is valid with the following firmware version: 1.0.0
The Product brief and further information are available on www.lightware.com.
See the [Downloads](#) section on the dedicated product page.

Contact Us

sales@lightware.com
+36 1 255 3800

support@lightware.com
+36 1 255 3810

Lightware Visual Engineering LLC.
Péterdy 15, Budapest H-1071, Hungary

Software Control – Using Lightware Device Controller (LDC)

The device can be controlled from a computer using the Lightware Device Controller software. The application is available at www.lightware.com (Support / Downloads section), install it on a Windows PC or a macOS and connect to the device.



Connecting by the USB Port

Connect the supplied USB cable between the device and the computer and start the LDC. The device is displayed under the **USB devices** section; select it then press **Connect**.

Crosspoint Menu

When LDC connects to the device, the Crosspoint menu is shown as default. The input and output port settings are available separately for the video and audio signals. Besides, the following tools are available:

Frame Detector

The ports can show detailed information about the signal like blanking intervals and active video resolution. This feature is a good troubleshooter if compatibility problems occur during system installation.

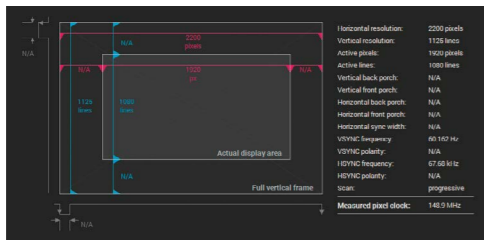

Test Pattern Generator

The output ports can send a special image towards the sink devices for testing purposes. The settings of the test pattern are available via LDC:

Mode

- **On:** the test pattern is always sent to the output port.
- **Off:** the test pattern generator is off.
- **No signal:** the test pattern generator is switched on if video signal is not detected.

Clock Source

- 480p / 576p / Original video signal: the clock frequency of the test pattern.

Pattern

- Red / Green / Blue / Black / White / Ramp / Chess / Bar / Cycle. Cycle setting means all the patterns are changed sequentially approx. in every 2 seconds.

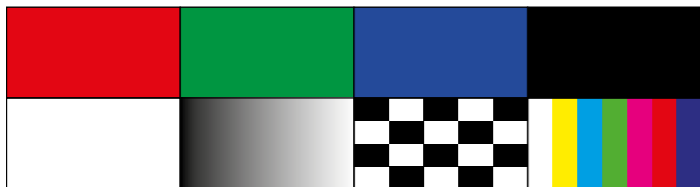

EDID Management

Advanced EDID Management can be accessed by selecting the EDID menu. The software allows to create, modify, delete, import, or export EDIDs. Please note that the factory presets cannot be modified.

EDID emulation is available only by the EDID rotary switches on the device.

Backup and Restore (Configuration Cloning)

This simple method eliminates the need to repeatedly configure certain devices to have identical (non-factory) settings. If the devices are installed in the same type of system multiple times then it is enough to set up only one device to fit the user's needs and then copy those settings to the others, thus saving time and resources. Installing multiple devices with the same customized configuration settings can be done in a few easy steps:



1. Configure one device with all your desired settings with the LDC software.
2. Backup the full configuration file to your computer.
3. If needed, make some modifications to the configuration file using a text editor.
4. Connect to the other device which has to be configured and upload (restore) your configuration file.

Typical Application Diagrams

Daisy Chain System

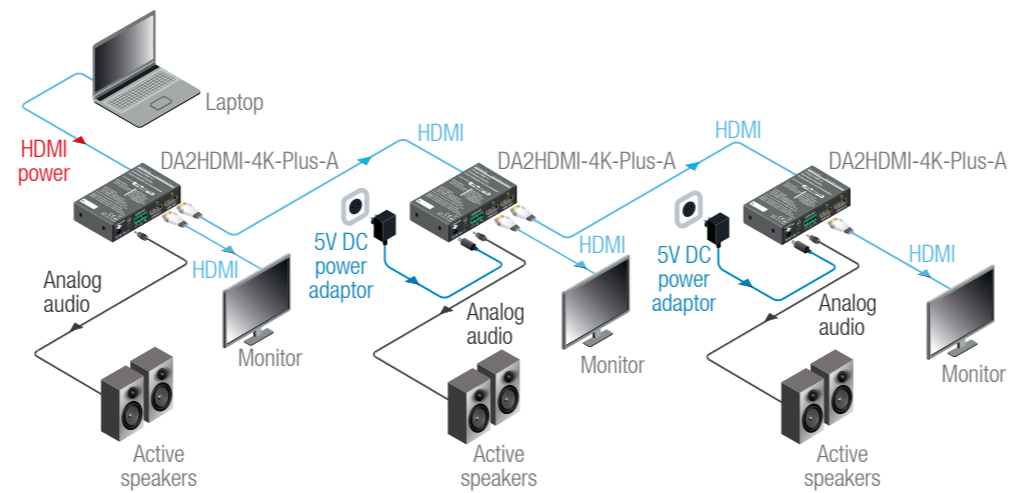

Standalone Application

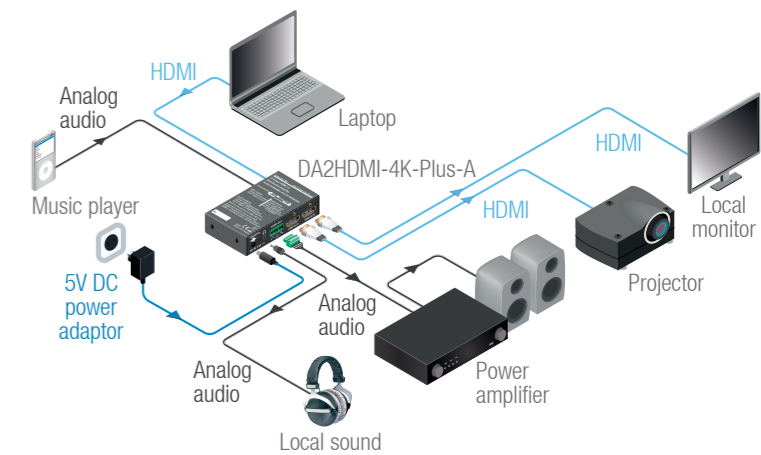

Specifications

General

Compliance	CE
Safety	EN 62368-1:2014
EMI / EMC	EN 55024 / EN 55032
Cooling	passive

Power

Power supply	external power adaptor / USB port / HDMI input port
Power adaptor	Input 100-240 V AC 50/60 Hz, Output 5V DC, 3 A
Power consumption	1.8 W (max)

Digital Video Signal

HDMI connector	19-pole HDMI Type A receptacle
Supported signals	DVI 1.0, HDMI 1.4
Signal standard	DVI and HDMI standard which supports embedded audio
Supported resolutions	up to 4K / UHD (30Hz RGB 4:4:4, 60Hz YCbCr 4:2:0)
3D support	yes
HDCP compliant	yes
Control over CEC	yes, transparent
Audio support	local audio embedding and de-embedding
Reclocking	Pixel Accurate Reclocking
Cable length (input port)	max 20 m (4Kp30) or 30 m (1080p60)

Analog Audio Ports

Signal type	analog stereo, symmetric or asymmetric
Connector type	3.5 mm Jack connector
	5-pole Phoenix connector

Signal Level (input port)

Volume	between -95 and 0 dB
Balance	0 - 100 (50 = center)
Gain	0 - 6.00 dB

Signal Level (output port)

Volume	between -57 and +6 dB
Balance	0 - 100 (50 = center)

EDID Management

EDID emulation	yes
EDID memory	61 factory presets, 37 user-programmable

Control

USB port	USB mini-B receptacle
----------	-----------------------

Restoring the Factory Default Settings

The settings and parameters can be set to factory default as follows:

1. Set the rotary switches to '00' position.
2. Press and keep pressed the LEARN/Audio select button for three seconds. When the lower three LEDs blink, release the button. The following settings and parameters are restored:

HDCP (input port)	enabled
HDCP (output port)	auto
HDMI mode (output port)	auto
HDMI output port (audio signal)	unmuted
Autoselect	enabled
Test pattern generator	off
User EDID memory	cleared

Audio Cable Wiring Guide

The device is built with 5-pole Phoenix connector so we would like to help users assembling their own audio cables. See the most common cases below.

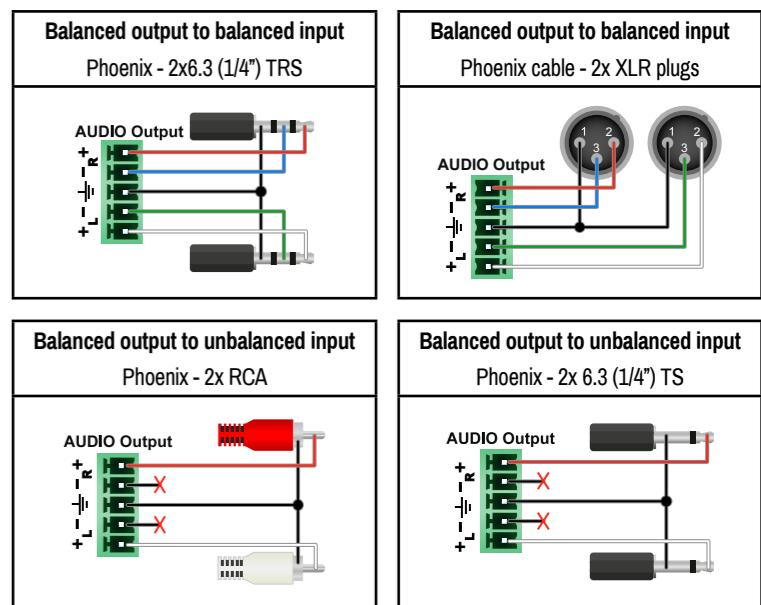

For more information about audio cable wiring see the user's manual of the device or the Audio Cable Wiring Guide on our website www.lightware.com.

Firmware Upgrade – Using Lightware Device Updater (LDU)

Preparation

The following are necessary to perform a firmware upgrade:

- Lightware Device Updater software - available on www.lightware.com,
- Firmware package of the device (LFP file) - please contact support@lightware.com.
- Power adaptor to supply the device.



Performing the Upgrade

The device must be supplied with the power adaptor when the firmware is upgraded. Supplying the device over USB or HDMI is not recommended for this process.

1. Connect a PC/laptop to the USB port of the device by the supplied USB cable.
2. Start the LDU software and follow the instructions shown on the screen.

Starting the Unit in Bootload Mode

If the usual firmware upgrade cannot be performed for any reason, try the following:

1. Press the LEARN button and keep it pressed.
2. Press and release the hidden button.
3. Release the LEARN button. The device is restarted in bootload mode. The LIVE LED blinks fast.