

visual engineering
LIGHTWARE

User's Manual



MMX6x2-HT200
MMX6x2-HT210
MMX6x2-HT220

Multimedia Matrix Switcher

Important Safety Instructions

Class I Apparatus Construction.

This equipment must be used with a mains power system with a protective earth connection. The third (earth) pin is a safety feature, do not bypass or disable it. The equipment should be operated only from the power source indicated on the product.

To disconnect the equipment safely from power, remove the power cord from the rear of the equipment, or from the power source. The MAINS plug is used as the disconnect device, the disconnect device shall remain readily operable.

There are no user-serviceable parts inside of the unit. Removal of the cover will expose dangerous voltages. To avoid personal injury, do not remove the cover. Do not operate the unit without the cover installed.

The appliance must be safely connected to multimedia systems. Follow instructions described in this manual.

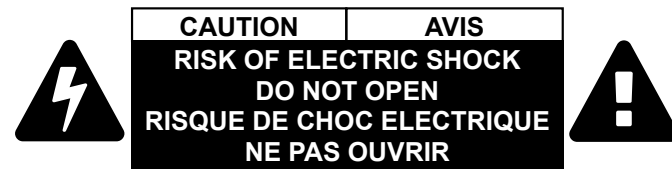

Replacing the AC fuse

Unplug the AC power cord from the device. Locate the AC fuse on the rear panel. Replace only the AC fuse as indicated on the rear panel. Connect the power cord to the switcher and to the AC power source. Make sure the switcher is working properly.

Ventilation

For the correct ventilation and to avoid overheating ensure enough free space around the appliance. Do not cover the appliance, let the ventilation holes free and never block or bypass the ventilators (if any).

WARNING

To prevent injury, the apparatus is recommended to securely attach to the floor/wall or mount in accordance with the installation instructions. The apparatus shall not be exposed to dripping or splashing and that no objects filled with liquids, such as vases, shall be placed on the apparatus. No naked flame sources, such as lighted candles, should be placed on the apparatus.

Waste Electrical & Electronic Equipment WEEE

This marking shown on the product or its literature, indicates that it should not be disposed with other household wastes at the end of its working life. To prevent possible harm to the environment or human health from uncontrolled waste disposal, please separate this from other types of wastes and recycle it responsibly to promote the sustainable reuse of material resources. Household users should contact either the retailer where they purchased this product, or their local government office, for details of where and how they can take this item for environmentally safe recycling. Business users should contact their supplier and check the terms and conditions of the purchase contract. This product should not be mixed with other commercial wastes for disposal.



Common Safety Symbols

Symbol	Description
	Alternating current
	Protective conductor terminal
	On (Power)
	Off (Power)
	Caution, possibility of electric shock
	Caution

Symbol Legend

The following symbols and markings are used in the document:

WARNING! Safety-related information which is highly recommended to read and keep in every case!

ATTENTION! Useful information to perform a successful procedure; it is recommended to read.

INFO: A notice which may contain additional information. Procedure can be successful without reading it.

DEFINITION: The short description of a feature or a function.

TIPS AND TRICKS: Ideas which you may have not known yet but can be useful.

Navigation Buttons

 Go back to the previous page. If you clicked on a link previously, you can go back to the source page by clicking the button.

 Navigate to the Table of Contents.

 Step back one page.

 Step forward to the next page.

Document Information

All presented functions refer to the indicated products. The descriptions have been made during testing these functions in accordance with the indicated Hardware/Firmware/Software environment:

Item	Version
Lightware Device Controller (LDC) software	1.26.0b6
Lightware Device Updater (LDU2) software	2.2.0b7
Firmware package	1.1.5b11
Hardware	1.2

Document revision: **3.3**

Release date: 13-03-2020

Editor: Laszlo Zsedenyi

About Printing

Lightware Visual Engineering supports green technologies and Eco-friendly mentality. Thus, this document is made for digital usage primarily. If you need to print out few pages for any reason, follow the recommended printing settings:

- Page size: A4
- Output size: Fit to page or Match page size
- Orientation: Landscape

TIPS AND TRICKS: Thanks to the size of the original page, a border around the content (grey on the second picture below) makes possible to organize the pages better. After punching the printed pages, they can be placed easily into a ring folder.

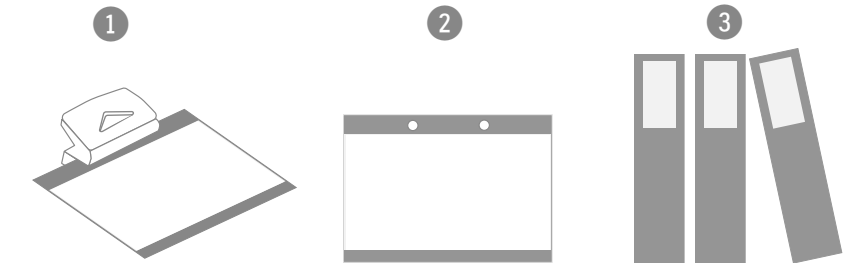

Table of Contents

1. INTRODUCTION	7	4. OPERATION OF MMX6X2-HT FAMILY	21	5.8.5. Creating an EDID.....	37
1.1. DESCRIPTION.....	7	4.1. POWERING ON	21	5.9. CONTROL MENU	37
1.2. COMPATIBLE DEVICES	7	4.2. FRONT PANEL OPERATIONS	21	5.9.1. RS-232 Tab.....	37
1.3. MODEL COMPARISON	7	4.2.1. View Crosspoint State.....	21	5.9.2. Ethernet Tab.....	38
1.4. BOX CONTENTS	7	4.2.2. Switching Operations	22	5.9.3. Infra Tab	38
1.5. FEATURES OF THE DEVICE	8	4.2.3. Output Lock.....	22	5.10. EVENT MANAGER	40
1.6. TYPICAL APPLICATION	8	4.2.4. Control Lock.....	23	5.10.1. The Event Editor.....	40
2. INSTALLATION	9	4.2.5. Save or Load a Preset	23	5.10.2. Create or Modify an Event.....	41
2.1. MOUNTING OPTIONS	9	4.3. FRONT PANEL OPERATIONS – QUICK SUMMARY	24	5.10.3. Special Tools and Accessories.....	41
2.1.1. Standard Rack Installation (Default)	9	4.4. FRONT PANEL LCD MENU OPERATION	25	5.10.4. Clear One or More Event(s).....	42
2.1.2. Mounting with Front and Rear Rack Ears.....	9	4.4.1. Settings Menu.....	25	5.10.5. Export and Import Events	42
2.1.3. Mounting with Mounting Bracket V2.....	9	4.4.2. Network Settings Menu.....	26	5.10.6. Event Creating - Example	42
2.2. CONNECTING STEPS.....	10	4.4.3. Health Status	27	5.11. SETTINGS MENU	43
3. PRODUCT OVERVIEW	11	4.4.4. Inputs Menu	27	5.11.1. Status Tab	43
3.1. FRONT VIEW - ALL MODELS	11	4.4.5. Outputs Menu	27	5.11.2. Network Tab.....	43
3.2. REAR VIEW	12	4.4.6. Signal Info Menu.....	27	5.11.3. System Tab	44
3.2.1. MMX6x2-HT200	12	4.4.7. EDID Settings	28	5.12. CONFIGURATION CLONING (BACKUP TAB)	44
3.2.2. MMX6x2-HT210	12	4.4.8. Device Presets Menu.....	28	5.12.1. Cloning Steps in a Nutshell.....	44
3.2.3. MMX6x2-HT220	12	4.4.9. Info Menu.....	28	5.12.2. Save the Settings of the Device (Backup).....	45
3.3. ELECTRICAL CONNECTIONS	13	5. SOFTWARE CONTROL – LIGHTWARE DEVICE CONTROLLER ...	29	5.12.3. Upload the Settings to a Device (Restore).....	45
3.3.1. HDMI Input and Output Ports	13	5.1. INSTALL AND UPGRADE	29	5.12.4. Create and Restore Backups from the Device Memory	45
3.3.2. Analog Audio Inputs and Outputs	13	5.2. RUNNING THE LDC.....	29	5.13. ADVANCED VIEW WINDOW	46
3.3.3. RS-232 Port.....	13	5.3. ESTABLISHING THE CONNECTION.....	30	6. LW2 PROGRAMMERS' REFERENCE	47
3.3.4. Ethernet (LAN) Port	13	5.4. CROSSPOINT MENU.....	30	6.1. LW2 PROTOCOL DESCRIPTION.....	47
3.3.5. LAN and TPS Ethernet Port.....	13	5.5. PORT PROPERTIES AND SETTINGS	31	6.2. GENERAL LW2 COMMANDS	47
3.4. TPS MATRIX CONCEPT	14	5.5.1. Port Name.....	31	6.2.1. View Product Type.....	47
3.5. TPS INTERFACE.....	14	5.5.2. Mute/Unmute.....	31	6.2.2. View Serial Number	47
3.5.1. TPS Working Modes.....	14	5.5.3. Lock/Unlock.....	31	6.2.3. Query Control Protocol.....	48
3.5.2. Power over Ethernet (PoE).....	14	5.5.4. Autoselect Settings	31	6.2.4. View Firmware Version of the CPU	48
3.6. AUDIO INTERFACE	15	5.5.5. TPS Mode Settings (TPSIN, TPSOUT).....	32	6.2.5. Connection Test.....	48
3.6.1. Audio Inputs and Modes	15	5.5.6. PoE Setting (TPSIN, TPSOUT)	32	6.2.6. Compile Time.....	48
3.7. VIDEO INTERFACE	16	5.5.7. Audio Options	32	6.2.7. View Installed Board(s).....	48
3.7.1. Mirrored Outputs	16	5.5.8. Further Settings (HDMIOUT, TPSOUT)	32	6.2.8. View Firmware for all Controllers'	48
3.7.2. The Autoselect Feature.....	16	5.6. DIAGNOSTIC TOOLS	32	6.2.9. Restart the Matrix Router	48
3.8. CONTROL FEATURES (MATRIX CONTROL AND THIRD-PARTY DEVICES)	17	5.6.1. Cable Diagnostics.....	32	6.2.10. Query Health Status	48
3.8.1. IR Interface.....	18	5.6.2. Frame Detector	33	6.2.11. Restore Factory Default Settings.....	49
3.8.2. Serial Interface.....	19	5.6.3. No Sync Screen (Test Pattern)	33	6.3. PORT AND CROSSPOINT SETTINGS	49
3.8.3. USB Control Interface.....	20	5.7. PRESET SETTINGS	34	6.3.1. Switch One Input to One Output	49
3.9. FURTHER BUILT-IN FEATURES	20	5.8. EDID MENU	35	6.3.2. Mute Specified Output	49
3.9.1. Automatically Launched Actions – the Event Manager.....	20	5.8.1. Sources and Destinations.....	35	6.3.3. Unmute Specified Output.....	49
3.9.2. Matrix Cloning – Backup and Restore the Configuration	20	5.8.2. EDID Operations.....	35	6.3.4. Lock the Output	49
3.9.3. Remote Firmware Upgrade of Connected Lightware Devices.....	20	5.8.3. EDID Summary Window	36	6.3.5. Unlock the Output.....	49
		5.8.4. Editing an EDID	36	6.3.6. View Connection State on the Output.....	49

Table of Contents

6.3.7. View Crosspoint Size.....	50	7.4.3. Query the Video Crosspoint Setting.....	59	7.7.3. Sending a TCP Binary Message (HEX-format) via Ethernet.....	66
6.3.8. Batch Switch Outputs.....	50	7.4.4. Switching Video Input.....	59	7.7.4. Sending a UDP Message (ASCII-format) via Ethernet.....	66
6.3.9. Change the Autoselect Mode.....	50	7.4.5. HDCP Setting (Input Port).....	59	7.7.5. Sending a TCP Text (ASCII-format) via Ethernet.....	67
6.3.10. Change the Video Input Priorities.....	50	7.4.6. HDCP Setting (Output Port).....	59	7.7.6. Sending a UDP Binary Message (HEX-format) via Ethernet.....	67
6.4. NETWORK CONFIGURATION.....	51	7.4.7. Query the Video Autoselect Settings.....	60	7.8. MESSAGE SENDING VIA RS-232 SERIAL PORT.....	67
6.4.1. Query the Current IP Status.....	51	7.4.8. Change the Autoselect Mode.....	60	7.8.1. Sending a Text (ASCII-format) via Serial Port.....	67
6.4.2. Query the IP Address.....	51	7.4.9. Query the Input Port Priority.....	60	7.8.2. Sending a Binary Message (HEX-format) via Serial Port.....	67
6.4.3. Set the IP Address.....	51	7.4.10. Changing the Input Port Priority.....	61	7.8.3. Sending a Message (ASCII-format) via Serial Port.....	67
6.4.4. Query the Subnet Mask.....	51	7.4.11. Mute Input Port.....	61	7.9. INFRARED PORT CONFIGURATION.....	68
6.4.5. Set the Subnet Mask.....	51	7.4.12. Unmute Input Port.....	61	7.9.1. Enable Command Injection Mode.....	68
6.4.6. Query the Gateway Address.....	51	7.4.13. Lock Input Port.....	61	7.9.2. Enable/Disable Output Signal Modulation.....	68
6.4.7. Set the Gateway Address.....	51	7.4.14. Unlock Input Port.....	61	7.9.3. Change Command Injection Port Number.....	68
6.4.8. Query the TCP/IP Port.....	52	7.4.15. Mute Output Port.....	61	7.10. NETWORK CONFIGURATION.....	68
6.4.9. Set the TCP/IP Port.....	52	7.4.16. Unmute Output Port.....	61	7.10.1. Query the DHCP State.....	68
6.4.10. Query the Status of Ethernet Ports.....	52	7.4.17. Lock Output Port.....	62	7.10.2. Change the DHCP State.....	68
6.4.11. Set the Status of Ethernet Ports.....	52	7.4.18. Unlock Input Port.....	62	7.10.3. Query the IP Address.....	69
6.5. LW2 COMMANDS – QUICK SUMMARY.....	53	7.4.19. Test Pattern Generator - Mode.....	62	7.10.4. Change the IP Address (Static).....	69
7. LW3 PROGRAMMERS' REFERENCE.....	54	7.4.20. Test Pattern Generator - Clock Source.....	62	7.10.5. Query the Subnet Mask.....	69
7.1. OVERVIEW.....	54	7.4.21. Test Pattern Generator - Pattern setting.....	62	7.10.6. Change the Subnet Mask (Static).....	69
7.2. PROTOCOL RULES.....	54	7.4.22. Query the Current TPS Mode.....	63	7.10.7. Query the Gateway Address.....	69
7.2.1. LW3 Tree Structure and Command Structure (Examples).....	54	7.4.23. TPS Mode Setting on TPS Ports.....	63	7.10.8. Change the Gateway Address (Static).....	69
7.2.2. General Rules.....	54	7.4.24. HDMI Mode Settings (Output Ports).....	63	7.11. EDID MANAGEMENT.....	69
7.2.3. Command Types.....	55	7.5. AUDIO PORT SETTINGS.....	63	7.11.1. Query the Emulated EDIDs.....	69
7.2.4. Prefix Summary.....	55	7.5.1. Signal Source Selection.....	63	7.11.2. Query the Validity of a Dynamic EDID.....	70
7.2.5. Error Messages.....	55	7.5.2. Analog Audio Input Level Settings - Volume.....	63	7.11.3. Emulating an EDID to an Input Port.....	70
7.2.6. Escaping.....	55	7.5.3. Analog Audio Input Level Settings - Balance.....	63	7.11.4. Copy an EDID to User Memory.....	70
7.2.7. Signature.....	56	7.5.4. Analog Audio Input Level Settings - Gain.....	64	7.11.5. Deleting an EDID to User Memory.....	70
7.2.8. Subscription.....	56	7.5.5. Analog Audio Output Level Settings - Volume.....	64	7.11.6. Resetting the Emulated EDIDs.....	70
7.2.9. Notifications about the Changes of the Properties.....	56	7.5.6. Analog Audio Output Level Settings - Balance.....	64	7.12. LW3 COMMANDS - QUICK SUMMARY.....	71
7.3. SYSTEM COMMANDS.....	57	7.5.7. Analog Audio Output Level Settings - Gain.....	64	8. FIRMWARE UPGRADE.....	74
7.3.1. Querying the Product Name.....	57	7.5.8. Analog Audio Output Level Settings - Mute / Unmute.....	64	8.1. INTRODUCTION.....	74
7.3.2. Set the Device Label.....	57	7.6. RS-232 PORT CONFIGURATION.....	64	8.2. PREPARATION.....	74
7.3.3. Query the Serial Number.....	57	7.6.1. Protocol Setting.....	64	8.2.1. About the Firmware Package (LFP2 File).....	74
7.3.4. Set the Background Light of the LCD Screen.....	57	7.6.2. BAUD Rate Setting.....	65	8.2.2. LDU2 Installation.....	74
7.3.5. Set the Displayed Text on the LCD Screen.....	57	7.6.3. Databits Setting.....	65	8.3. RUNNING THE SOFTWARE.....	75
7.3.6. Identify the Device.....	57	7.6.4. Stopbits Setting.....	65	8.4. THE UPGRADING STEPS.....	76
7.3.7. Resetting the Matrix.....	57	7.6.5. Parity Setting.....	65	8.5. IF THE UPGRADE IS NOT SUCCESSFUL.....	78
7.3.8. Restore the Factory Default Settings.....	57	7.6.6. RS-232 Operation Mode.....	65	9. TROUBLESHOOTING.....	79
7.4. VIDEO PORT AND CROSSPOINT SETTINGS.....	58	7.6.7. Command Injection Mode.....	65	9.1. USE CASE STUDIES.....	79
7.4.1. Query the Status of Source Port.....	58	7.7. MESSAGE SENDING VIA ETHERNET PORT.....	66	9.2. HOW TO SPEED UP THE TROUBLESHOOTING PROCESS.....	81
7.4.2. Query the Status of Destination Port.....	59	7.7.1. Sending a TCP Message (ASCII-format) via Ethernet.....	66		
		7.7.2. Sending a TCP Text (ASCII-format) via Ethernet.....	66		

Table of Contents

10. TECHNOLOGIES	82
10.1. EDID MANAGEMENT	82
10.1.1. Understanding the EDID.....	82
10.1.2. Advanced EDID Management.....	82
10.2. HDCP MANAGEMENT	83
10.2.1. Protected and Unprotected Content.....	83
10.2.2. Disable Unnecessary Encryption.....	83
10.3. PIXEL ACCURATE RECLOCKING	84
11. APPENDIX	85
11.1. SPECIFICATIONS	85
11.2. CABLE WIRING GUIDE	86
11.2.1. Cable Wiring Guide for Serial Data Transmission.....	86
11.2.2. Audio Cable Wiring Guide.....	86
11.3. MECHANICAL DRAWINGS	87
11.4. CONTENT OF THE BACKUP FILE	87
11.5. INPUT AND OUTPUT PORT NUMBERING	88
11.6. MAXIMUM TWISTED PAIR DISTANCES	88
11.7. FACTORY DEFAULT SETTINGS	88
11.8. FACTORY EDID LIST	89
11.9. FURTHER INFORMATION	90

1

Introduction

Thank You for choosing Lightware's MMX6x2-HT200 device. In the first chapter we would like to introduce the device highlighting the most important features in the below listed sections:

- ▶ [DESCRIPTION](#)
- ▶ [COMPATIBLE DEVICES](#)
- ▶ [MODEL COMPARISON](#)
- ▶ [BOX CONTENTS](#)
- ▶ [FEATURES OF THE DEVICE](#)
- ▶ [TYPICAL APPLICATION](#)

1.1. Description

Thank you for choosing Lightware MMX6x2-HT, our HDCP- and HDBaseT™ -compatible HDMI/TPS multiport standalone matrix switcher.

The MMX6x2-HT family responds to a need of a practical standalone matrix switcher specifically designed for meeting room and classroom environments. The flagship of the series is the MMX6x2-HT220 matrix with 6 video inputs and 2 video outputs (4x HDMI 1.4 and 2x TPS inputs and 2x independent video outputs: 2x HDMI ports which are both mirrored to TPS ports). The unit handles 4K video formats and 3D signals while it's fully HDCP compliant. The device has 4 audio input connectors for audio insertion and 2 audio outputs for de-embedding purposes. These features make this standalone matrix unique on the market. Thanks to its integrated PoE power injectors, the MMX6x2-HT is able to remote power TPS (HDBaseT) extenders on all its TPS input and output ports. The matrix receives and transmits digital video, audio, and control up to 170 m distance over a single CATx cable. Using the factory, custom or transparent EDID emulation the user can fix and lock EDID data on each input connector. Advanced EDID Management forces the required resolution from any video source and fixes the output format conforming to the system requirements. The unit offers IR and RS-232 command injection capabilities, allowing to send any IR or RS-232 control command directly from the LAN connection.

Model Denomination

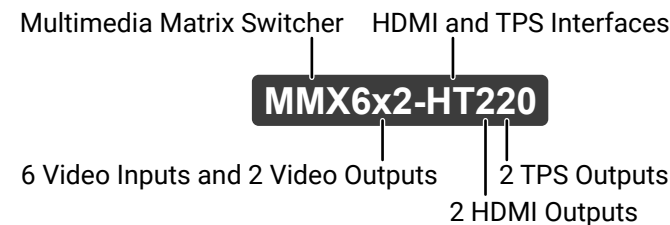

About the Serial Number

Lightware devices contain a label indicating the unique serial number of the product. The structure is the following:

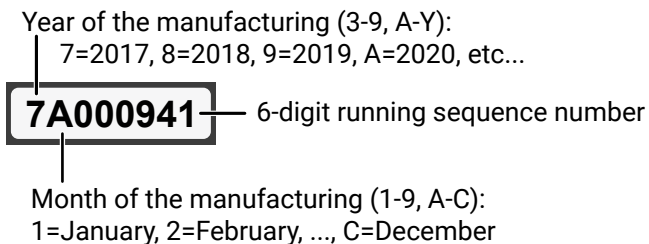

1.2. Compatible Devices

The matrix switchers are compatible with other Lightware TPS devices, matrix boards third-party HDBaseT- extenders, displays, but not compatible with the phased out TPS-90 extenders.

WARNING! The remote power feature of TPS-95 extenders is not PoE-compatible. Thus, TPS-95 series cannot be powered remotely by the MMX6x2 matrix switchers (but the video signal is transmitted to/from the extenders). If an RX95 or TX95 is connected to the matrix, make sure that the remote power jumper of the extender is removed or set to 'Remote power disabled' position.

1.3. Model Comparison

Model	HDMI input	TPS input	Analog audio input	HDMI output	TPS output	Analog audio output
MMX6x2-HT200	4x	2x	4x	2x	-	2x
MMX6x2-HT210	4x	2x	4x	2x	1x	2x
MMX6x2-HT220	4x	2x	4x	2x	2x	2x

1.4. Box Contents

- MMX6x2-HT matrix router
- IEC power cable
- LAN cross cable, CAT5e type, 3 m length
- Phoenix® Combicon 3-pole connector (1 pc)
- Phoenix® Combicon 5-pole connector (6 pcs)
- Safety & Warranty Info, Quick Start Guide

INFO: The matrix is supplied with 2 pcs rack ears which are mounted on the device.

1.5. Features of the Device



3D and 4K Support

High bandwidth allows extension of resolutions up to 4K and even 3D sources and displays are supported.



Signal Transmission up to 170 m

Video and audio signal transmission (DVI, HDMI, Ethernet, RS-232 and Infra-Red over a single CAT5e... CAT7e cable.



HDCP Compliant

MMX6x2-HT family fulfills the HDCP standard. HDCP capability on the digital video inputs can be disabled when non-protected content is extended.



Built-in Event Manager

The Event Manager tool takes care of all the necessary control in a smaller configuration by performing predefined actions in response to device status changes. Hence, in a less complex environment, there is no need to invest in additional control solutions, which makes the MMX6x2-HT series device series the best choice for numerous applications.



Advanced EDID Management

The user can emulate any EDID on the inputs independently, read out and store any attached monitor's EDID in 100 internal memory locations, upload and download EDID files using Lightware Device Controller software.



Pixel Accurate Reclocking

Each output has a clean, jitter free signal, eliminating signal instability and distortion caused by long cables or connector reflections.



Frame Detector and Signal Analysis

The exact video and audio signal format can be determined such as timing, frequencies, scan mode, HDCP encryption, color range, color space and audio sample rate.

1.6. Typical Application

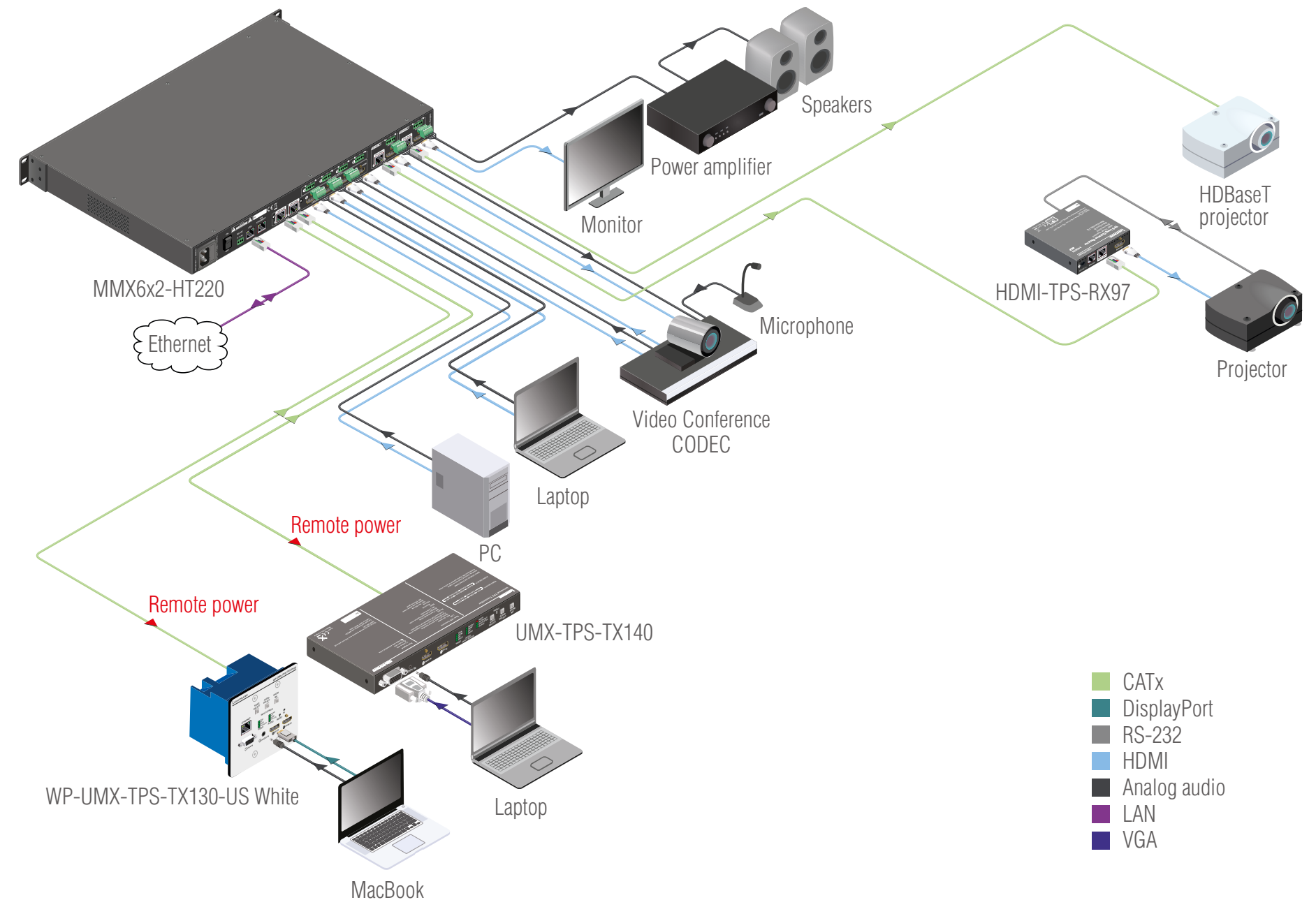

2

Installation

The chapter is about the installation of the device and connecting to other appliances, presenting also the mounting options and further assembly steps:

- ▶ [MOUNTING OPTIONS](#)
- ▶ [CONNECTING STEPS](#)

2.1. Mounting Options

The matrix can be mounted in several ways by the supplied two rack ears. Allen head screws fix them to the housing:

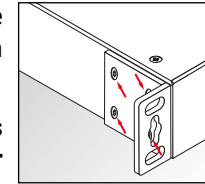

WARNING! Never block the ventilation holes on any side of the matrix! Ensure the proper ventilation by letting the free airflow.

ATTENTION! M4x8 size is the longest allowed screw for fixing the ears to the housing. A longer screw may touch internal parts.

2.1.1. Standard Rack Installation (Default)

Two rack ears are supplied with the product, which are fixed on left and right side as shown in the picture. The default position allows mounting the device as a standard rack unit installation.

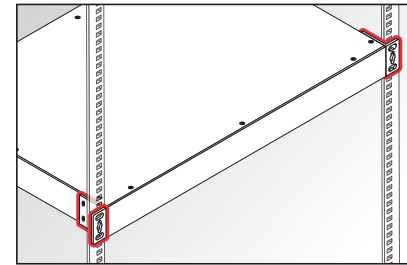

ATTENTION! Always use all the four screws for fixing the rack shelf ears to the rack rail. Choose properly sized screws for mounting. Keep minimum two thread left after the nut screw.

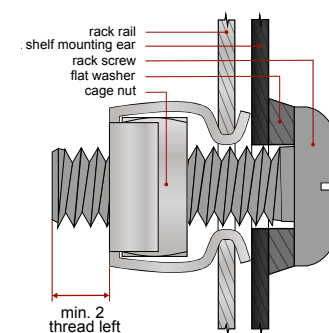

Mounting the device to the rack rail

2.1.2. Mounting with Front and Rear Rack Ears

ATTENTION! Two rack ears are assembled on the matrix as default, thus, you will need two more rack ears for this kind of installation, which can be purchased separately.

The matrix can be easily mounted under the desk by rack ears. This mounting option means the **top of the matrix is parallel with the base surface**.

Please do the following steps:

- Step 1.** Release and remove the fixing screws of the rack ears on the matrix (both sides).
- Step 2.** Rotate the rack ears by 90° to the desired direction.
- Step 3.** Insert the screws into the holes and fix the front ears to the matrix.
- Step 4.** Fix the two additional rear ears (not supplied with the product) by the screws on both sides of the matrix.
- Step 5.** Fix the matrix through the holes of the rack ears to the desired surface (screws are not supplied).

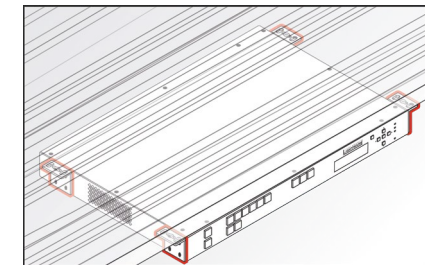

INFO: The method is the same when the matrix has to be mounted to a wall.

2.1.3. Mounting with Mounting Bracket V2

ATTENTION! Two pieces of Mounting bracket V2 will be necessary for this kind of installation which can be purchased separately.



The matrix can be easily mounted under the desk with Mounting bracket V2. This mounting option means that the **front panel of the matrix is parallel with the surface**. Please do the following steps:

- Step 1.** Prepare the desk and cut the necessary hole in the furniture. The frame size is 44.2 × 43.9 mm without rack ears.
- Step 2.** Release and remove the fixing screws of the rack ears on the matrix (both sides) and remove the ears, too.
- Step 3.** Insert the screws into the holes and fix the mounting bracket to the matrix. Pay attention to the thickness of the desk and let enough space to the front when fixing the brackets.
- Step 4.** Insert the matrix in the hole and fix the bracket by the screws to the furniture.

2.2. Connecting Steps

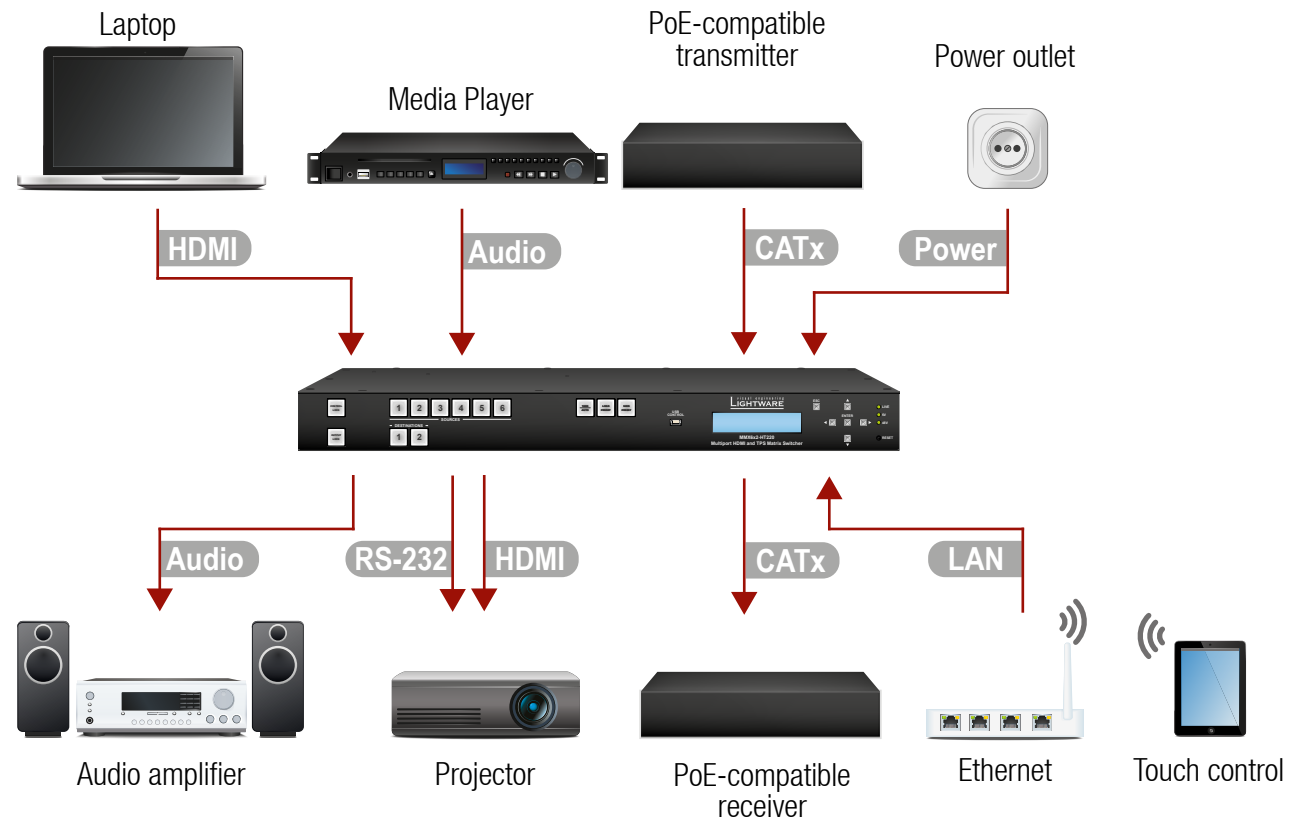

-
- HDMI** Connect the desired sources (e.g. laptop) to the **HDMI input ports**.

 - Audio** Optionally connect an audio source (e.g. media player) to the **Audio input port** which is located above the connected HDMI input port.

 - CATx** Optionally connect the PoE-compatible transmitter to the **TPS input ports**.

 - HDMI** Connect the sink devices (e.g. projector) to the **HDMI output ports**.

 - Audio** Optionally connect an audio device (e.g. audio amplifier) to the **Phoenix Audio output port** which is located above the connected HDMI output port.

 - CATx** Optionally connect the PoE-compatible receiver to the **TPS output ports**.

 - CATx** In order to control the matrix via Ethernet, connect the device to a LAN switch/router, and connect a controller (e.g. a Touch panel).

 - RS-232** Optionally connect the serial device (e.g. projector) to the RS-232 port.

 - Power** Connect the power cord to the AC power socket and to the matrix.

INFO: It is recommended to power on the devices as the final step.

3

Product Overview

The following sections are about the physical structure of the device, input/output ports and connectors:

- ▶ [FRONT VIEW - ALL MODELS](#)
- ▶ [REAR VIEW](#)
- ▶ [ELECTRICAL CONNECTIONS](#)
- ▶ [TPS MATRIX CONCEPT](#)
- ▶ [TPS INTERFACE](#)
- ▶ [AUDIO INTERFACE](#)
- ▶ [VIDEO INTERFACE](#)
- ▶ [CONTROL FEATURES \(MATRIX CONTROL AND THIRD-PARTY DEVICES\)](#)
- ▶ [FURTHER BUILT-IN FEATURES](#)

3.1. Front View - All Models

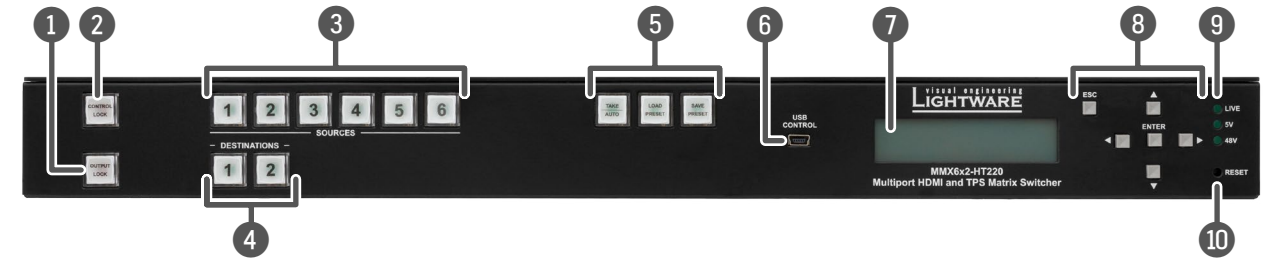

- | | |
|---|---|
| <p>① Control Lock</p> <p>② Output Lock</p> <p>③ Sources</p> <p>④ Destinations</p> <p>⑤ Function Buttons</p> <p>⑥ USB Control</p> <p>⑦ Display</p> <p>⑧ Navigation Buttons</p> <p>⑨ Status LEDs</p> <p>⑩ Reset</p> | <p>Disables or enables front panel operation. When it illuminates red, switching operations on the front panel are prohibited and function buttons are disabled.</p> <p>Locks and protects one (or more) outputs. It inhibits accidental input changing on protected outputs.</p> <p>Source buttons have three functions: to select an input, to select a preset number, and to view the status of the selected input (Take mode).</p> <p>Destination buttons have two functions: to select an output, or to view the selected output's state.</p> <p>Switching between working modes (Take / Autotake), Preset operations are available with the function buttons. See Take / Autotake Mode section for more information.</p> <p>USB mini B-type connection for local control functions (e.g. with Lightware Device Controller software).</p> <p>2x16-character LCD display with backlight for menu operations and settings.</p> <p>(UP, DOWN, LEFT, RIGHT, ENTER, ESCAPE) buttons for menu navigation.</p> <p>Blinking CPU LIVE LED indicates normal operation; DC voltage indicators for internal DC power voltages.</p> <p>Reset button reboots the matrix. This is the same as disconnecting from the power source and reconnecting again.</p> |
|---|---|

INFO: All the three models have the same look and controls on the front panel.

3.2. Rear View

3.2.1. MMX6x2-HT200

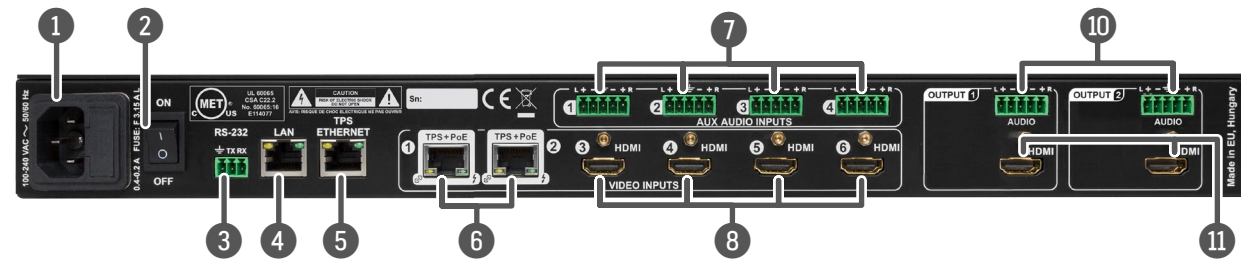

3.2.2. MMX6x2-HT210

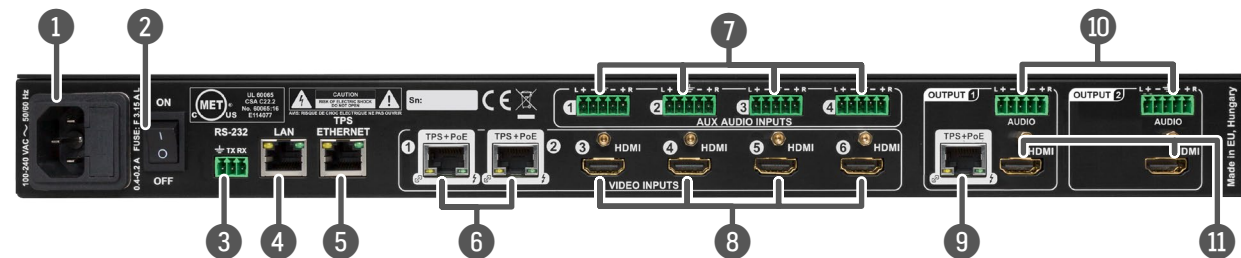

3.2.3. MMX6x2-HT220

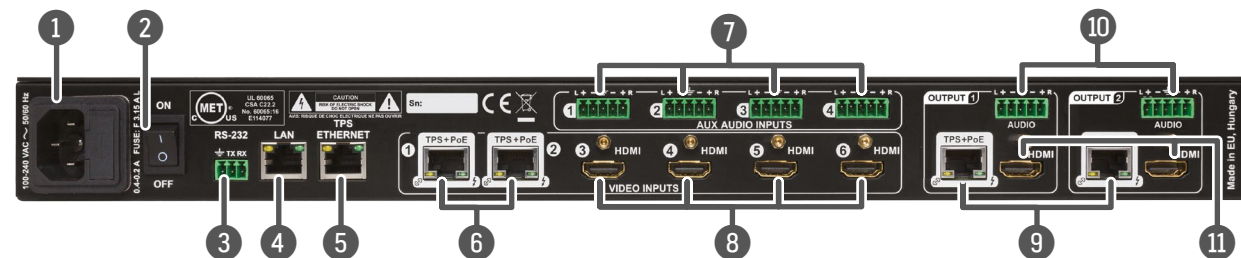

- 1 **AC Connector** Standard IEC power connector. Accepts 100 to 240 Volts, 50 or 60 Hz power sources.
- 2 **On/Off** The matrix can be switched on/off by the power switch.
- 3 **RS-232 Port** 3-pole Phoenix connector for RS-232 serial port. Pin assignment can be found in [RS-232 Port](#) section.
- 4 **LAN** Locking RJ45 connector to control the matrix via LAN/Ethernet – it can be separated from TPS Ethernet communication. Not PoE-compliant. Pin assignment can be found in [Ethernet \(LAN\) Port](#) section.
- 5 **TPS Ethernet** Locking RJ45 connector to supply Ethernet communication for the TPS lines – it can be separated from the LAN communication (controlling functions) of the matrix. Not PoE-compliant. Pin assignment can be found in [LAN and TPS Ethernet Port](#) section.
- 6 **TPS Inputs** Locking RJ45 connector for incoming TPS signal. PoE-compliant. Pin assignment can be found in [LAN and TPS Ethernet Port](#) section.
- 7 **Audio Inputs** 5-pole Phoenix connector for balanced analog audio input. Pin assignment can be found in [Analog Audio Inputs and Outputs](#) section.
- 8 **HDMI Inputs** Connect an HDMI cable between the source and the matrix. Applied cable shall not be more than 20 m (22AWG) when the resolution of the signal is 4K. Pin assignment can be found in [HDMI Input and Output Ports](#) section.
- 9 **TPS Outputs** Locking RJ45 connector for outgoing TPS signal. PoE-compliant. The Audio/Video content on the two given HDMI and TPS output ports are mirrored. Two outputs are available on HT220, one output is available on H210. No TPS output is on HT200. Pin assignment can be found in section [LAN and TPS Ethernet Port](#).
- 10 **Audio Outputs** 5-pole Phoenix connector for balanced analog audio output; the signal is mirrored from the TPS/HDMI output port. Pin assignment can be found in [Analog Audio Inputs and Outputs](#) section.
- 11 **HDMI Outputs** Connect an HDMI cable between the sink and the matrix. HDMI and TPS output ports are mirrored: the same Audio/Video content is switched on the given two ports.

3.3. Electrical Connections

3.3.1. HDMI Input and Output Ports

The matrix switchers are assembled with standard 19-pole HDMI connectors for inputs and outputs.



3.3.2. Analog Audio Inputs and Outputs

5-pole Phoenix connector is used for balanced analog audio (line in/out). Some I/O boards use this connector as a configurable input or output. Unbalanced audio signals can be connected as well. For asymmetrical output, connect only + and ground. For asymmetrical input connect + and ground to the source and connect - to the ground.



Compatible Plug Type

Phoenix® Combicon series (3.5mm pitch), type: MC 1.5/5-ST-3.5.



Pin nr.	Signal
1	Left +
2	Left -
3	Ground
4	Right -
5	Right +

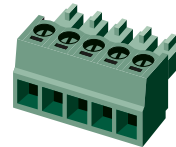

See more information about the most common audio cable wiring modes in [Audio Cable Wiring Guide](#) section.

3.3.3. RS-232 Port

The 3-pole Phoenix connector is used for the local RS-232 serial connection.



Pin nr.	Signal
1	Ground
2	Tx data
3	Rx data

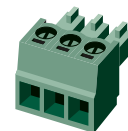

Compatible Plug Type

Phoenix® Combicon series (3.5mm pitch, 3-pole), type: MC 1.5/3-ST-3.5.

See more information about the most common serial data cable wiring modes in [Cable Wiring Guide for Serial Data Transmission](#) section.

3.3.4. Ethernet (LAN) Port

The matrix provides standard RJ45 connectors for TPS input and output ports.

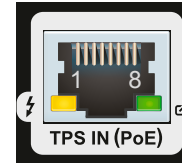
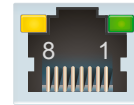

RJ45 connector for LAN port *RJ45 connector for TPS input port*

Wiring of TPS and LAN Cables

Lightware recommends the termination of LAN cables on the basis of TIA/EIA T 568 A or TIA/EIA T 568 B standards.

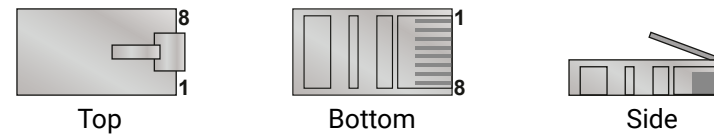

Pin	TIA/EIA T568 A	Color and name	TIA/EIA T568 B	Color and name
1		white/green stripe		white/orange stripe
2		green solid		orange solid
3		white/orange stripe		white/green stripe
4		blue solid		blue solid
5		white/blue stripe		white/blue stripe
6		orange solid		green solid
7		white/brown stripe		white/brown stripe
8		brown solid		brown solid

When a standard Ethernet device is connected to the TPS connector for some reason, the port is switched to Ethernet fallback mode automatically.

3.3.5. LAN and TPS Ethernet Port

The matrix contains two RJ-45 connectors for Ethernet/LAN connection: one for local control functions and one for the TPS lines. The two interfaces are connected (default) but can be separated. The connector with LAN display is for local controlling functions – the matrix can be configured and controlled via local Ethernet via this port. The connector with TPS Ethernet display is to supply the Ethernet to the TPS ports.

The Ethernet ports can be connected to a LAN hub, switch or router by a CATx cable. However both cable types (straight or cross) are supported and handled by the device, below pin assignment is recommended.

Pin	Name	Color and name	
1	TX +		white/green stripe
2	TX -		green solid
3	RX +		white/orange stripe
4	Not used		blue solid
5	Not used		white/blue stripe
6	RX -		orange solid
7	Not used		white/brown stripe
8	Not used		brown solid

	LED1	green		off	0 Mbit/s
				on	100 Mbit/s
	LED2	amber		off	not linked
				on	no activity
				blinking	activity

3.4. TPS Matrix Concept

MMX6x2-HT is the first stand-alone matrix switcher with HDBaseT™ (TPS) technology in Lightware's product range. The matrix gives the possibility to route many kinds of signal formats including TPS and other available interfaces. This chapter is about to present the features and limitations of these interfaces.



Summary of the Interfaces

3.5. TPS Interface

3.5.1. TPS Working Modes

The TPS working mode between the transmitter and the receiver parties is determined by the mode set in them. Both parties influence on the setting which determines the final TPS transmission mode.

The following TPS modes are defined in the matrix:

- **Auto:** The TPS mode is determined automatically.
- **HDBaseT:** Ideal for high resolution signals up to 4K but with a shorter cable.
- **Long reach:** Ideal for big distances up to 1080p@60Hz.
- **LPPF1*:** Only RS-232 communication is transmitted (@ 9600 baud)
- **LPPF2*:** Only RS-232 (@ 9600 baud) and Ethernet communication are transmitted.

* LPPF: Low Power Partial Functionality

Above settings refer to the matrix. The table below details the system's state with regard to mode selection behavior for all possible combinations for both ends of the link:

		Selected mode on RX side				
		LPPF1	LPPF2	HDBaseT	Long reach	Auto
Selected mode on TX side	LPPF1	LPPF1	LPPF1	LPPF1	LPPF1	LPPF1
	LPPF2	LPPF1	LPPF2	LPPF2	LPPF2	LPPF2
	HDBaseT	LPPF1	LPPF2	HDBaseT	Long reach	HDBaseT
	Long reach	LPPF1	LPPF2	Long reach	Long reach	Long reach
	Auto	LPPF1	LPPF2	HDBaseT	Long reach	HDBaseT **

** If there is valid HDMI/DVI signal is on the TX side, the TPS mode will be HDBaseT on both side. If the transmitter does not transmits HDMI/DVI signal, the TPS mode will be changed to LPPF2 automatically. Long reach mode is not available when both sides are set to Auto mode.

When using automatic operation mode selection, the device uses built-in sensors to determine the mode of operation. If both parties are set to Auto mode, the source side is the initiator. It will negotiate each state transition with its sink side partner.

When one of the devices is configured to manual operation mode selection, the other device may be placed in automatic mode. In this case, the mode transition negotiation is initiated by the host-managed device and the auto-mode device follows through. The allowed cable lengths and resolutions are listed in [Maximum Twisted Pair Distances](#) section.

3.5.2. Power over Ethernet (PoE)

TPS input and output ports are able to supply other HDBase-T compliant devices over the TPS lines which are PoE-compliant as well. In this case, the connected transmitter or receiver does not require a local power supply.

ATTENTION! The Ethernet ports do not support PoE. Only the TPS ports support PoE function.

WARNING! The remote power feature of TPS 95 series extenders is not PoE-compatible. Thus, TPS 95 series cannot be powered remotely by the MMX6x2 matrix switchers (but the video signal is transmitted to/from the extenders). If a TPS 95 extender is connected to the matrix, make sure that the remote power jumper of the extender is removed or set to 'Remote power disabled' position.

The PoE feature in the practice

The TPS ports of the matrix are in accordance with IEEE 802.3af (PoE) standard. The feature is demonstrated on below figure:

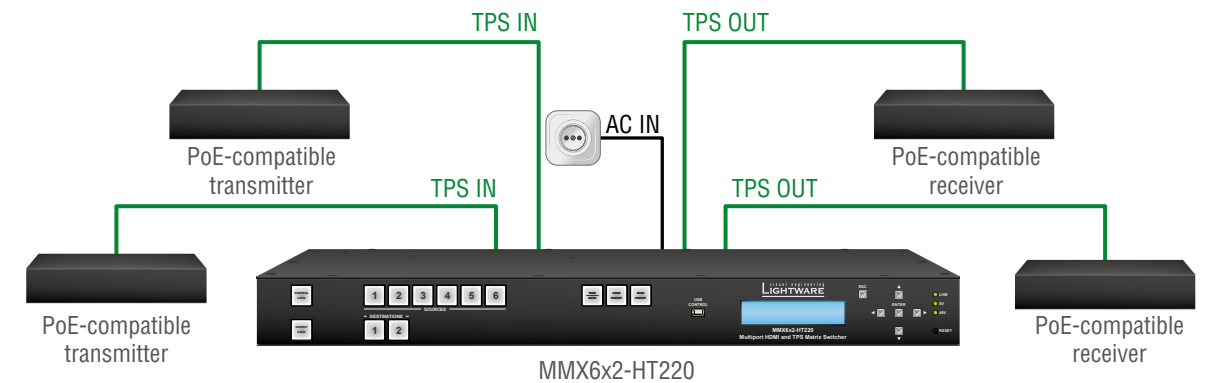

Extenders Supplied without Local Power

The concept

Supply the connected extenders through the CATx (TPS) cables without local adapters.

Settings

- **Extenders:** the device must be PoE-compatible or else the feature will not work.
- **Matrix:** make sure the PoE option on the TPS port is enabled (which is the default setting) via LDC in the port properties window; see [Preset Settings](#) section.

INFO: PoE-compatible and not compatible devices can be connected simultaneously as the feature can be set individually on each port.

3.6. Audio Interface

3.6.1. Audio Inputs and Modes

The matrix can receive audio from two type of sources:

- Embedded (4x HDMI and 2x HDBaseT in) and
- Analog balanced stereo audio sources (4x).

The audio coming from the analog inputs can be assigned to any video input or output. The volume/gain levels of the analog audio input/output ports are adjustable.

Input audio modes

ATTENTION! Input audio modes are valid if the output audio mode is set to Pass-through mode.

- Embedded: The original audio of the HDMI signal is embedded in the video stream.
- AUX1...AUX4: Auxiliary audio is embedded in the video stream.

Output audio modes

ATTENTION! The output audio modes can override the input audio mode when it is Aux1...Aux4.

- Pass-through: This mode allows the input to set the audio source.
- AUX1...AUX4: In this mode Aux1...Aux4 is locked to the output. The input cannot modify this audio source. Always this source will be selected.
- Copy from other output: the same audio as present on the other output.

Audio options – example

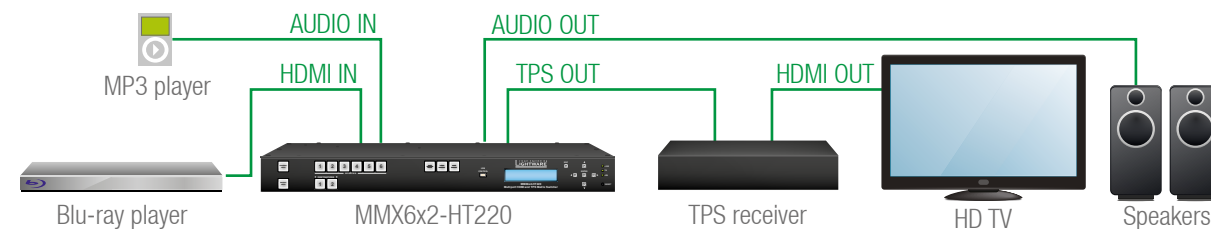

Audio selection

The concept

The same audio is present on the TPS and Audio outputs. The desired source can be switched to the outputs: the MP3 player or the Blu-ray player. In both cases, the video signal is coming from the Blu-ray player.

Settings (matrix)

If the HDMI audio (Blu-ray) is switched to the outputs:

- **HDMI input** properties: Signal source set to Embedded.
- **HDMI output** properties: Signal source set to Pass-through.

If the Mp3 player is switched to the outputs:

- **HDMI input** properties: Signal source set to AUXn.
- **HDMI output** properties: Signal source set to Pass-through or AUXn.

See the settings in [Audio Options](#) section.

INFO: The input audio modes are valid if the output audio mode is set to Pass-through mode.

3.7. Video Interface

The video crosspoint settings can be controlled by any of the following ways:

- Pressing the Source and Destination buttons on the front panel,
- Using Lightware Device Controller,
- Sending LW2 or LW3 protocol command, or
- Using the Autoselect function.

3.7.1. Mirrored Outputs

The matrix has 4 HDMI and 2 HDBaseT input ports. One or two input ports can be routed to the output ports at the same time. Optionally each TPS output port can have a mirrored HDMI output port which means the same video stream is transmitted over the HDMI output port and the TPS output port. Three variants are available, the difference between the versions is the number of the mirrored output ports:

- **MMX6x2-HT200:** 2x HDMI out
- **MMX6x2-HT210:** 2x HDMI out, 1x TPS out (HDMI out1 mirrored)
- **MMX6x2-HT220:** 2x HDMI out, 2x TPS out (HDMI out1 and out2 mirrored)

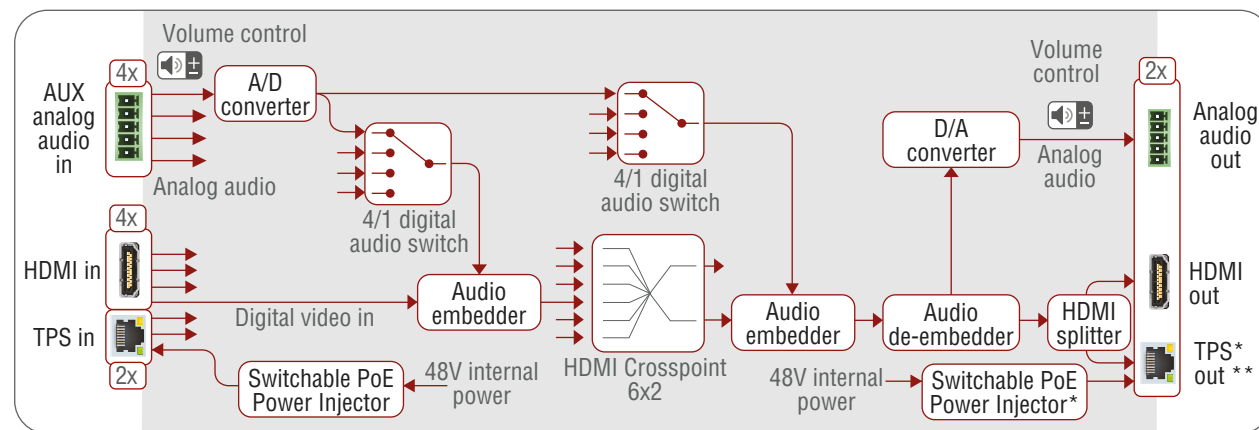

MMX6x2-HT port diagram

* Not available on MMX6x2-HT200.

** Available on output 1 on MMX6x2-HT210 and on output 1 & 2 on MMX6x2-HT220.

3.7.2. The Autoselect Feature

There are three types of Autoselect as follows:

First detect mode: Selected input port is kept connected to the output while it has an active signal.

Priority detect mode: Always the highest priority active input is selected to transmit.

Last detect mode: Always the last attached input is selected to transmit.

INFO: The input ports, where the priority is set to 31 will not be scanned. See more details about this setting in [Query the Input Port Priority](#) section.

INFO: An input port is active if there is a valid signal on it.

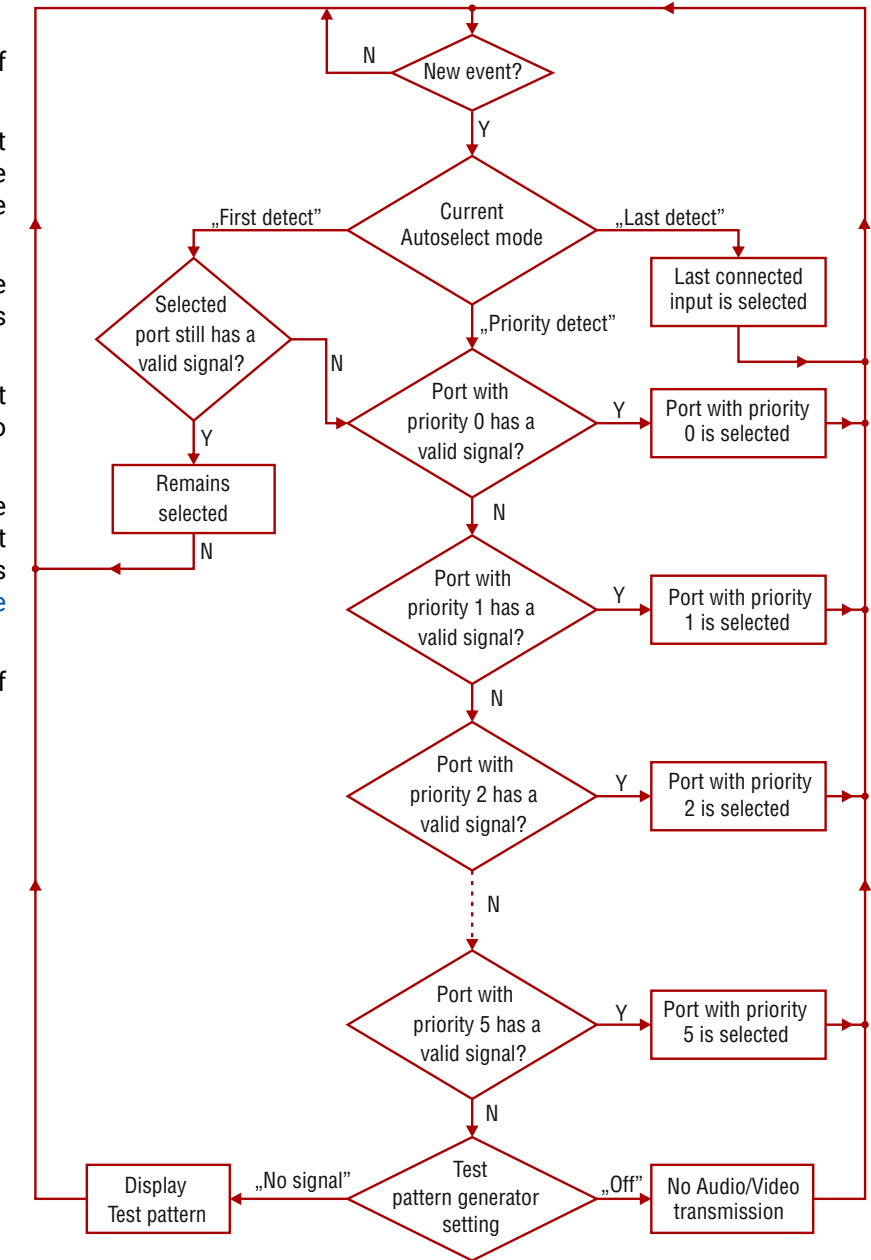

Flowchart of the Autoselect modes

Input selection automatically – example

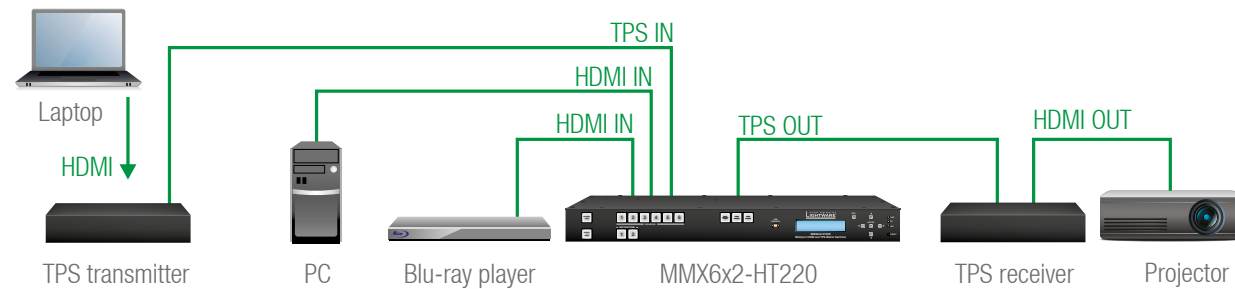

The concept

If a video signal of the Blu-ray player is present on the HDMI input of the matrix, the source will be automatically switched to the TPS output. If the video signal of the PC is also present on the other HDMI input of the matrix, it will be switched to the TPS output. If the Laptop is connected, the TPS input will be switched to the TPS output – independently of the presence of the other video signals.

Settings

TPS output: Set the Autoselect to **Enabled**. The Autoselect mode is **Priority detect**. The priorities are the followings:

	Port	Priority
Laptop	(I1, TPS IN)	0
PC	(I3, HDMI IN)	1
Blu-ray	(I4, HDMI IN)	2

The other inputs can be disabled. See the settings in [Autoselect Settings](#) section.

3.8. Control Features (Matrix Control and Third-Party Devices)

The interfaces of the MMX6x2-HT can be used to install the matrix at any place of a complex A/V system. Besides, the matrix is able to handle controlling functions as well. This chapter is about to present the possibilities through three simple layout examples.

System control via local Ethernet (example)

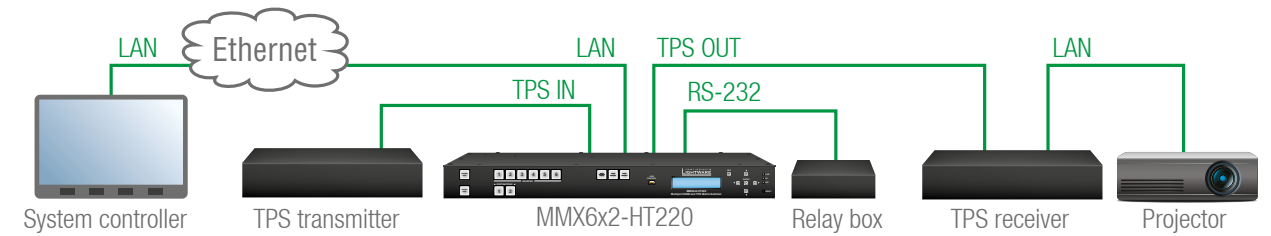

The following ways are available for controlling the devices:

- The **System controller** can communicate with LW2/LW3 protocol commands via the local IP:port address of the **Matrix**, see the settings in [Factory Default Settings](#) section).
- The **System controller** can communicate directly with the **Projector** or an **Extender** via their IP:port address.
- The **System controller** can communicate directly with the RS-232 **relay box** connected to the **Matrix**. In this case, **Command Injection mode** has to be enabled on the local RS-232 port.
- The **matrix** can send a command (e.g. as an action by the Event Manager) to the IP:port address of the **Projector** or an **Extender** by using LW3 protocol methods; for details see the [Infrared Port Configuration](#) section.

System control via local RS-232 (example)

The following ways are available for controlling the devices:

- The **System controller** can communicate with LW2/LW3 protocol commands via the local RS-232 port of the **Matrix** (see the default RS-232 port settings in [Factory Default Settings](#) section).
- The **System controller** can send TCP or UDP messages to the IP:port address of the **Matrix** or the **Extender**, by using LW3 protocol methods, see [Infrared Port Configuration](#) section.
- The **Matrix** can send TCP or UDP messages command to the **HDTV** or the **Extender** by using LW3 protocol methods, see [Infrared Port Configuration](#) section.

System control via extended Ethernet (example)

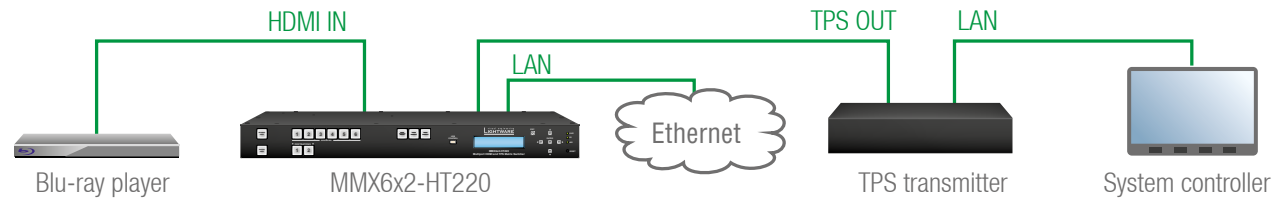

Current setup allows the following:

- The **System controller** can communicate with LW2/LW3 commands to the IP:port address of the **Matrix** or the **Extender**.

3.8.1. IR Interface

Technical background

The Infrared signal transmission is similar to the serial data communication. However the matrix does not contain dedicated IR I/O connection, the TPS interface can transmit/receive IR signal in pronto HEX format.

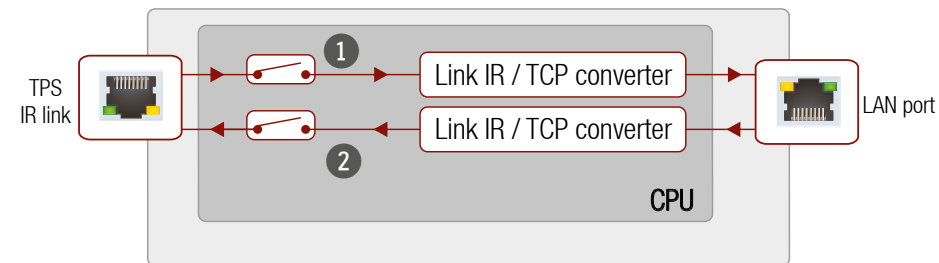

IR interface block diagram

- IR input of the TPS port.
- IR output of the TPS port.

When the data transmission is enabled, the input/output port works in Command injection mode. The IR data (in pronto HEX format) is transferred between the TPS port and the LAN port. Separate user-configurable TCP/IP port numbers are defined for TPS IR input and IR output ports for this purpose, see [Factory Default Settings](#) section. The settings are available in the LDC software, see [Infra Tab](#) section.

ATTENTION! The IR signal cannot be routed from an IR port to another IR port.

IR signal transmission – example

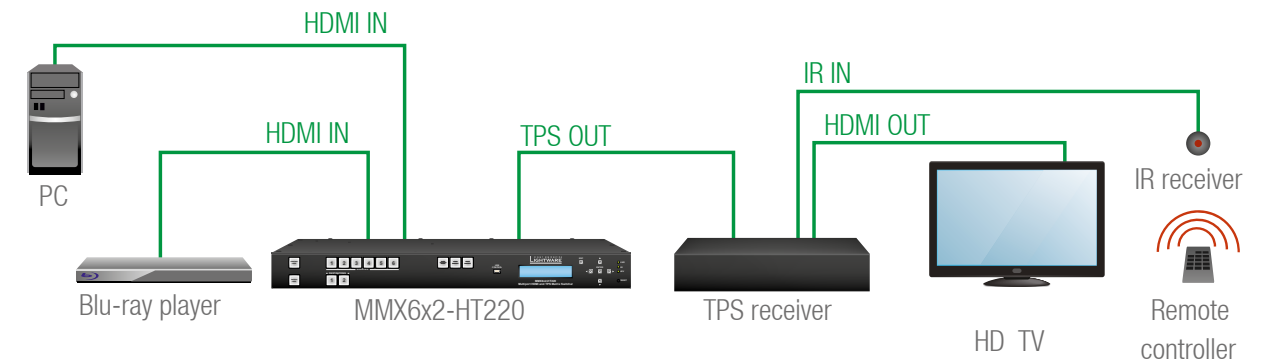

IR Signal Transmission

The concept

When a certain button is pressed on the remote controller, the crosspoint is changed in the matrix. The IR code is sent through the TPS cable and recognized by the matrix. The recognized code is a condition which triggers the action (crosspoint change).

Settings

Matrix: The matrix has to learn the IR code in advance to recognize it, see [Infra Tab](#) section. Then create a new event, where the stored IR (hash) code is the condition, see [Create or Modify an Event](#) section. The action is the desired crosspoint setting.

3.8.2. Serial Interface

Technical background

Serial data communication can be established via the local RS-232 port (Phoenix connector) or via the TPS lines. The RS-232 ports – which are connected to the microcontroller – can be configured separately (e.g. if the Baud rates are different, the microcontroller does the conversion automatically between the ports). The RS-232 port can be switched to **Control mode**, **Command Injection mode**, or can be **Disconnected**; see the figure below.

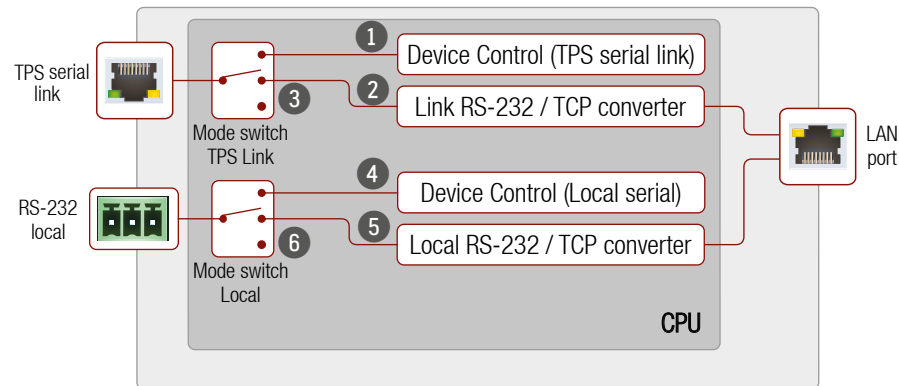

The block diagram of the Serial interface

All settings are available in the LDC software, see [RS-232 Tab](#) section.

The following settings are defined:

- 1 The TPS serial link port is in **Control mode**.
- 2 The TPS serial link port is in **Command Injection mode**.
- 3 The TPS serial link port is **Disconnected**.
- 4 The Local serial port is in **Control mode**.
- 5 The Local serial port is in **Command Injection mode**.
- 6 The Local serial port is **Disconnected**.

Control mode 1 4

The incoming data from the given port is processed and interpreted by the Microcontroller. The mode allows to control the matrix directly. LW2 or LW3 protocol commands are accepted – depending on the current port setting.

Command injection mode 2 5

In this mode, the matrix works as an RS-232–Ethernet bidirectional converter. The Ethernet packets are converted to RS-232 data and vice versa. Unique TCP/IP port numbers are defined for the serial ports (TPS and local) for this purpose. E.g. the default Command Injection port number of the local RS 232 port is 8001. If a command is coming from the LAN interface which is address to the port no. 8001, it will be transmitted

to the Tx pin of the local RS-232 port. That works in the opposite direction of course and the method is the same on the serial interface of the TPS ports. See the RS 232 settings in [Factory Default Settings](#) section.

ATTENTION! The serial data cannot be routed from an RS-232 port to another RS-232 port.

RS-232 signal transmission – example

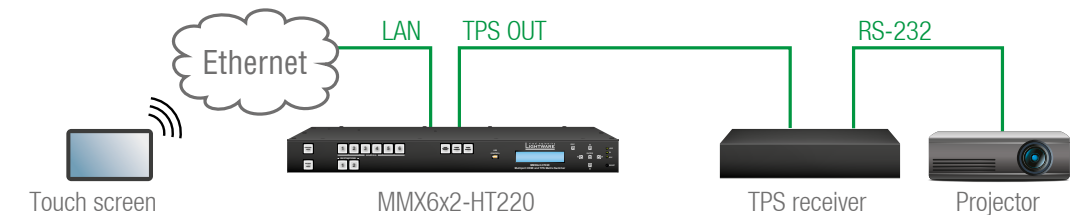

RS-232 signal transmission

The concept

The Touch controller can send commands (input/output switching, control functions, etc.) to the matrix and is able to remote control the projector via RS-232.

Settings

- **Touch controller:** wireless IP connection to the same Ethernet as the matrix is connected to. Use a dedicated software tool (e.g. a terminal) which is suitable for sending commands via TCP/IP to a certain IP:port address.
- **Matrix:** The RS-232 interface of the TPS OUTPUT 1 (P4) is in Command Injection (CI) mode. Set the further parameters (Baud rate, Data bits, etc.) in accordance with the specifications of the projector. See [RS-232 Tab](#) section.
- **Receiver:** set the RS-232 switch to Normal position. The receiver will transmit the RS 232 data between the TPS input port and the RS-232 port.
- **Projector:** note the RS-232 port setting that is specified by the Manufacturer. Connect a suitable serial cable with the proper wiring.

Command sending

- You can send LW3 protocol commands to the **192.168.0.100:6107** port to control the matrix.
- You can send LW2 protocol commands to the **192.168.0.100:10001** port to control the matrix.
- You can send commands to the **192.168.0.100:8004** port to control the projector. This port number means the RS-232 interface of the TPS output port (TPS O1).

INFO: Above values are examples and based on factory default settings.

3.8.3. USB Control Interface

The device can be controlled over front panel USB mini B-type connector. This interface only supports LW3 protocol. The interface can be used to establish a connection to Lightware Device Controller software.

3.9. Further Built-in Features

3.9.1. Automatically Launched Actions – the Event Manager

The Event manager feature means that the device can sense changes on its ports and is able to react according to the pre-defined settings. Lightware Device Controller contains a user-friendly software tool and allows to create Events by defining a Condition and an Action.

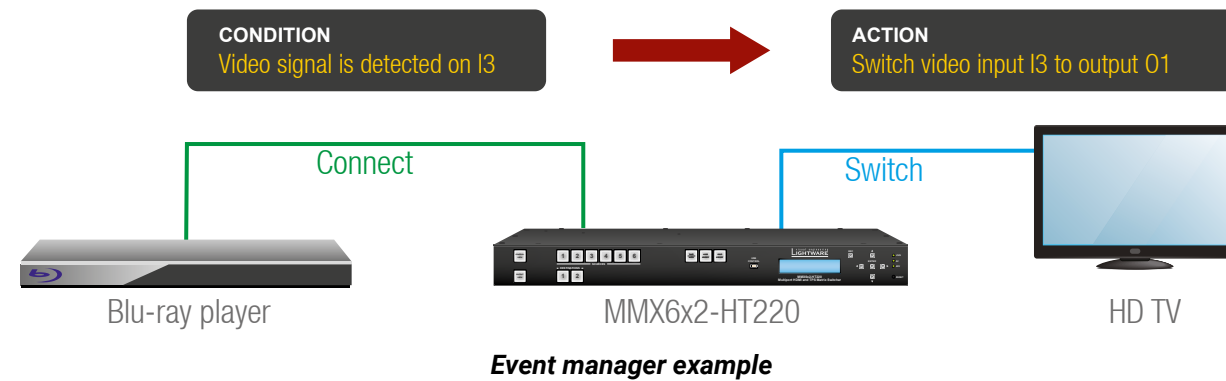

See more information about the settings in [Event Manager](#) section.

3.9.2. Matrix Cloning – Backup and Restore the Configuration

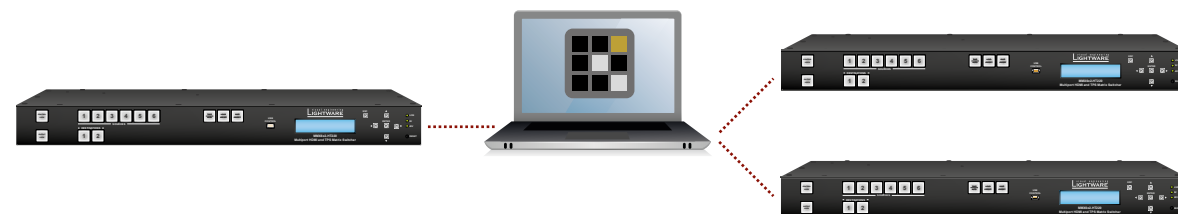

The matrix (configuration) cloning of MMX6x2-HT devices is a simple method that eliminates the need to repeatedly configure certain devices to have identical (non-factory) settings. If the devices are installed in the same type of system multiple times then it is enough to set up only one device to fit the user's needs and then copy those settings to the others, thus saving time and resources.

See the details of the process in [Configuration Cloning \(Backup Tab\)](#) section

3.9.3. Remote Firmware Upgrade of Connected Lightware Devices



The firmware of the Lightware TPS devices can be upgraded individually by Lightware Device Updater (LDU) software. MMX6x2 HT series contains a new feature which allows having a faster and more comfortable firmware upgrade process. When the firmware of the connected extenders has to be upgraded the TPS connection is necessary towards the extenders – nothing else. The LDU will find the connected devices and can upgrade them.

The upgrade process is almost the same as in the case of the usual upgrade process.

ATTENTION! The feature is supported by firmware v1.1.0 or above.

4

Operation of MMX6x2-HT Family

This chapter is about the powering and operating of the device describing the functions which are available by the front/rear controls:

- ▶ [POWERING ON](#)
- ▶ [FRONT PANEL OPERATIONS](#)
- ▶ [FRONT PANEL OPERATIONS – QUICK SUMMARY](#)
- ▶ [FRONT PANEL LCD MENU OPERATION](#)

4.1. Powering on

Connect the power cord to the IEC standard power input connector. Switch on the matrix by the power switch on the rear panel.

During the initial self-test and loading of the latest settings 'Booting...' appears on the LCD screen. After the self-test, the router reloads its last configuration and it is ready to use. In the case of hardware failure, an error message is displayed.

ATTENTION! After switching ON, the router reloads the latest settings that were used before it was turned off. The router has an internal emergency memory that stores all current settings and tie configurations. This memory is independent of presets and invisible for the user. This built-in feature helps the system to be ready immediately in case of power failure or accidental power down.

4.2. Front Panel Operations

Control Lock

When **Control lock** button illuminated red, the device is in control locked mode, that means front panel operations are disabled. Front panel operations are enabled if **Control lock** button is not lit.

Press and hold the **Control lock** button for three seconds to toggle control lock state. Front panel button operations can be enabled or disabled using Control lock button while remote control (RS-232, USB or Ethernet) is still available.

Take / Autotake Mode

The router has two different switching modes: **Take** and **Autotake**. If the **Take** button is unlit, **Take** mode is active. When the **Take** button continuously illuminates green, **Autotake** mode is selected. Press and hold the **Take** button for two seconds to change between **Take** and **Autotake** modes.

Take mode allows the user to connect or disconnect multiple outputs to an input at once. This mode is useful when the time delay is not allowed between multiple switching. The commands are only realized when the **Take** button is pressed.

ATTENTION! If no button is pressed for three seconds, all preselected actions (which were not realized with the pressing TAKE) will be ignored, and the router returns to its idle state.

Autotake mode is useful when immediate actions must be done or fast switching is needed between sources on a particular destination. In this mode switching occurs immediately upon pressing one of the input selector buttons.

4.2.1. View Crosspoint State

The current switching status can be checked on the front panel by using the front panel buttons. The crosspoint state is displayed slightly different in **Take** or **Autotake** modes because of the different switching methods.

INFO: View mode does not mean, that the router has to be switched in different modes, viewing and switching can be done after each other, without pressing any special buttons.

View Current State in Take Mode

If the router is in **Take** mode, the user can verify both input and output connections. In **Take** mode no accidental change can be done unless **Take** button is pressed.

Press and release a **source button**. Now the selected source button and all destination buttons which are currently connected to the selected source will light up. This informative display will remain active for three seconds, then all buttons turn to dark.

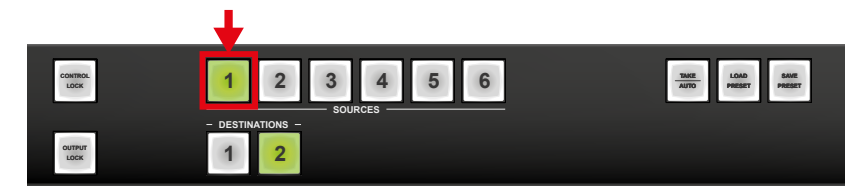

Sample drawing shows that Input 1 is currently connected to the Output 2 port.

If every source, destination, and **Take** buttons are unlit (the unit is in **Take** mode, and no input was selected in the last 3 seconds), press and release a **destination button** to see its current state. Now the source button, which is connected to the selected destination, will light up.



Sample drawing shows that Output 2 is connected to the Input 1.

View Current State in Autotake Mode

In **Autotake** mode only states of destinations can be viewed.

Press and release the required **destination button**. Now the source button, which is connected to the selected destination, will light up.



4.2.2. Switching Operations

Switching in Take Mode



Take mode allows the user to connect or disconnect multiple outputs to an input at once. This mode is useful when the time delay is not allowed between multiple switching. The commands are only realized when the **Take** button is pressed.

Step 1. First, press and release the desired **source button**. The pressed source button and all destination buttons which are currently connected to the source lights up.



Step 2. Press and release the desired **destination buttons** which have to be (dis)connected to/from the selected source. The preselected destination buttons will blink. If no button is pressed for three seconds, the buttons will turn to dark.



Step 3. Press and release **Take** button; the selected input is switched to the selected output(s).



Switching in Autotake Mode



Autotake mode is useful when immediate actions must be done or fast switching is needed between sources on a particular destination. In this mode switching occurs immediately upon pressing one of the input selector buttons.

Step 1. Press and release the desired **destination button**. The pressed destination button and the actually connected source button light up green. If no source is connected (the output is muted) no source button will light up.



Step 2. Press and release the desired **source button**. The switch action will be executed immediately. Switching between sources to the selected destination can be done directly.



4.2.3. Output Lock

ATTENTION! However, the front panel buttons allow to lock only the output ports, the input ports can also be locked by using Lightware Device Controller software (see [Video Port and Crosspoint Settings](#) section) or sending LW3 protocol command (see [Lock Input Port](#) section).



Using Lightware routers it is possible to lock a destination. This feature prevents an accidental switching to the locked destination in case of an important signal. Locking a destination means that no input selection or muting action can be executed on that particular destination.

Destinations can be independently locked or unlocked. Locking a destination does not affect other destinations.

Output Lock in Take Mode

Step 1. Press and release the **Output Lock** button; it starts to blink and all the buttons of any locked destinations light up (view state).



Step 2. Press and release a **destination button**; it starts to blink (more destinations can be selected sequentially).



Step 3. Press and release **Take** button. The selected destinations are now locked.



Output Lock in Autotake Mode

Step 1. Press and release the required **destination button**. Now the selected destination button and the currently configured source button light up (view mode).



Step 2. Press and release the **Output Lock** button; it lights up in red, and lock function is activated at once. No source can be changed at the locked destination.



4.2.4. Control Lock



Front panel button operation can be enabled or disabled using **Control Lock** button, while the remote control is still enabled. If the button is unlit, front panel button operation is enabled. If the button is continuously illuminated in red the front panel operations are not possible. Press and keep the **Control Lock** button pressed for three seconds to toggle between the control lock states.

4.2.5. Save or Load a Preset



The matrix can store user-programmable presets. Each preset stores a configuration regarding all input connections for all outputs. All presets are stored in a non-volatile memory; the router keeps the presets even in the case of a power down. Please note, that preset operations can be followed on the LCD during front panel preset operations.

ATTENTION! Eight of the memory slots are available by the Source buttons; see [Preset Settings](#) for the details.

Saving a Preset in Take Mode

Step 1. Press and release **Save Preset** button.



Step 2. Press and release the desired **source (memory address) button** (source 1 to 6).



Step 3. Press and release the **Take** button. Now the current configuration is stored in the selected memory.



ATTENTION! Preset save action always stores the current configuration for all outputs.

Loading a Preset in Take Mode

Step 1. Press and release the **Load preset** button.



Step 2. Press and release the desired **source (memory address) button** (source 1 to 6).



Step 3. Press and release the **Take** button. Now the selected preset is loaded.



Saving a Preset in Autotake Mode

Step 1. Press and release the **Save Preset** button.



Step 2. Press and release the desired **source (memory address) button** (source 1 to 6). Now the current configuration is stored in the selected memory.



ATTENTION! Preset save action always stores the current configuration for all outputs.

Loading a Preset in Autotake Mode

Step 1. Press and release **Load Preset** button.



Step 2. Press and release the desired **source (memory address) button** (source 1 to 6). Now the selected preset is loaded.



4.3. Front Panel Operations – Quick Summary

Take mode

View input connections



View output connections



Change connections

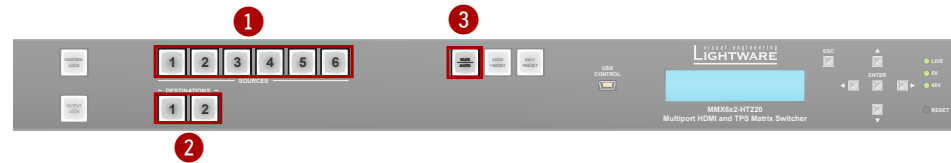

Save a preset



Load a preset



View locked outputs



Lock/unlock an output

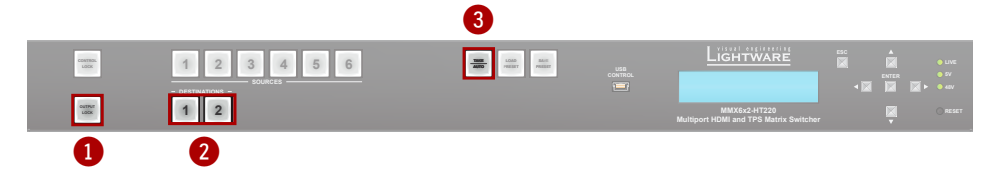

Autotake mode

View current state



Create a connection

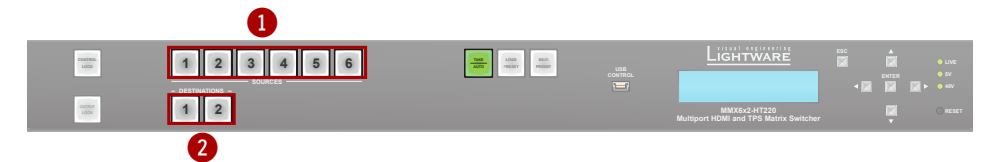

Save a preset



Load a preset



View locked state of an output



Lock/unlock an output



4.4. Front Panel LCD Menu Operation

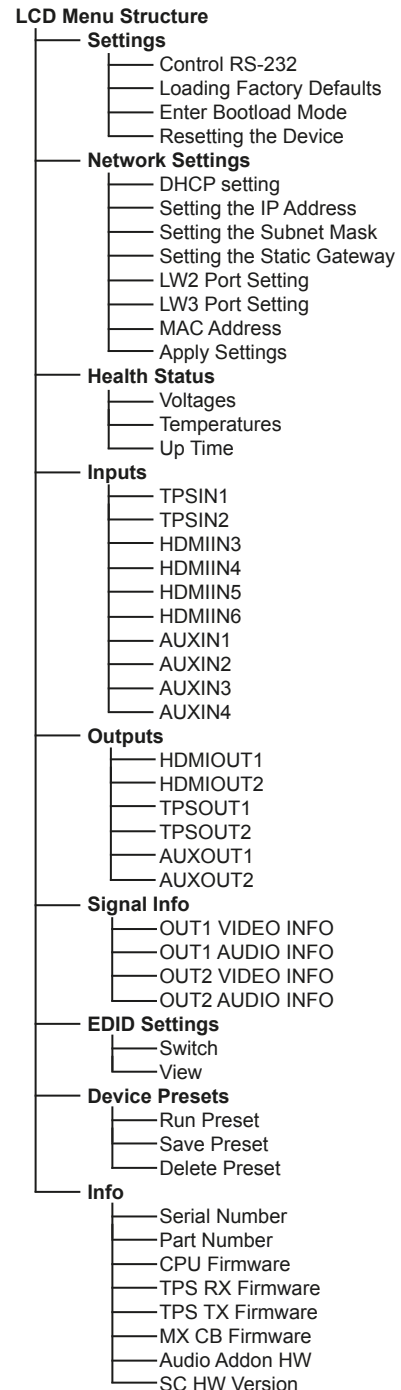

The matrix has an LCD menu and navigation buttons which make the possibility to change certain settings and display basic information via the front panel.

Navigation

Front panel LCD has 2 lines and 16 characters in each line. The name of the menu item is always displayed in the first line. If no button is pressed for 5 minutes, LCD returns to its idle state and Device information is shown.

Buttons	Functions
▲ up	Toggle between menu items
▼ down	
◀ left	Move the cursor or step back to the previous menu
▶ right	Move the cursor
◆ enter	Execute changes or enter submenu
• escape	Step back to the previous menu; cancel the operation

Display mode / Edit mode

The parameters are displayed in two modes on the LCD as follows:



In **Display mode**, the value cannot be changed; the ▲ up and ▼ down buttons can be used to step between the submenu items (e.g. IP address – Subnet mask – Static gateway, etc.). In **Edit mode**, the values can be changed with the ▲ up and ▼ down buttons.

Display mode is the default; select the desired parameter and press ◆ enter to select **Edit mode**.

Idle state (Device information)

If no button is pressed for 5 minutes or the user navigates out from the menu by the escape • and/or the left ◀ button, LCD gets into idle state. Front panel menu displays the following information in idle state:

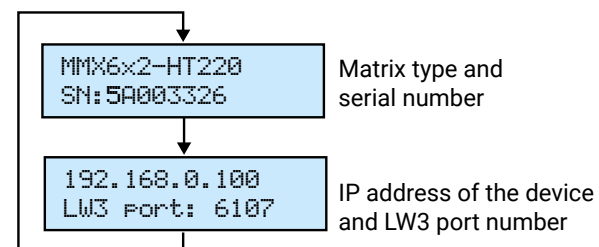

4.4.1. Settings Menu

Control RS-232 settings

The local RS-232 port settings are available in the front panel menu.

Baud rate

Step 1. Navigate to Settings / Control RS232 / Baudrate submenu and press the enter ◆ button.

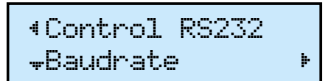

Step 2. To change the setting, press the enter ◆ button and use the up ▲ and down ▼ buttons to select the desired value.

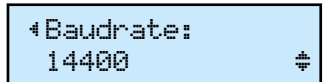

Step 3. Press the enter ◆ button to save changes.

Data Bits

Step 1. Navigate to Settings / Control RS232 / Data Bits submenu and press the enter ◆ button.

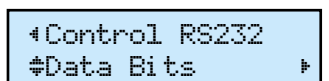

Step 2. To change the setting, press the enter ◆ button and use the up ▲ and down ▼ buttons to select the desired value.

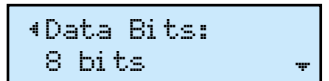

Step 3. Press the enter ◆ button to save changes.

Stop Bits

Step 1. Navigate to Settings / Control RS232 / Stop Bits submenu and press the enter ◆ button.

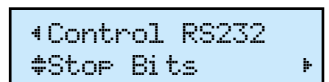

Step 2. To change the setting, press the enter ◆ button and use the up ▲ and down ▼ buttons to select the desired value.

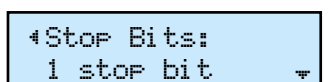

Step 3. Press the enter ◆ button to save changes.

Parity

Step 1. Navigate to Settings / Control RS232 / Parity submenu and press the enter ◆ button.

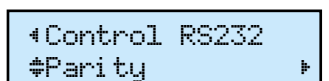

Step 2. To change the setting, press the enter ◆ button and use the up ▲ and down ▼ buttons to select the desired setting.

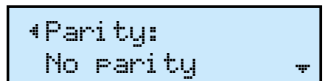

Step 3. Press the enter ◆ button to save changes.

Loading factory default settings

Step 1. Navigate to Settings / Fact. defaults submenu and press the enter ◆ button.

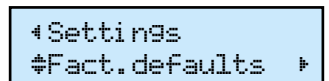

Step 2. Press the enter ◆ button to load factory defaults or the escape • button to cancel.

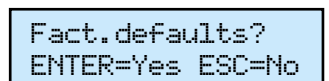

Step 3. The device is restarted; factory default settings and parameters are set. See the list of the details in [Factory Default Settings](#) section.

Enter bootloader mode

The firmware of the device can be upgraded in Bootload mode. If the working mode of the device is not switched to bootload mode automatically, the mode can be also switched manually.

Step 1. Navigate to Settings / Enter Bootload Mode submenu and press the enter **◆** button.

```
←Settings
→Enter bootloa ▶
```

Step 2. Press the enter **◆** button to switch to Bootload mode.

```
Enter Bootload?
ENTER=Yes ESC=No
```

Step 3. LCD will display the IP address of the Bootloader. (The device can be switched to normal operation mode by pressing the reset button or turning the matrix off and on again.)

```
BOOTLOADER IP:
192.168.0.95
```

Resetting the device

Step 1. Navigate to Settings / Reset submenu and press the enter **◆** button.

```
←Settings
→Reset ▶
```

Step 2. Press the enter **◆** button to restart the device or the escape **•** button to cancel.

```
Restart device?
ENTER=Yes ESC=No
```

Step 3. The matrix is restarted immediately.

4.4.2. Network Settings Menu

DHCP setting

Step 1. Navigate to Network Settings / DHCP submenu and press the enter **◆** button.

```
←Network Settin...
→DHCP ▶
```

Step 2. To change the setting, press the enter **◆** button and use the up **▲** and down **▼** buttons to toggle between Enabled and Disabled settings.

```
←DHCP:
Disabled ⇅
```

Step 3. Press the enter **◆** button to save changes.

Step 4. Press the escape **•** button twice to navigate out from the submenu. You will be prompted to apply settings; press the enter **◆** button.

```
Apply settings
ENTER=Yes ESC=No
```

Setting the IP address

Step 1. Navigate to Network Settings / IP Address submenu and press the enter **◆** button.

```
←Network Settin...
→IP Address ▶
```

Step 2. To change the numbers press the enter **◆** button and use the left **◀** and right **▶** buttons to place the cursor to the desired number.

```
←IP Address:
192.168.000.09 ⇅
```

Step 3. Set the numbers by the up **▲** and down **▼** buttons and press the enter **◆** button to save changes.

Step 4. Press the escape **•** button twice to navigate out from the submenu. You will be prompted to apply settings – press the enter **◆** button.

```
Apply settings
ENTER=Yes ESC=No
```

Setting the Subnet mask

Step 1. Navigate to Network Settings / Subnet mask submenu and press the enter **◆** button.

```
←Network
→Subnet mask ▶
```

Step 2. To change the numbers press the enter **◆** button and use left **◀** and right **▶** buttons to place the cursor to the desired number.

```
←Subnet mask:
255.255.255.0 ⇅
```

Step 3. Set the numbers by the up **▲** and down **▼** buttons and press the enter **◆** button to save changes.

Step 4. Press the escape **•** button twice to navigate out from the submenu. You will be prompted to apply settings – press the enter **◆** button.

```
Apply settings
ENTER=Yes ESC=No
```

Setting the Static gateway

Step 1. Navigate to Network Settings / Static gateway submenu, press the enter **◆** button.

```
←Network Settin...
→Static gatewa ▶
```

Step 2. To change the numbers press the enter **◆** button and use left **◀** and right **▶** buttons to place the cursor to the desired number.

```
←Static gateway:
192.168.000.00 ⇅
```

Step 3. Set the numbers by the up **▲** and down **▼** buttons and press the enter **◆** button to save changes.

Step 4. Press the escape **•** button twice to navigate out from the submenu. You will be prompted to apply settings – press the enter **◆** button.

```
Apply settings
ENTER=Yes ESC=No
```

LW2 port setting

Step 1. Navigate to Network Settings / Lw2 Port submenu and press the enter **◆** button.

```
←Network Settin...
→LW2 Port ▶
```

Step 2. To change the numbers press the enter **◆** button and use left **◀** and right **▶** buttons to place the cursor to the desired number.

Step 3. Set the numbers by the up **▲** and down **▼** buttons and press the enter **◆** button to save changes.

```
←LW3 Port:
10001 ⇅
```

Step 4. Press the escape **•** button twice to navigate out from the submenu. You will be prompted to apply settings – press the enter **◆** button.

```
Apply settings
ENTER=Yes ESC=No
```

LW3 port setting

Step 1. Navigate to Network Settings / Lw3 Port submenu and press the enter **◆** button.

Step 2. To change the numbers press the enter **◆** button and use left **◀** and right **▶** buttons to place the cursor to the desired number.

```
←Network Settin...
→LW3 Port ▶
```

Step 3. Set the numbers by the up **▲** and down **▼** buttons and press the enter **◆** button to save changes.

Step 4. Press the escape **•** button twice to navigate out from the submenu. You will be prompted to apply settings – press the enter **◆** button.

```
←LW3 Port:
06107 ⇅
```

```
Apply settings
ENTER=Yes ESC=No
```

Apply settings

Step 1. Navigate to Network Settings / Apply Settings submenu and press the enter **◆** or the right **▶** button.

Step 2. Press the enter **◆** button to confirm.

```
←Network Settin...
→Apply Setting ▶
```

INFO: The MAC address is also available in the Network settings submenu (read-only).

4.4.3. Health Status

INFO: The following values are stored in a non-volatile memory and will not be erased during firmware upgrade.

Voltages

The voltage values are listed measured internally in the matrix.

```
←1V TpsIn1:
1.03V
```

Temperatures

The temperature values are listed measured internally in the matrix.

Operational time

The following time values are measured during operation:

- **Up Time:** The time elapsed from the last boot.
- **Total Up Time:** The total operational time (updated in every 5 minutes).
- **Total high temperature Up Time:** The total operational time when the measured internal temperature was above 70°C (the first 60 seconds is ignored).

ATTENTION! If the measured internal temperature is above 80°C (defined as Very High Temperature) for more than 60 seconds, the matrix is shut down automatically to avoid any damage.

4.4.4. Inputs Menu

TPS inputs (TPSIN1 and TPSIN2)

- **HDCP Enable:** Enabled / Disabled
- **Audio Mode:** Embedded / Aux1 / Aux2 / Aux3 / Aux4. The setting allows to pre-select the desired audio to the video on the given TPS input. The setting will be valid on all TPS/HDMI outputs, where the audio mode is set to Pass-through.
- **PoE Enable:** Enabled / Disabled
- **PoE Status:** ON / OFF
- **TPS Mode:** Auto / HDBaseT / Long reach / LPPF1 / LPPF2
- **TPS Status:** Connected / Disconnected

```
←PoE Enable:
Disabled
```

```
←TPS mode:
HDBaseT
```

HDMI inputs (HDMIIN3 – HDMIIN6)

- **HDCP Enable:** Enabled / Disabled
- **Audio Mode:** Embedded / Aux1 / Aux2 / Aux3 / Aux4. The setting allows to pre-select the desired audio to the video on the given HDMI input. The setting will be valid on all TPS/HDMI outputs, where the audio mode is set to Pass-through.

```
←HDCP Enable:
Enabled
```

```
←Audio Mode:
Embedded
```

Analog audio inputs (AUXIN1 – AUXIN4)

- **Volume:** from -95 to 0 dB, step = 0.375 dB
- **Balance:** from 0 to 100, step = 1 (50 = center)
- **Gain:** from 0 to 21 dB, step = 0.75 dB

4.4.5. Outputs Menu

HDMI outputs (HDMIOUT1 and HDMIOUT2)

- **HDMI Mode:** Auto / DVI / HDMI. The setting determines the output signal type.
- **HDCP Mode:** Auto / Always
- **Audio Mode:** Pass-through / AUX1 / AUX2 / AUX3 / AUX4. The desired audio can be selected to the video on the given HDMI output, thus, the setting will override the input setting. In Pass-through mode, the setting on the input port will be valid.
- **Pwr5V Mode:** Auto / Always on / Always off. The setting lets the source and the sink devices be connected – independently from the transmitted signal.
- **TPG Mode:** Disabled / Enabled. The test pattern generator can be switched on/off.

```
←HDMI mode:
DVI
```

TPS outputs (TPSOUT3 and TPSOUT4)

- **HDMI Mode:** Auto / DVI / HDMI. The setting determines the output signal type.
- **HDCP Mode:** Auto / Always
- **Pwr5V Mode:** Auto / Always on / Always off. The setting lets the source and the sink devices be connected – independently from the transmitted signal.
- **TPG Mode:** Disabled / Enabled. The test pattern generator can be switched on/off.
- **PoE Enable:** Enabled / Disabled
- **PoE Status:** ON / OFF. If power is sent via the current TPS output, the status is ON.
- **TPS Mode:** Auto / HDBaseT / Long reach / LPPF1 / LPPF2
- **TPS Status:** Disconnected / Connected (Read-only parameter)

```
←HDMI mode:
DVI
```

Analog audio outputs (AUXOUT1 and AUXOUT2)

- **Volume:** from -57 to 0 dB, step = 1 dB
- **Balance:** from 0 to 100, step = 1 (50 = center)
- **Gain:** from 0 to 3 dB, step = 1 dB

```
←Volume:
-1dB
```

4.4.6. Signal Info Menu

Basic information is displayed about the transmitted audio and video in the submenu: image resolution, refresh rate, color depth and audio type.

```
←Out1 video In...
Signal Present
```

4.4.7. EDID Settings

The currently emulated EDIDs are shown on each video input and the EDID can be also changed on the input.

INFO: The same settings are available for the HDMI and TPS video inputs.

Changing the emulated EDID

Step 1. Select the desired input, e.g. navigate to EDID settings / Switch submenu and press the enter **◆** button. The submenu is now in **Display mode**.

```
EDID settings
↳Switch
```

The upper line shows the memory place of the currently emulated EDID, e.g. Out1 means the (dynamic) EDID on the HDMI input 1 port. The second line is scrolled automatically to display the manufacturer code, the resolution with the refresh rate and the sink type.

```
In1+Out1
Univ_HDMI_PCM 1920
```

Step 2. Press the enter **◆** button to **Edit mode**:

- Use the left **◀** and right **▶** buttons to select the EDID memory group (Factory, User, Dynamic).

```
In1+Out1
Univ_HDMI_PCM 1920
```

- Use the up **▲** and down **▼** buttons to toggle between the memory places (e.g. D1..D4).

Step 3. Press the enter **◆** button to store the desired combination.

INFO: See the EDID memory structure in [Factory EDID List](#) section.

4.4.8. Device Presets Menu

The matrix has 4 user programmable presets. Each preset stores the full configuration of the matrix. All presets are stored in a non-volatile memory; the matrix keeps presets even in the case of power down. This is the same as using the backup-restore feature of Lightware Device Controller software (see [Matrix Cloning – Backup and Restore the Configuration](#) section), but in this case, the settings are stored in the matrix.

The list of the stored parameters and values can be found in [Content of the Backup File](#) section

Run a preset

Step 1. Navigate to Device Presets / Run Preset submenu and press the enter **◆** button.

```
◀Device Presets
↳Run Preset
```

Step 2. Press the enter **◆** button to activate the Run Preset submenu. Use the up **▲** and down **▼** buttons to toggle between the preset memories.

```
◀Run Preset:
P1:1 preset
```

Step 3. Press the enter **◆** button to run the Preset. The configuration is restored.

Save a preset

Step 1. Navigate to Device Presets / Save Preset submenu and press the enter **◆** button.

```
◀Device Presets
↳Save Preset
```

Step 2. Press the enter **◆** button to activate the Save Preset submenu. Use the up **▲** and down **▼** buttons to toggle between the preset memories.

```
◀Save Preset:
P1:1 preset
```

Step 3. Press the enter **◆** button to save the Preset. The configuration is stored.

Delete a preset

Step 1. Navigate to Device Presets / Delete Preset submenu and press the enter **◆** button.

```
◀Device Presets
↳Delete Preset
```

Step 2. Press the enter **◆** button to activate the Delete Preset submenu. Use the up **▲** and down **▼** buttons to toggle between the preset memories.

```
◀Delete Preset:
P1:1 preset
```

Step 3. Press the enter **◆** button to delete the Preset. The preset memory is erased.

4.4.9. Info Menu

The Info menu displays basic information: the serial number and part number of the matrix; details about the firmware of the CPU and other controllers.

5

Software Control – Lightware Device Controller

The extender can be controlled by a computer through the LAN, RS-232, and USB ports using Lightware Device Controller (LDC). The software can be installed on a Windows PC or macOS. The application can be downloaded from www.lightware.com. The Windows and the Mac versions have the same look and functionality.

- ▶ INSTALL AND UPGRADE
- ▶ RUNNING THE LDC
- ▶ ESTABLISHING THE CONNECTION
- ▶ CROSSPOINT MENU
- ▶ PORT PROPERTIES AND SETTINGS
- ▶ DIAGNOSTIC TOOLS
- ▶ PRESET SETTINGS
- ▶ EDID MENU
- ▶ CONTROL MENU
- ▶ EVENT MANAGER
- ▶ SETTINGS MENU
- ▶ CONFIGURATION CLONING (BACKUP TAB)
- ▶ ADVANCED VIEW WINDOW

5.1. Install and Upgrade

INFO: After the installation, the Windows and the macOS application has the same look and functionality.

Installation for Windows OS

Run the installer. If the User Account Control drops a pop-up message click **Yes**.

During the installation you will be prompted to select the type of the installation: **normal** and the **snapshot** install:

Normal install	Snapshot install
Available for Windows and macOS	Available for Windows
The installer can update only this instance	Cannot be updated
Only one updateable instance can exist for all users	More than one different version can be installed for all users

Comparison of Installation Types

ATTENTION! Using the Normal install as the default choice is highly recommended.

Installation for macOS

Mount the DMG file with double clicking on it and drag the LDC icon over the Applications icon to copy the program into the Applications folder. If you want to copy the LDC into another location just drag the icon over the desired folder.

Upgrading of LDC

Step 1. Run the application.

The **Device Discovery** window appears automatically and the program checks the available updates on Lightware's website and opens the update window if the LDC found updates.

The current and the update version number can be seen at the top of the window and they are shown in this window even with the snapshot install.

The **Update** window can also be opened by clicking the **About** icon and the **Update** button.

Set the desired update setting in the **Options** section.

- If you do not want to check for the updates automatically, uncheck the **circle**, which contains the green tick.
- If you want to postpone the update, a reminder can be set with different delays from the **drop down list**.
- If the proxy settings traverse the update process, set the proper values then click the **OK** button.

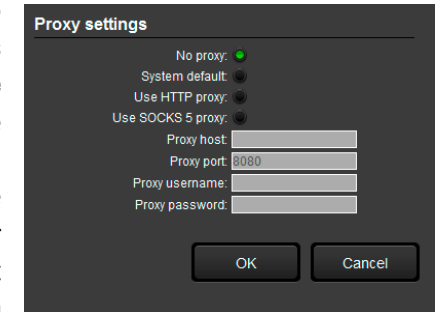

Step 2. Click the **Download update** button to start the upgrading.

The updates can be checked manually by clicking the **Check now** button.

5.2. Running the LDC

The common way to start the software is double-click on the LDC icon. But the LDC can be run by command line parameters as follows:

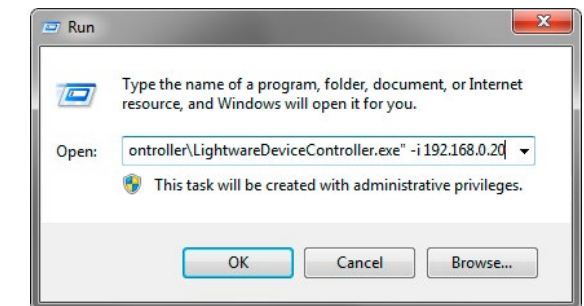

Connecting to a Device with Static IP Address

Format: LightwareDeviceController -i <IP_address>:<port>

Example: LightwareDeviceController -i 192.168.0.20:10001

The LDC is connected to a device with the indicated static IP address directly; the Device Discovery window is not displayed. When the port number is not set, the default port is used: 10001 (LW2 protocol). For LW3 devices use the 6107 port number.

5.3. Establishing the Connection

Step 1. Connect the device to a computer via Ethernet, USB, or RS-232.

Step 2. Run the controller software; device discovery window appears automatically.

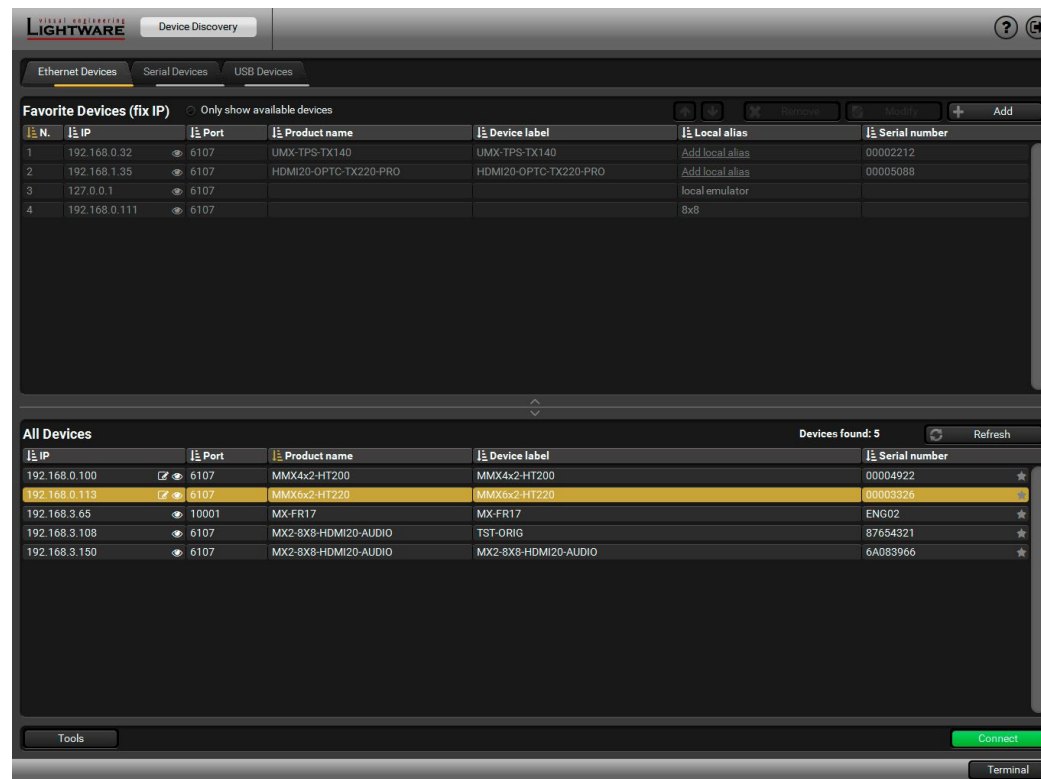

Ethernet Connection in Device Discovery Window

Step 3. Select the unit from the discovered Ethernet devices or under USB devices; when the device is connected through RS-232 click on the **Query** button next to the desired serial port to display the device's name and serial number. Double click on the matrix or select the device and click on the **Connect** button.

ATTENTION! When the device is connected via the local RS-232 port, make sure that Control mode and LW3 protocol are set on the serial port.

Change IP Address

To modify IP address settings quickly it is not necessary to enter the device's settings/network menu, you can set them by clicking the pencil icon beside the IP address. You can see the new settings only in this window.

Identifying the Device

Clicking on the icon results the blinking of the LDC screen for 10 seconds. The feature helps to identify the device itself in the rack shelf.

5.4. Crosspoint Menu

When LDC finds the hardware, it determines the product type, and the LDC starts with the default page, showing the Crosspoint menu.



- 1 Main menu** The available menu items are displayed. The active one is showed with dark grey background color.
- 2 Information ribbon** The label shows the type of the connected device. Device discovery window can be displayed by clicking on this ribbon.
- 3 Submenu selector** The available submenu items are displayed; in the Crosspoint menu, the Video and the Presets submenus are defined.
- 4 Input ports** HDMI and TPS input ports; click on the port to open the port properties window.
- 5 Connections** Light grey square means the port is available but no connection between the input and the output. White square means there is a connection between the input and the output port.
- 6 Output ports** TPS and HDMI output ports; since HDMIOUT1 and TPSOUT1 carry the same A/V signal (such as HDMIOUT2 and TPSOUT2), the selected input will be switched to both output ports.
- 7 Advanced view** Displaying Advanced view page, showing the Terminal window and the LW3 protocol tree.

Port Tiles

The colors of the port tiles and the displayed icons represent different states and information:

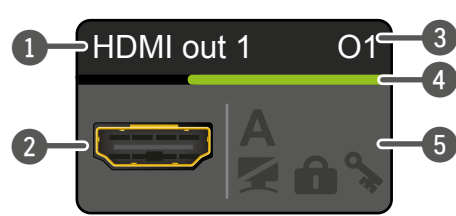

1	Port name
2	Port icon
3	Port number
4	Signal present (green), not present (grey)
5	State indicators

Following icons display different states of the port/signal:

Icon	Icon is grey	Icon is black
	Signal is not encrypted with HDCP	Signal is encrypted with HDCP
	Port is unlocked	Port is locked
	Port is unmuted	Port is muted
	Autoselect is disabled	Autoselect is enabled*

* Displayed only on output ports; when Autoselect is enabled the icon is displayed in green.

5.5. Port Properties and Settings

Click on a port to display its properties; Signal status information and the most important parameters are displayed. Special functions (e.g. frame detector, test pattern generator) are also available on the panel. The look and the content are port-dependent.

5.5.1. Port Name

The name of a port can be changed by typing the new name and clicking the Set button. The following characters are allowed when naming:

Letters (A-Z) and (a-z), hyphen (-), underscore (_), numbers (0-9) and dot (.).

5.5.2. Mute/Unmute

The incoming/outgoing signal can be muted on the input and output ports. If the output is muted, button text is **Muted**. When the port is muted, no signal is present on the output.

INFO: The mute/unmute setting can be set on the output ports independently from each other, e.g. if HDMIOUT1 is muted, TPSOUT1 may be unmuted.

5.5.3. Lock/Unlock

The output ports can be locked by clicking on the button Unlocked. If the output is locked, button text is **Locked**. If the port is locked, its mute state cannot be changed either by the button or by loading a preset.

ATTENTION! Since the output ports are mirrored, the lock/unlock setting is valid on both outputs; e.g. if HDMIOUT1 is locked, TPSOUT1 is also locked.

5.5.4. Autoselect Settings

The autoselect feature can be set on **TPS out** or **HDMI out** properties panel:

See more information about the Autoselect modes in [The Autoselect Feature](#) section.

Input priorities

The available input ports are listed; each one has its own priority number (equal numbers are allowed). If you want to disable a port from the priority list, uncheck the setting next to the priority number and the priority number will be emptied and disabled. A smaller number means higher priority as usual. Priority 31 is the lowest priority, in this case, the port will not be checked and cannot be selected.

Always press the **Set priorities** button after the modification to store the settings.

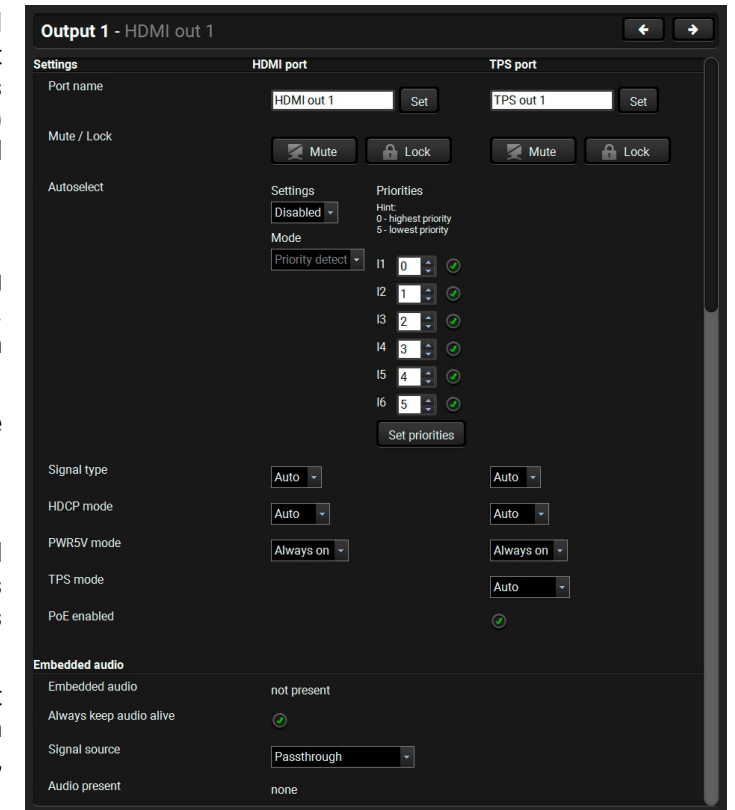

5.5.5. TPS Mode Settings (TPSIN, TPSOUT)

The TPS working mode between the transmitter and the receiver parties is determined by the mode set in them. Both parties influence on the setting which determines the final TPS transmission mode. The TPS settings mode selection is available on the TPS port properties panel.

See more information about TPS modes in [TPS Interface](#) section.

5.5.6. PoE Setting (TPSIN, TPSOUT)

The matrix is able to supply (send remote power) devices through the TPS input and output ports which are compatible with the PoE standard. The PoE feature can be also enabled or disabled in the port properties window.

See more information about PoE feature in [Power over Ethernet \(PoE\)](#) section.

5.5.7. Audio Options

The audio coming from the analog inputs can be assigned to any video input or any video output by a drop-down menu. The input audio modes are valid if the output audio mode is set to Pass-through mode. The output audio modes can override the input audio mode when it is Aux1...Aux4.

See more information about the audio options in [Audio Interface](#) section.

The audio output is determined by the setting of the both the input and the output port. The following table shows the possible combinations:

		Output		
		Pass-through	AUXm	Copy from other output
Input	Embedded	Embedded	AUXm	Copy from other output
	AUXn	AUXn	AUXm	Copy from other output

Audio Source Settings

Always Keep Audio Alive Option

Keeps HDMI and analog audio output alive to maintain audio transmission even when video is not available at the output. If video signal is not present, a 480p black screen will be transmitted automatically.

INFO: When enabled, **no signal mode** is not available in test pattern generator.

5.5.8. Further Settings (HDMIOUT, TPSOUT)

HDMI mode: Auto / DVI / HDMI

The outgoing signal format can be selected by a drop-down menu.

HDCP: Auto / Always

The matrix forces the source sent the signal without encryption if the content allows when **Auto mode** is selected.

Power 5V: Auto / Always on / Always off

The setting lets the source and the sink devices be connected – independently from the transmitted signal.

5.6. Diagnostic Tools

5.6.1. Cable Diagnostics

The cable diagnostics is a useful tool to determine any cable related issues in case of TPS connection. The estimated cable length and the quality of the link are measured periodically and the diagnostic window shows the values in real-time. If the green bars hit the first line in the middle they turn into red. It means the number of the errors – during the extension – is higher than recommended. The link might be alive but recovering of the received data is not guaranteed.

INFO: Each bar represents a differential line in the CATx cable. The inappropriate termination of the cable usually causes high error rates. Check the cable terminations or change the cable.

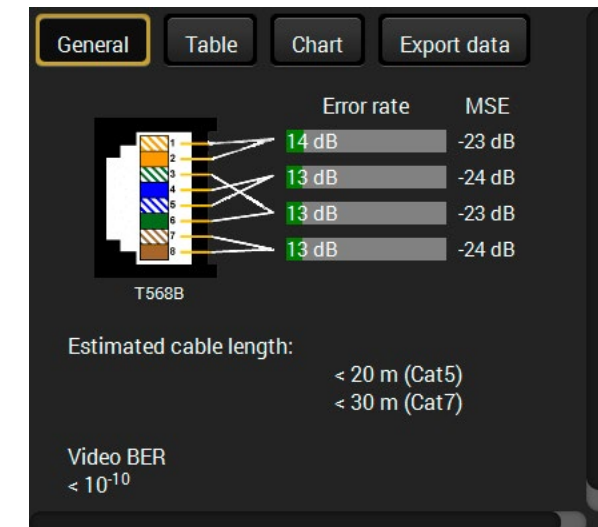

Reference Values

Value	Explanation
10^{-10} - 10^{-9}	Excellent image quality
10^{-8}	Minor error, not recognizable by eyes
10^{-7}	Sometimes recognizable flash on a special test pattern
10^{-6}	Small noise can be seen
10^{-5}	Easy to recognize image error
10^{-4}	Bad image quality

Above displayed Video Bit Error Ratio (BER) means that on average there is 1 bad pixel after 10^{10} pixels, which means the number of the bit errors is about 1 pixel in every 80 seconds at 1080p60 video signal.

INFO: You can find more details about maximum twisted pair cable distances in the [Maximum Twisted Pair Distances](#) section.

Table and Chart Views

Cable diagnostics can be displayed in advanced modes as well. Two ways are available: **table view** and **chart view**. Data can be exported to a file on clicking on the **Export data** button.

General Table Chart Export data									
Date	MSE #1	MSE #2	MSE #3	MSE #4	Error rate #1	Error rate #2	Error rate #3	Error rate #4	Cable length
2016-11-12 09:57:23	-24	-22	-22	-22	28	52	32	34	< 20
2016-11-12 09:57:24	-24	-22	-22	-22	28	52	32	34	< 20
2016-11-12 09:57:25	-24	-22	-23	-23	28	46	30	34	< 20
2016-11-12 09:57:26	-24	-22	-22	-22	26	44	30	36	< 20
2016-11-12 09:57:27	-24	-22	-22	-22	26	44	30	36	< 20
2016-11-12 09:57:28	-24	-22	-23	-22	26	46	32	38	< 20
2016-11-12 09:57:29	-24	-22	-23	-22	26	46	32	38	< 20
2016-11-12 09:57:30	-24	-22	-23	-22	26	46	32	38	< 20

Table view of cable diagnostics

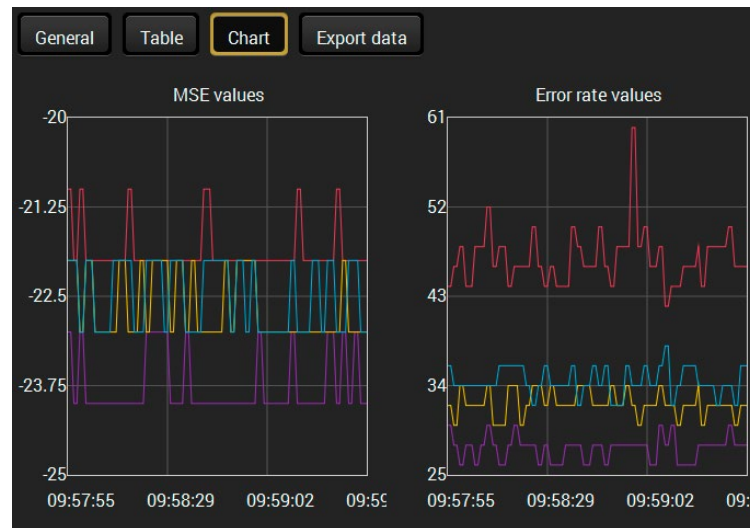
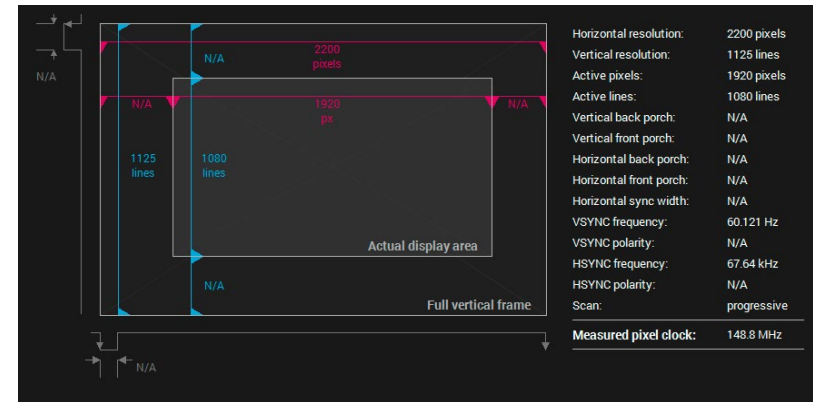

Chart view of cable diagnostics

5.6.2. Frame Detector

The ports can show detailed information about the signal like full size and active video resolution. This feature is a good troubleshooter if compatibility problems occur during system installation. To access this function, open the port properties window and click on **Frame detector** button.



Frame detector window

Lightware's Frame Detector function works like a signal analyzer and makes possible to determine the exact video format that is present on the port, thus helps to identify many problems. E.g. actual timing parameters may differ from the expected and this may cause some displays to drop the picture.

Frame Detector measures detailed timings on the video signals just like a built-in oscilloscope, but it is much more easy to use. Actual display area shows the active video size (light grey). Dark grey area of the full frame is the blanking interval which can contain the info frames and embedded audio data for HDMI signals. Shown values are measured actually on the signal and not retrieved only from the HDMI info frames.

5.6.3. No Sync Screen (Test Pattern)

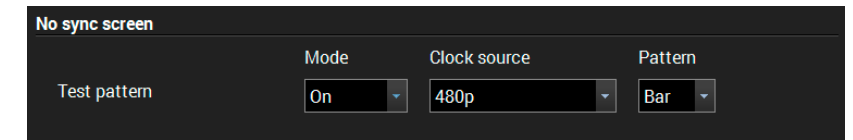

No sync screen options in the port properties window of TPS output

The No sync screen feature generates an image which can be displayed when there is no incoming signal on the port. The following settings can be set for the Test Pattern function:

Mode

- **On:** the video output port always transmits the test pattern.
- **No signal:** the video output port transmits the test pattern if there is no incoming signal on the selected input port.
- **Off:** the test pattern function is disabled, the video output port transmits the video signal of the selected input port.

Clock Source

- 480p
- 576p
- Original video signal

Pattern

- Red
- Green
- Blue
- Black
- White
- Ramp
- Chess
- Bar
- Cycle

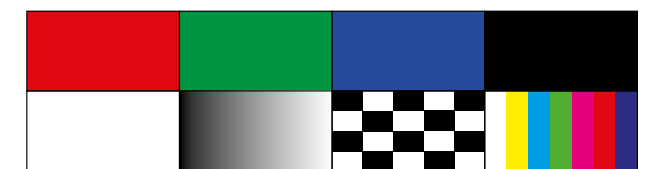

ATTENTION! However the mode of the Test pattern can be set at each port separately, the clock source and the pattern settings are common.

5.7. Preset Settings

The matrix has six user-programmable presets. Each preset stores a configuration regarding the crosspoint and mute state for all inputs/outputs. All presets are stored in a non-volatile memory; the router keeps presets even in the case of power down. The presets can be run from the front panel or by sending protocol commands, too.

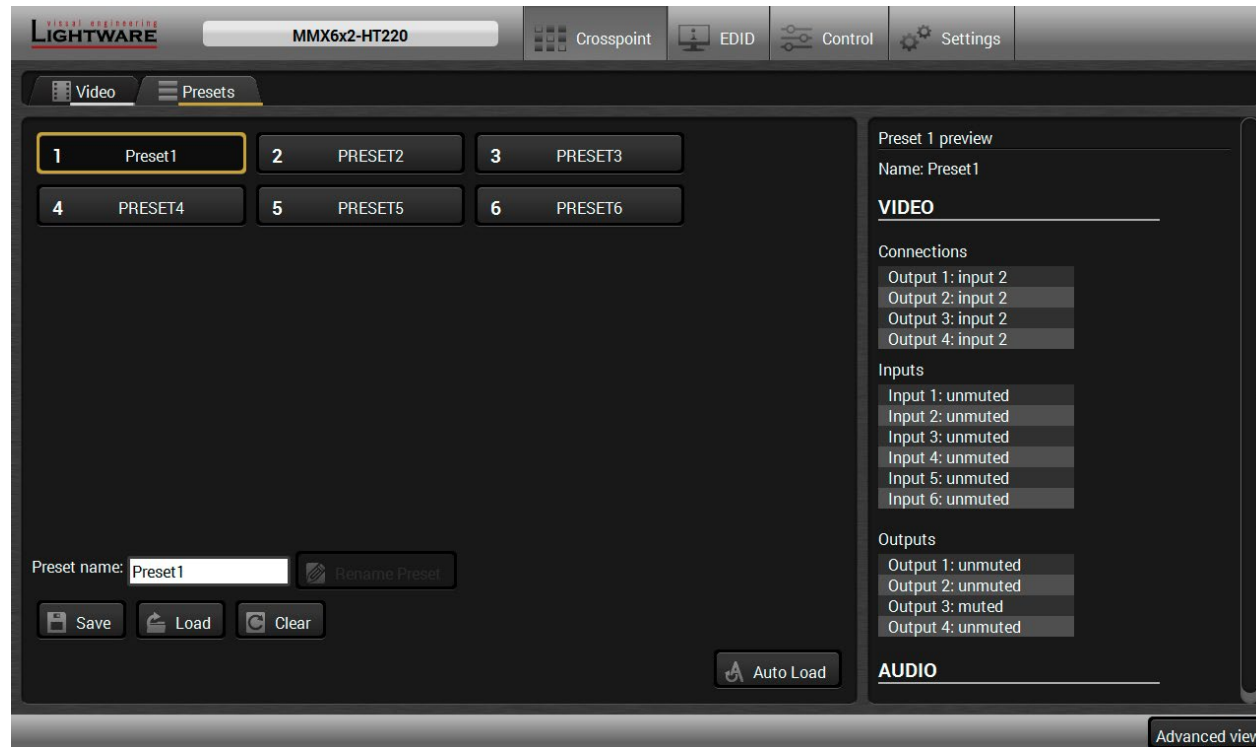

Preset settings

Loading a Preset

Step 1. Select the **Presets** tab from the **Crosspoint** menu.

Step 2. Select the desired preset; check the **Preview** panel and press the **Load** button. Press **Yes** in the confirmation window.

INFO: Presets which were saved by the front panel buttons previously are listed with names Preset1.. Preset6 as default. See the corresponding [Save or Load a Preset](#) section.

Saving a Preset

Step 1. Arrange the desired crosspoint connections.

Step 2. Select the Presets tab from the Crosspoint menu and choose a target preset slot from Preset 1.. Preset 6. Type the desired Preset name in the indicated text field up to 16 characters. The followings are allowed when naming: letters (A-Z and a-z), hyphen (-)underscore (_), and numbers (0-9). Confirm it with **Rename Preset** button.

Step 3. Press the **Save** button and **Yes** to confirm for storing the configuration.

Renaming a Preset

Step 1. Select the desired preset you want to rename.

Step 2. Type the desired name and press the **Rename Preset** button.

Deleting a Preset

Step 1. Select the desired preset you want to delete.

Step 2. Press the **Clear** button and **Yes** to confirm

Auto Load Mode

When the **Auto Load** button is highlighted with green, the mode is active. In this case, confirmation is not required: the selected preset is loaded immediately when the button is pressed.

Save

Rename preset

Clear

Auto Load

Load





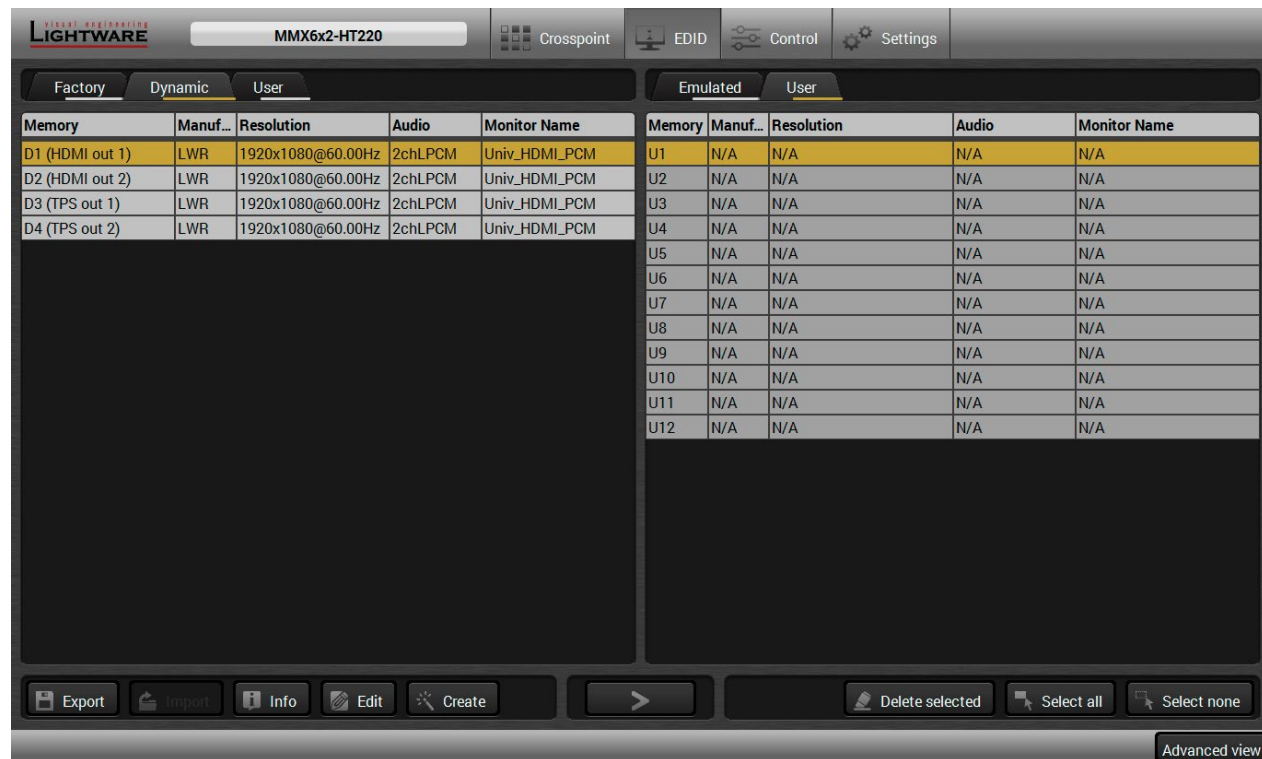



5.8. EDID Menu

Advanced EDID Management can be accessed by selecting the EDID menu. There are two panels: left one contains Source EDIDs, right one contains Destination places where the EDIDs can be emulated or copied.



EDID Menu

Control buttons

	Export	Exporting an EDID (save to a file)		Executing EDID emulation or copying (Transfer button)
	Import	Importing an EDID (load from a file)		Deleting EDID (from User memory)
	Info	Display EDID Summary window		Selecting all memory places in the right panel
	Edit	Opening Advanced EDID Editor with the selected EDID		Selecting none of the memory places in the right panel
	Create	Opening Easy EDID Creator		

5.8.1. Sources and Destinations

The EDID memory consists of four parts:

- **Factory** EDID list shows the pre-programmed EDIDs (F1-F120).
- **Dynamic** EDID list shows the display device connected to the device's outputs. The unit stores the last display devices' EDID on either output, so there is an EDID shown even if there is no display device attached to the output port at the moment.
- **User memory** locations (U1 – U12) can be used to save custom EDIDs.
- **Emulated** EDID list shows the currently emulated EDID for the inputs. The source column displays the memory location that the current EDID was routed from.

The source reads the EDID from the Emulated EDID memory on the INPUT port. Any EDID from any of the User/Factory/Dynamic EDID lists can be copied to the user memory.

There are two types of emulation: **static** and **dynamic**.

- **Static EDID emulation:** an EDID from the Factory or User EDID list is selected. Thus, the Emulated EDID remains the same until the user emulates another EDID.
- **Dynamic EDID emulation:** it can be enabled by selecting D1 or D2 EDID memory. The attached monitor's EDID is copied to the input; if a new monitor is attached to the output, the emulated EDID changes automatically.

5.8.2. EDID Operations

Changing Emulated EDID

- Step 1.** Choose the desired **EDID list** on the source panel and select an EDID.
- Step 2.** Press the **Emulated** button on the top of the Destination panel.
- Step 3.** Select the desired port on the right panel (one or more ports can be selected); the EDID(s) will be highlighted with a yellow cursor.
- Step 4.** Press the **Transfer** button to change the emulated EDID.

Learning an EDID

The process is the same as changing the emulated EDID; the only difference is the Destination panel: press the **User** button. Thus, one or more EDIDs can be copied into the user memory either from the factory memory or from a connected sink (Dynamic).

Exporting an EDID

ATTENTION! This function is working on Windows and Mac OS X operating systems and under Firefox or Chrome web browsers only.

Source EDID can be downloaded as a file (*.bin, *.dat or *.edid) to the computer.

- Step 1.** Select the desired **EDID** from the **Source panel** (highlighted with a yellow cursor).
- Step 2.** Press the **Export** button to open the dialog box and **save** the file to the computer.

Importing an EDID

Previously saved EDID (*.bin, *.dat or *.edid file) can be uploaded to the **user memory**:



- Step 1.** Select the **User** tab in the left panel and select a memory slot.
- Step 2.** Press the **Import** button below the Source panel.
- Step 3.** Browse the file in the opening window then press the **Open** button. Browsed EDID is imported into the selected User memory.

ATTENTION! The imported EDID overwrites the selected memory place even if it is not empty.

Deleting EDID(s)

The EDID(s) from User memory can be deleted as follows:



- Step 1.** Select the **User** tab in the left panel.
- Step 2.** Select the desired memory slot(s); one or more can be selected (**Select all** and **Select None** buttons can be used). The EDID(s) will be highlighted with yellow.
- Step 3.** Press the **Deleted selected** button to delete the EDID(s).

5.8.3. EDID Summary Window

Select an EDID from Source panel and press the **Info** button to display EDID summary.

- General
- Power Management
- Gamma / Colors
- Established Timings
- Standard Timings
- Preferred Timing Mode
- 2nd Descriptor Field
- 3rd Descriptor Field
- 4th Descriptor Field
- CEA General
- CEA Video
- CEA Audio
- CEA Speaker Allocation
- CEA HDMI VSDB
- CEA HDMI Forum VSDB
- CEA YCbCr 4:2:0 VDB
- CEA YCbCr 4:2:0 Capability Map
- CEA Colorimetry
- CEA High Dynamic Range
- CEA Detailed Timing Descriptors

General

EDID version: 1

EDID revision: 3

Manufacturer ID: LWR (Lightware Visual Engineering)

Product ID: 0000

Monitor serial number: Not present

Year of manufacture: 2010

Week of manufacture: Not Used

Signal interface: Digital

Separate Sync H&V: -

Composite sync on H: -

Sync on green: -

Serration on VS: -

Color depth: Undefined

Interface standard: Not defined

Color spaces: RGB 4:4:4

Aspect ratio: 0

Display size: 0 cm X 0 cm

5.8.4. Editing an EDID

Select an EDID from the left panel and press the **Edit** button to display Advanced EDID Editor window. The editor can read and write all descriptors, which are defined in the standards, including the additional CEA extension. Any EDID from the device's memory or a saved EDID file can be loaded into the editor. The software resolves the raw EDID and displays it as readable information to the user. All descriptors can be edited, and saved in an EDID file, or uploaded to the User memory. For more details about EDID Editor please visit our website (www.lightware.com) and download the EDID Editor User's Manual.

- Basic EDID
- Vendor / Product Information
- Display Parameters
- Power Management and Features
- Gamma / Color and Established Timings
- Standard Timings
- Preferred Timing Mode
- 2nd Descriptor Field
- 3rd Descriptor Field
- 4th Descriptor Field
- CEA Extension
- General
- Video Data
- Audio Data
- Speaker Allocation Data
- HDMI VSDB
- HDMI Forum VSDB
- YCbCr 4:2:0 VDB
- YCbCr 4:2:0 Capability Map
- Colorimetry
- High Dynamic Range
- Detailed Timing Descriptor #1
- Detailed Timing Descriptor #2
- Detailed Timing Descriptor #3
- Detailed Timing Descriptor #4
- Detailed Timing Descriptor #5
- Detailed Timing Descriptor #6
- Save EDID

EDID Byte Editor

	0	1	2	3	4	5	6	7	8	9
0	00	FF	FF	FF	FF	FF	FF	00	1E	6D
10	08	5B	40	72	05	00	03	1B	01	03
20	80	3C	22	78	EA	30	35	A7	55	4E
30	A3	26	0F	50	54	21	08	00	71	40
40	81	80	81	C0	A9	C0	D1	C0	81	00
50	01	01	01	01	04	74	00	30	F2	70
60	5A	80	B0	58	8A	00	58	54	21	00
70	00	1E	56	5E	00	A0	A0	A0	29	50
80	30	20	35	00	58	54	21	00	00	1A
90	00	00	00	FD	00	38	3D	1E	87	1E
100	00	0A	20	20	20	20	20	20	00	00
110	00	FC	00	4C	47	20	55	6C	74	72
120	61	20	48	44	0A	20	01	D2		

EDID Editor Window

5.8.5. Creating an EDID

Since above mentioned Advanced EDID Editor needs more complex knowledge about EDID, Lightware introduced a wizard-like interface for fast and easy EDID creation. With Easy EDID Creator it is possible to create custom EDIDs in four simple steps. By clicking on the **Create** button below the left panel, Easy EDID Creator is opened in a new window.

Select Resolution & Interface

Welcome to the Easy EDID Creator!

With this software you are able to create a unique EDID according to your demands. Details can be added or changed in the Advanced EDID Editor later if needed.

Please select the format type and the preferred resolution. If you don't find the proper mode in the list, use the Custom format type setting, enter the resolution and the program will estimate the best blanking times.

Important notes:

- If you want to send audio then you must select HDMI or DisplayPort. DVI and VGA do not support audio transmission.
- Most DVI displays are not able to process HDMI signals. If you have a DVI display, please check its specifications.
- The supported color depth will be 24bits/pixel by default.

Format type: Broadcast

Resolution: 640x480p60

Interface type: VGA, DVI, **HDMI**, DisplayPort

Easy EDID Creator Wizard

5.9. Control Menu

The menu gives the opportunity to set the interfaces which can be used to connect or control third party devices.

5.9.1. RS-232 Tab

Port 1 - Local RS-232

Settings

Port name: Local RS-232

Operation mode: Control

Baud rate: 115200

Data bits: 8

Parity: None

Stop bits: 1

Configuration: 115200, 8N1

Command injection

Enable command injection:

Port: 8001

Status: Disabled

Control Menu, RS-232 Tab

The following settings and functions are available (both on local and TPS serial ports):

- Operation mode: Control, Command Injection, or Disconnect (for more details about serial interface modes see the [Serial Interface](#) section);
- Baud rate: 4800, 7200, 9600, 14400, 19200, 38400, 57600, 115200;
- Data bits: 8 or 9;
- Parity: None, Odd, or Even;
- Stop bits: 1, 1.5, or 2;
- Command injection: enable or disable; port number;
- Control protocol: LW2 or LW3;
- Message sending via serial port;
- Reloading factory defaults (see factory default settings in the [Factory Default Settings](#) section).

5.9.2. Ethernet Tab

Basic information is shown about the network communication; the port names can be changed and each Ethernet port can be enabled/disabled except the Control Ethernet port.

Ethernet Tab

5.9.3. Infra Tab

ATTENTION! The device has no built-in Infrared receiver and transmitter. For the complete usage attach an IR emitter unit to the IR OUT and an IR detector unit to the IR IN connectors.

Infrared (IR) receiver and transmitter options can be found on this tab. There are three submenus available under it: **IR codes**, **Ports**, and **Clear all IR codes**.

IR Codes

User can set the name of the IR code, the fingerprint (hash), and the repeat timeout in ms, as well as actions can be ordered to each IR codes.

ID	Name	Fingerprint (hash)	Detected	Repeat timeout (ms) ?	Actions
code0	code0	00000000	<input type="radio"/>	500	Save Cancel Learn
code1	code1	00000000	<input type="radio"/>	500	Save Cancel Learn
code2	code2	00000000	<input type="radio"/>	500	Save Cancel Learn
code3	code3	00000000	<input type="radio"/>	500	Save Cancel Learn
code4	code4	00000000	<input type="radio"/>	500	Save Cancel Learn
code5	code5	00000000	<input type="radio"/>	500	Save Cancel Learn
code6	code6	00000000	<input type="radio"/>	500	Save Cancel Learn
code7	code7	00000000	<input type="radio"/>	500	Save Cancel Learn
code8	code8	00000000	<input type="radio"/>	500	Save Cancel Learn
code9	code9	00000000	<input type="radio"/>	500	Save Cancel Learn
code10	code10	00000000	<input type="radio"/>	500	Save Cancel Learn
code11	code11	00000000	<input type="radio"/>	500	Save Cancel Learn
code12	code12	00000000	<input type="radio"/>	500	Save Cancel Learn
code13	code13	00000000	<input type="radio"/>	500	Save Cancel Learn
code14	code14	00000000	<input type="radio"/>	500	Save Cancel Learn

IR codes window in Control menu

Description	Function
ID	Code number.
Name	You can give an unique name for the desired code.
Fingerprint (hash)	Fingerprint code in pronto hexa format.
Detected	Indicator gives feedback about the given IR code is detected currently.
Repeat timeout (ms)	You can set a timeout to avoid the involuntary code recurrence.
Actions	Action buttons for the desired IR code: Save: saving the fingerprint. Cancel: canceling the fingerprint. Learn: learning the detected IR code.
Detected IR fingerprints	You can check the detected IR codes in this panel. Pushing Clear button deleting all current fingerprints and switch on or off the automatic scrolling with the Autoscroll pipe.

80 fingerprints can be stored in the device at the same time. Each of them can be ordered to an action in Event Manager. For more details about events see [Event Manager](#) section.

Learning IR Codes

- Step 1.** Connect the IR detector unit to the IR IN port of the receiver.
- Step 2.** Click on the **Learn** button.
- Step 3.** Turn the remote controller to the IR detector. A pop-up window appears in LDC - press your remote button to learn.
- Step 4.** Once the code is received, a new window pops up in LDC - learning completed. Click **OK** to continue.
- Step 5.** Optionally type a unique name for the code in the **Name** text box. The default name is code#, e.g. code0.

Ports

User can set the name and command injection port to each sources and destinations. For more details about IR interface see the [IR Interface](#) section.

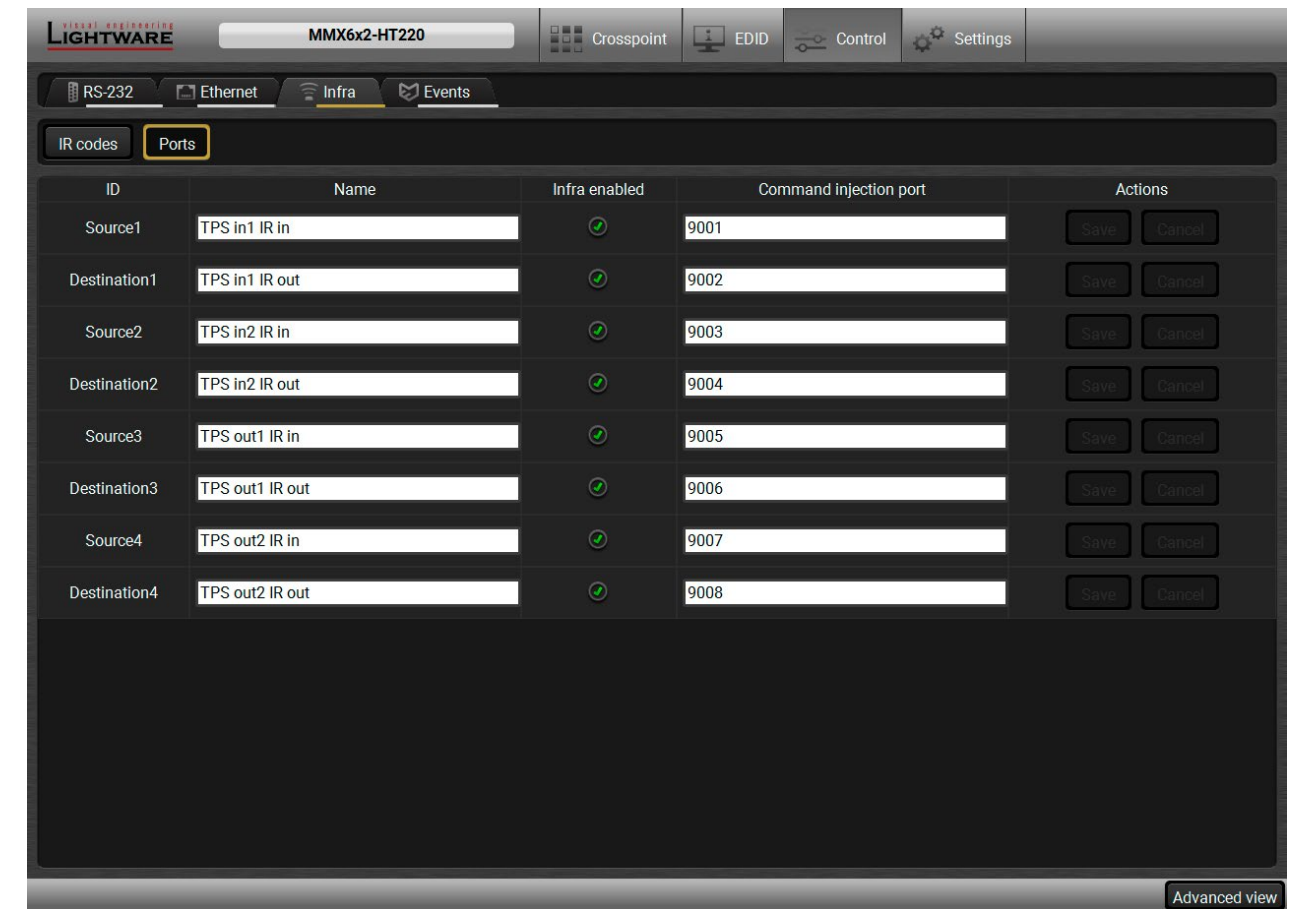

Infra tab - Ports window

Clear all IR codes

Clicking on the button results deleting all stored IR fingerprints.

5.10. Event Manager

The feature means that the device can sense changes on its ports and able to react according to the pre-defined settings. The development idea of the Event manager is based on users' feedbacks. In many cases internal events (such as signal present) are necessary to display but it is not easy when the device is hard to access (e.g. built under the desk).



INFO: For tips and tricks and detailed description about the application of Event Manager, please download the **Event Manager User's Guide** from the Download section on the www.lightware.com.

The Event manager can be configured to perform an action if a condition has been detected. E.g. the desired setup is that after a certain type of signal has been detected on I1 port, the port has to be switched to O1. The settings can be done via the LDC in the Control/Events tab, or by LW3 protocol commands. Configurable events number depends on the device what you are using actually.

Numerous new ideas and requests have been received in connection with the features and settings of the Event manager since the first release. Therefore, the user interface has been re-designed and many new functions implemented. The Event editor can be opened by pressing the Edit button at each Event.

There is a **grey bar** on the left of the Event panel in each line. If a condition and an action are set and the Event is enabled, the bar is displayed **in green**.

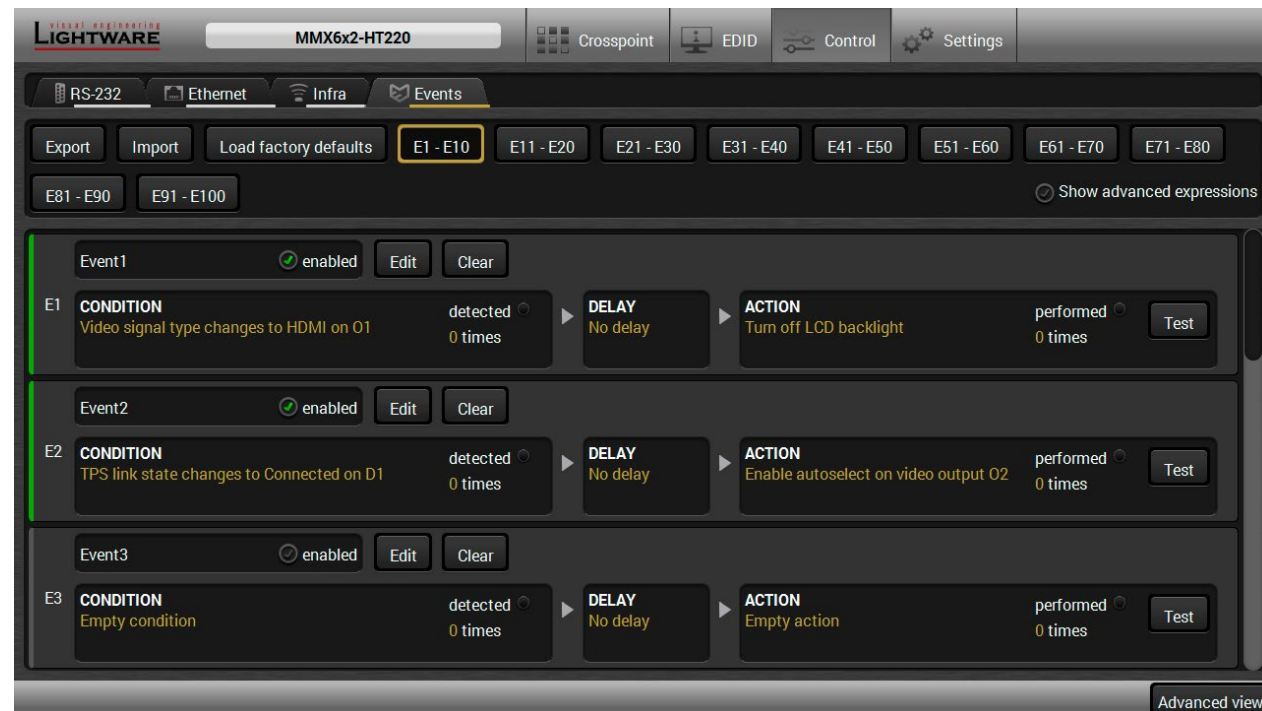

Control menu, Event Manager tab

5.10.1. The Event Editor

Press the **Edit** button in the desired Event line to open the Event editor window.

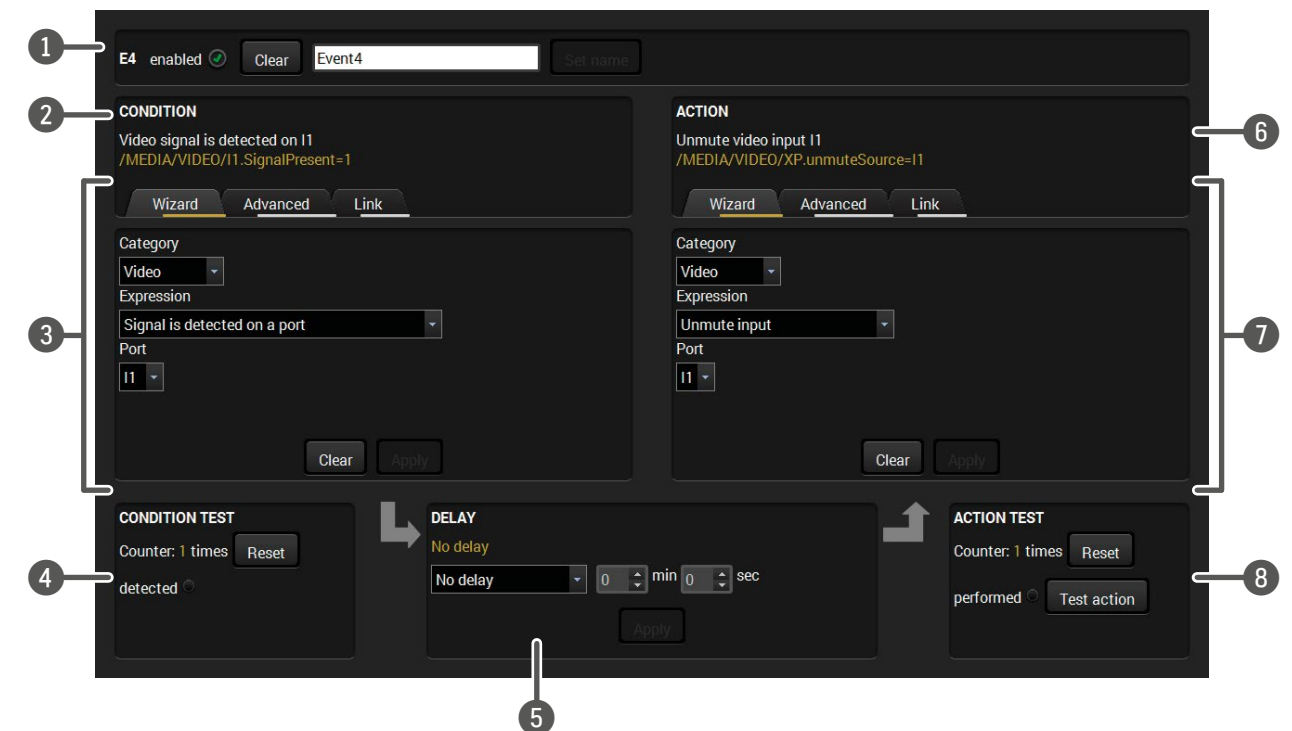

- 1 **Event header** The name of the Event is displayed. Type the desired name and press the Set name button. The Event can be cleared by the Clear button. Use the tick mark to enable/disable the Event.
- 2 **Condition header** If the condition is set, the description (white colored text) and the exact LW3 protocol expression (yellow colored text) can be seen. If the advanced mode was used the description is **Custom condition**.
- 3 **Condition panel** The Wizard, the Advanced or the Link tool is available to set the condition. The parameters and settings are displayed below the buttons.
- 4 **Condition test** The set condition can be tested to see the working method in the practice.
- 5 **Delay settings** The action can be scheduled to follow the condition after the set time value.
- 6 **Action header** If the action is set, the description (white colored text) and the exact LW3 protocol expression (yellow colored text) can be seen. If the advanced mode was used the description is **Custom action**.
- 7 **Action panel** The Wizard, the Advanced or the Link tool is available to set the action. The parameters and settings are displayed below the buttons.
- 8 **Action test** The set action can be tested to see the working method in the practice.

5.10.2. Create or Modify an Event

Wizard Mode

The wizard mode lists the most common conditions and actions, so the user does not have to look for LW3 nodes and properties.

- Step 1.** Click on the **Edit** button of the desired Event; the **Event editor** is displayed.
- Step 2.** The wizard mode is displayed as default. Select the desired **Category** first (e.g. Audio or Video).
- Step 3.** Select the desired **Expression** from the drop-down menu. If any other parameter is necessary to set, it is going to be displayed.
- Step 4.** Press the **Apply** button to store the settings of the Condition.

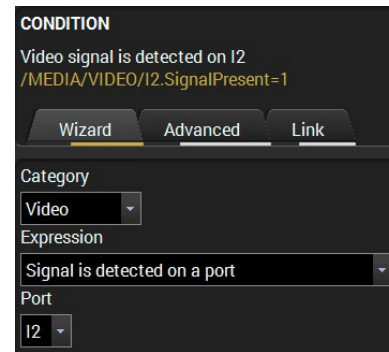

Advanced Mode

The goal of this mode is the same as of the wizard: set the properties and methods for conditions and actions. The difference is the number of the available and usable properties and methods of the LW3 protocol. Advanced mode allows almost all of it.

- Step 1.** Click on the **Edit** button of the desired Event; the **Event editor** is displayed.
- Step 2.** The wizard mode is the default, press the **Advanced** button. The LW3 protocol tree is displayed showing the list of the properties in the drop-down menu. Navigate to the desired node.
- Step 3.** Select the desired **Property** from the menu. The **manual** of the property is displayed below to help to select the necessary property and to set the value.
- Step 4.** Set the desired **value** and **operator**, then press the **Apply** button to store settings.

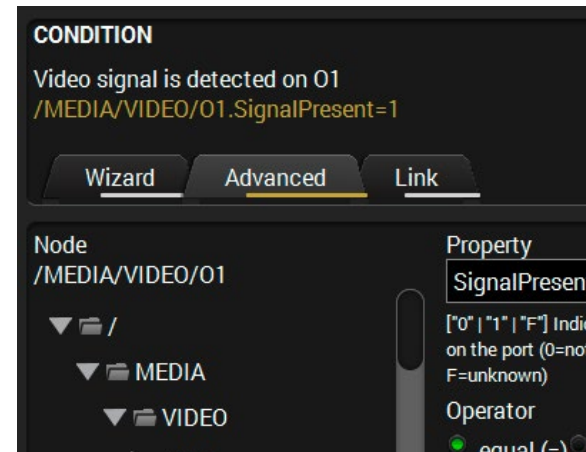

The Link Tool

The new interface allows creating more actions to the same condition. In that case, a condition can trigger more actions. To set such an Event, the Link tool has been introduced.

- Step 1.** Click on the **Edit** button of the desired Event; the **Event editor** is displayed.
- Step 2.** The wizard mode is displayed as default, press the **Link** button.
- Step 3.** All the saved Events are analyzed and the **conditions** are listed (it takes some seconds to finish). The **Show advanced expressions** option allows showing the exact path and set the value of the given property.
- Step 4.** Select the desired **Condition** and press the **Apply** button to store the settings.

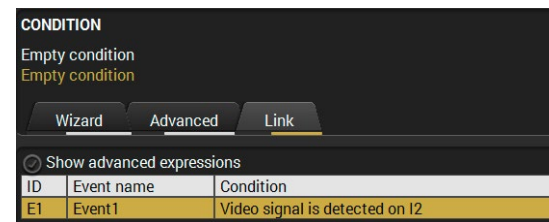

5.10.3. Special Tools and Accessories

The Name of the Event

The name of a port can be changed by typing the new name and clicking the **Set name** button. The following characters are allowed when naming:

Letters (A-Z) and (a-z), numbers (0-9), special characters: hyphen (-), underscore (_), and space ().

Enable or Disable an Event

The set Event can be enabled or disabled in the Event list, or directly in the Event editor window by setting the **tick mark** beside the name.

Testing the Condition

When the desired Condition is arranged, the setting can be tested. The Event list and the Event editor contains a small panel that shows if the set condition is detected and how many times. The **Counter** can be reset by the button in Event editor. If the Condition is true, the **detected** mark turns green for two seconds and the **Counter** is increased.

Testing the Action

The method is the same as testing the Condition, but in this case, the Action can be triggered manually by pressing the **Test** button.

TIPS AND TRICKS: The Test button is also placed on the Action panel in the Event list. Thus, you can check the Actions without opening the Event editor.

Delay the Action

In most cases the Action is performed immediately after the Condition is detected. But sometimes a delay is necessary between the Condition and the Action. Therefore, the new Event manager contains the Delay panel which allows that feature with below settings:

- **No delay:** when the Condition is detected, the Action is launched.
- **Simple delay:** when the Condition is detected, the Action is launched after the set time interval.
- **Still exists:** when the Condition is detected, the Action is launched after the set time interval only if the Condition still exists.
- **Continuously exists:** when the Condition is detected, the Action is launched after the set time interval only if the Condition has been existing continuously.

TIPS AND TRICKS: **Show advanced expressions** option is a useful tool when you look for the path or value of a property but just the expression is displayed. The option is available in the Event list window or when Link tool is used.

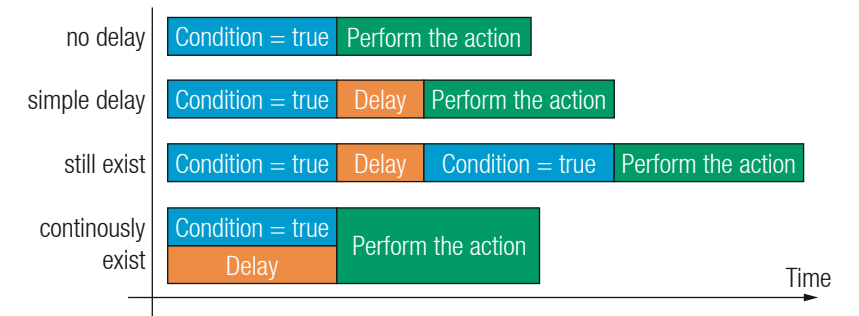

5.10.4. Clear One or More Event(s)

Clear an Event

Press the **Clear** button in the Event list or in the header section in the Event editor.

Clear all Events

When all the Events must be cleared press the **Load factory defaults** button above the Event list. You will be prompted to confirm the process.

5.10.5. Export and Import Events

The feature allows saving all the Events. The backup file can be uploaded to the same device type.

Export all the Events

Step 1. Press the **Export** button above the Event list.

Step 2. The Save as dialog box will appear. Set the desired folder and file name, then press the **Save** button.

The generated file is a simple text file which contains LW3 protocol commands. The file can be viewed by a simple text editor, e.g. Notepad.

ATTENTION! Editing the file is recommended only for expert users.

Import all the Events

Step 1. Press the **Import** button above the Event list.

Step 2. The Open dialog box will appear. Select the desired folder and file, then press the **Open** button.

5.10.6. Event Creating - Example

The following example shows you on a real-life situation how to set up an Event.

The Concept

The MMX6x2-HT220 matrix is connected to a projector by the HDMI out 1 port. The matrix is also connected to the projector by the RS-232 port and can send commands via the serial line.

The task is to turn on the projector when signal is detected on the HDMI out 1 port.

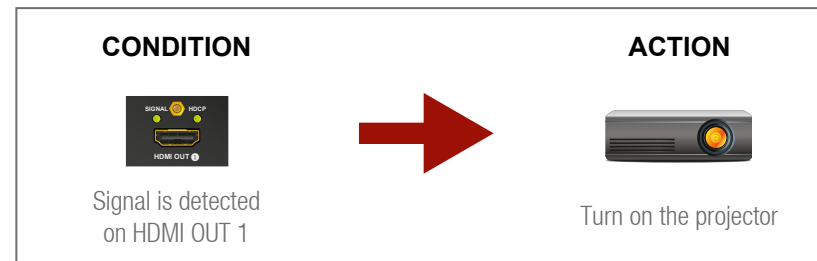

RS-232 Settings

Make sure that the serial line is established between the matrix and the projector. Check that the RS-232 settings of the matrix is set exactly the same which required for the projector: baud rate, data bits, parity, stop bits. The matrix needs to be set to: Control protocol: LW3; and RS-232 mode: Control. See the relevant LDC settings in the [RS-232 Tab](#) section.

Setting the Event

You can create the Event in the Wizard in few simple steps:

Step 1. Set the condition.

Select the required parameters to set the condition:

- **Category:** Video;
- **Expression:** Signal is detected on a port;
- **Port:** 01.

Click on the **Apply** button to complete the procedure. When it is done, the condition appears on the upper side in textual and LW3 command format as well.

Step 2. Set the action.

If the condition is fulfilled, the following action needs to be launched: the receiver sends a command to the projector over the serial line:

- **Power on** - the required command which is accepted by the projector: PWR0<CR><LF>

For this instance the command has to be closed with the <CR><LF> characters so they need to be escaped. You can use the following format for escaping:

```
<command1><\x0d\x0a><command2><\x0d\x0a>...
...<commandn><\x0d\x0a>
```

In the current case the command is: PWR0\x0d\x0a

Select the required parameters to set the action:

- **Category:** RS-232;
- **Expression:** Send RS-232 message;
- **Port:** P1;
- **Message:** PWR0\x0d\x0a

Step 3. Enable the Event.

Select the **E1 enabled** pipe in upper left corner to set the Event as launched.

INFO: If you do not find the required category/expression/etc what you need, choose the Advanced mode in the Wizard where the entire LW3 structure tree is available. For example instead of signal detection you can set a specified resolution or color range either as a condition.

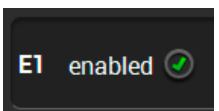
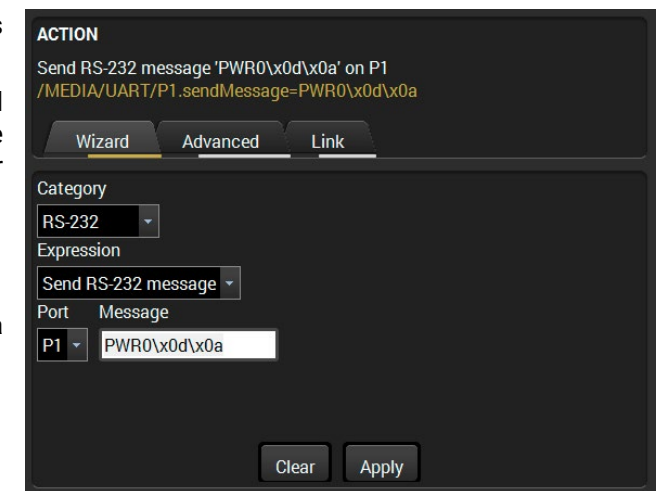
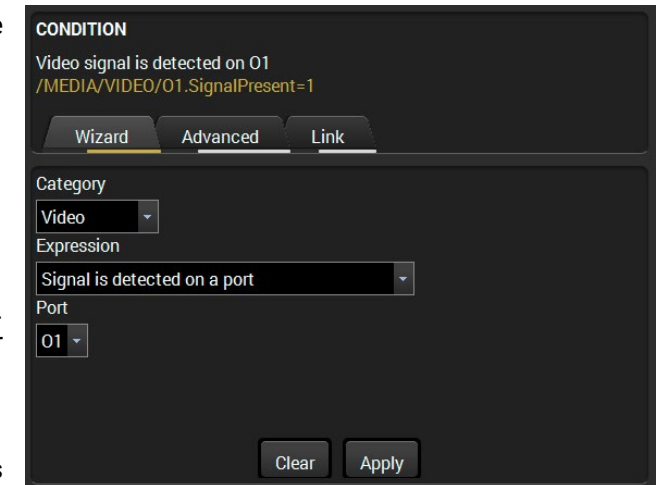

5.11. Settings Menu

5.11.1. Status Tab

General information is shown on this tab, such as device label, part number, serial number and hardware health, voltage and temperature values.

General	
Product name	MMX6x2-HT220
MAC address	A8:D2:36:00:33:26
Hardware version	V11_AAA0
Device label	MMX6x2-HT220 <input type="button" value="Set"/>
Part number	91310032
Serial number	00003326

Operation	
System uptime	0 days 06h 23m 21s
Operation time	41 days 14h 23m 18s
High temp operation time	0 days 00h 00m 00s

Firmware versions	
CPU firmware version	1.1.3b1 r9
TPS in firmware version	1.1.0b0 r63
TPS out firmware version	1.1.0b0 r63
Control board firmware version	0.0.1b0

Temperatures	
CPU temperature	41 °C (21 °C min, 54 °C max)
TPS out temperature	42 °C (20.5 °C min, 58.62 °C max)
TPS in temperature	40.25 °C (19.88 °C min, 53.88 °C max)

Voltages	
48V	48 V (0 V min, 48 V max)
Main 5V	5.06 V (3.54 V min, 5.09 V max)
Main 3.3V	3.31 V (3.3 V min, 3.32 V max)
TPS 1.8V	1.81 V (0.64 V min, 1.82 V max)
HDMI inputs 1.3V	1.34 V (0 V min, 1.35 V max)
HDMI outputs 1.3V	1.34 V (0 V min, 1.35 V max)
TPS input1 1V	1.03 V (0.01 V min, 1.03 V max)
TPS Input2 1V	1.03 V (0 V min, 1.04 V max)
TPS outputs 1V	1.03 V (0 V min, 1.04 V max)

Fan	
Fan mode	Auto
Fan speed	5%

Status Tab

5.11.2. Network Tab

Network-related settings are available on the tab.

General	
Current IP address	192.168.0.112
Current subnet mask	255.255.255.0
Current gateway address	192.168.0.1
Obtain IP address automatically (DHCP, AutoIP)	<input checked="" type="checkbox"/>
Static IP address	192.168.0.100
Static subnet mask	255.255.255.0
Static gateway address	192.168.0.1
LW2 port	10001
LW3 port	6107
HTTP port	80
Apply changes	<input type="button" value="Apply changes"/> <input type="button" value="Cancel"/> <input type="button" value="Load factory defaults"/>

Network Tab

When dynamic IP address is used, the DHCP option is ticked; the IP settings of the matrix is shown in the first three lines. When static IP address is used, the DHCP option shall be unticked and below three lines can be used to define the IP settings. The device is able to communicate with LW2 and LW3 protocols, the ports can be set in the displayed lines.

ATTENTION! Connecting to the matrix via Ethernet and using LW2 port no. (default is 10001) the device will accept LW2 protocol commands. Using LW3 port no. (default is 6107) the device will accept LW3 protocol commands.

5.11.3. System Tab

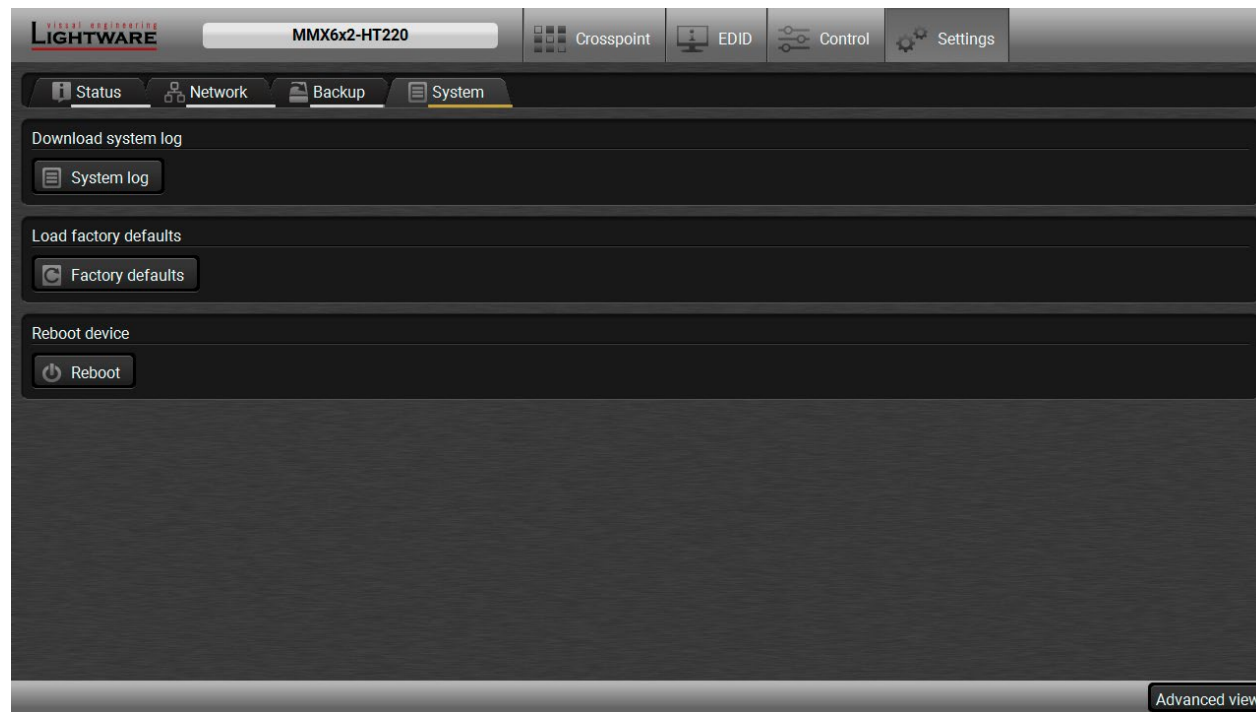

System tab

System log button

Logged events can be collected and saved into a file which is useful when troubleshooting or in another special case for analyzing. Data collecting may take some minutes. You will be prompted about log generating before starting. When the collecting is done, the Save as window appears; select the desired location and press the **Save** button.

Factory defaults button

Factory default values can be restored by pressing the button; you will be asked to confirm. The connection will be terminated and the device is rebooted. Factory default values are listed in [Factory Default Settings](#) section.

Reboot button

The device can be restarted; the connection will be terminated.

5.12. Configuration Cloning (Backup Tab)

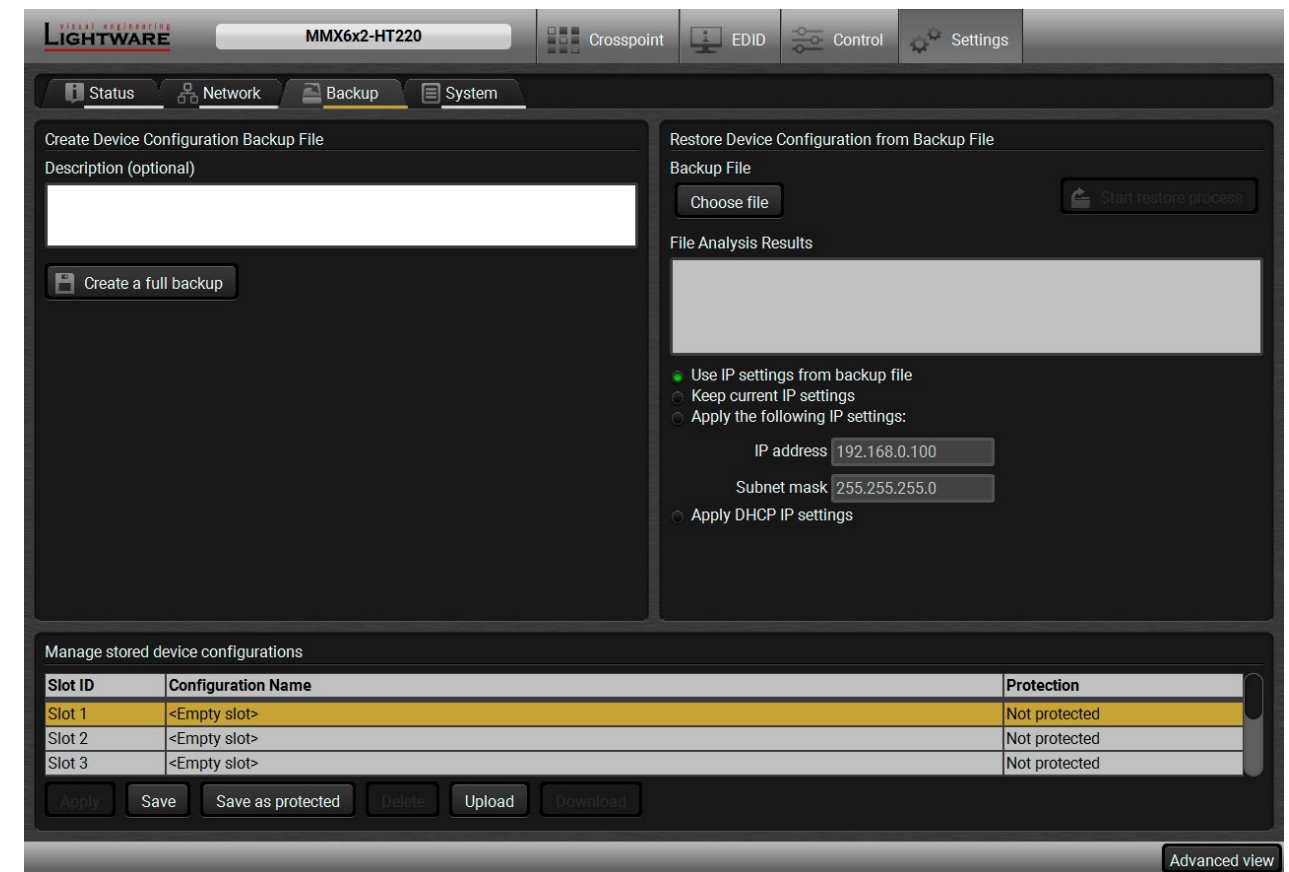

Backup Tab

The configuration cloning of Lightware LW3 devices is a simple method that eliminates the need to repeatedly configure certain devices to have identical (non-factory) settings. If the devices are installed in the same type of system multiple times then it is enough to set up only one device to fit the user's needs and then copy those settings to the others, thus saving time and resources.

5.12.1. Cloning Steps in a Nutshell

Installing multiple devices with the same customized configuration settings can be done in a few easy steps:

Step 1. Configure one device with all your desired settings with the LDC software.

Step 2. Backup the full configuration file to your computer.

Step 3. If needed, make some modifications to the configuration file using a text editor (e.g. Notepad). E.g. modifying the static IP address is needed when DHCP is not used.

Step 4. Connect to the other device which has to be configured and upload (restore) your configuration file.

Step 5. Done! You can have as many totally identical, customized devices as you like.

5.12.2. Save the Settings of the Device (Backup)

- Step 1.** Apply the desired settings in the transmitter (port parameters, crosspoint, etc.)
- Step 2.** Select the **Settings / Backup** tab from the menu.
- Step 3.** Write a short **description** in the text box on the left (optional).
- Step 4.** Press the **Create a full backup** button. You will be prompted to save the file to the computer. The default file name is the following:

```
BACKUP_<DEVICE TYPE>_SN<SERIAL NUMBER>.LW3
```

- Step 5.** Set the desired **file name**, select the folder and **save** the file.

TIPS AND TRICKS: Using the exact product type in the filename is recommended since it makes the file usage more comfortable.

About the Backup File

The backup file is a simple text file which contains LW3 protocol commands. The first line is the description, and the further lines are the commands which will be executed during the restore process. The file can be viewed (and/or edited) by a simple text editor, e.g. Notepad.

ATTENTION! Editing the command lines is only recommended for expert users.

See the entire list of saved data in the [Content of the Backup File](#) section.

5.12.3. Upload the Settings to a Device (Restore)

WARNING! Please note that the settings will be permanently overwritten with the restored parameters in the device. Withdrawal is not possible.

ATTENTION! The cloning is successful when the backup file is downloaded from the same type of source device as the destination device.

The Restoring Process

- Step 1.** Select the **Settings / Backup** tab from the menu.
- Step 2.** Click on the **Choose file** button on the right panel and **browse** the desired file.
- Step 3.** The file is checked and the result will be displayed in the textbox below. If the file is correct, the settings can be restored.
- Step 4.** Choose **IP settings** what you want to use after backup. You can apply settings from the backup file, keep actual settings, set it manually in a dialog box or apply DHCP.
- Step 5.** Press the **Start restore process** button and click on the **Yes** button when asked.
- Step 6.** Reboot the device to apply the network settings after finishing.

5.12.4. Create and Restore Backups from the Device Memory

MMX6x2-HT series matrix is able to store backups in its own memory and can be recalled from there so user does not need to save backup files to the local computer. Four slots are available for this purpose.

Slot ID	Configuration Name	Protection
Slot 1	Preset_0720	Not protected
Slot 2	backup_0125	Protected
Slot 3	<Empty slot>	Not protected
Slot 4	<Empty slot>	Not protected

Apply Save Save as protected Delete Upload Download

You can save presets as not protected with using **Save** button and as protected with using the **Save as protected** button. Restoring a preset select on the slot of the desired backup and click on the **Apply** button. You can save presets from a file from your local computer clicking on the **Upload** button and you can also save a preset from the device's memory to a backup file with using the **Download** button. If you do not need a saved preset any more, select it and click on the **Delete** button.

WARNING! Loading factory default settings will erase all presets which has been saved in the device memory!

5.13. Advanced View Window

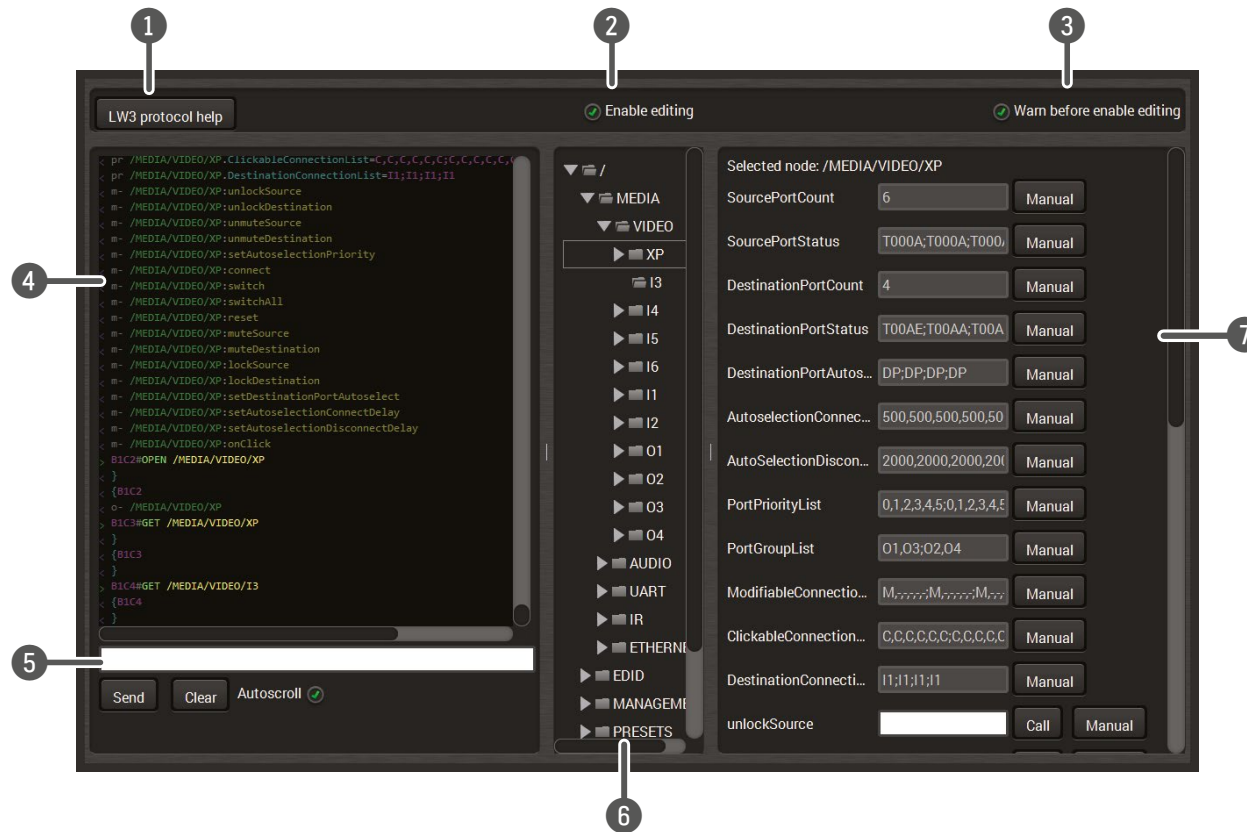

LDC - Advanced view window

- 1 **LW3 protocol help** Pushing the button results a help window opening which describes the most important information about LW3 protocol commands in HTML format.
- 2 **Edit mode** The default appearance is the read-only mode. If you want to modify the values or parameters, tick the option. You will be prompted to confirm your selection.
- 3 **Warning mode** If this pipe checked in, a warning window pops up when you enable Edit mode.
- 4 **Terminal window** Commands and responses with time and date are listed in this window. Sent command starts with '>' character, received response starts with '<' character. The color of each item depends on the type of the command and response. The content of the window can be emptied by the **Clear** button. If the **Autoscroll** option is ticked, the list is scrolled automatically when a new line is added.
- 5 **Command line** Type the desired command and execute it by the **Send** button. Clear all current commands and responses in the Terminal window by the **Clear** button.
- 6 **Protocol tree** LW3 protocol tree; select an item to see its content.
- 7 **Node list** Correspondent parameters and nodes are shown which are connected to the selected item in the protocol tree.
 - Manual button:** Manual (short description) of the node can be called and displayed in the terminal window.
 - Set button:** Saves the value/parameter typed in the textbox.
 - Call button:** Calls the method, e.g. reloads factory default settings.

6

LW2 Programmers' Reference

Lightware MMX6x2-HT family can be controlled with external devices which can communicate according to the extender protocol. The supported LW2 commands are described in this chapter.

- ▶ [LW2 PROTOCOL DESCRIPTION](#)
- ▶ [GENERAL LW2 COMMANDS](#)
- ▶ [PORT AND CROSSPOINT SETTINGS](#)
- ▶ [NETWORK CONFIGURATION](#)
- ▶ [LW2 COMMANDS – QUICK SUMMARY](#)

6.1. LW2 Protocol Description

The device accepts commands surrounded by curly brackets - { } - and responds data surrounded by round brackets - () - only if a command was successfully executed.

Format	Explanation
<in>	Input number in 1 or 2 digit ASCII format (01, 5, 07, 16, etc.)
<out>	Output number in 1 or 2 digit ASCII format
<in ² >	Input number in 2 digit ASCII format (01, 02, 10, 12 etc.)
<out ² >	Output number in 2 digit ASCII format (01, 02, 10, 12 etc.)
<loc>	Location number in 1, 2 or 3 digit ASCII format
<id>	id number in 1 or 2 digit ASCII format
<id ² >	id number in 2 digit ASCII format
CrLf	Carriage return, Line feed (0x0D, 0x0A)
·	Space character (0x20)
→	Each command issued by the controller
←	Each response received from the router

6.2. General LW2 Commands

6.2.1. View Product Type

Description: The device responds its name.

Format	Example
Command {i}	→ {i}
Response (<PRODUCT_TYPE>CrLf	← (I:MMX6x2-HT220)

Explanation: The connected device is an MMX6x2-HT220.

Legend: <PRODUCT_TYPE> shows type.

6.2.2. View Serial Number

Description: The device responds its 8-digit serial number.

Format	Example
Command {s}	→ {s}
Response (SN:<SERIAL_N>)CrLf	← (SN:7A000941)

6.2.3. Query Control Protocol

Description: The device can be controlled with different control protocols. This command queries the active protocol of the currently used control interface.

Format	Example
Command {P_?}	→ {p_?}
Response (CURRENT•PROTOCOL•=#<protocol>)CrLf	← (CURRENT PROTOCOL = #1)

Explanation: The device communicates with LW2 protocol.

6.2.4. View Firmware Version of the CPU

Description: View the CPU firmware revision.

Format	Example
Command {f}	→ {f}
Response (FW:<FW_VER><s>)CrLf	← (FW:1.1.3b1 r9)

Legend: <FW_VER> is the firmware version. It is followed by <s> string which may indicate special versions. <s>=r indicates standard version.

INFO: The version number of the firmware package and the CPU firmware can be different. The firmware package contains more different firmware component, the CPU firmware is the part of those ones.

6.2.5. Connection Test

Description: Simple test to see if the connection is established successfully.

Format	Example
Command {PING}	→ {ping}
Response (PONG!)CrLf	← (PONG!)

6.2.6. Compile Time

Description: Returns the date, when the microcontroller firmware was compiled.

Format	Example
Command {CT}	→ {ct}
Response (Complied: <DATE&TIME>)CrLf	← (Complied: Oct 10 2017 16:33:59)

6.2.7. View Installed Board(s)

Description: Shows the hardware name and revision of the installed boards.

Format	Example
Command {is}	→ {is}
Response (SL#•0•<MB_DESC>)CrLf (SL•END)CrLf	← (SL# 0 MMX6x2-HT220 V12_AAA0) ← (SL END)

Explanation: The device reports its motherboard (slot 0).

6.2.8. View Firmware for all Controllers'

Description: Shows the firmware versions of all installed controllers.

Format	Example
Command {FC}	→ {fc}
Response (CF•<DESC>)CrLf (CF•<DESC>)CrLf ... (CF END)CrLf	← (CF MMX6x2-HT220 1.1.3b1 r9) ← (CF END)

Explanation: The device has one control panel.

6.2.9. Restart the Matrix Router

Description: The device can be restarted without unplugging power.

Format	Example
Command {RST}	→ {RST}
Response	←

Explanation: The device reboots; no response is sent in this case.

6.2.10. Query Health Status

Description: The device can be restarted without unplugging power.

Format	Example
Command {ST}	→ {st}
Response (ST•<DESC>)CrLf	← (ST CPU 1.03V 1.03V 1.03V 1.81V 1.34V 1.34V 3.31V 5.07V 48.00V 35.40C 35.42C 0.00C 31.62C 35.38C)

6.2.11. Restore Factory Default Settings

Description: Settings can be reset to factory default values as follows:

Format	Example
Command {FACTORY=ALL}	→ {factory=all}
Response (FACTORY ALL...)CrLf	← (FACTORY ALL...)

Explanation: All settings and parameters are reset to factory default, see the table in [Factory Default Settings](#) section.

6.3. Port and Crosspoint Settings

6.3.1. Switch One Input to One Output

Description: Switch input <in> to output <out>.

Format	Example
Command {<in>@<out>}	→ {2@1}
Response (O<out?>*I<in?>)CrLf	← (001 I02)

Explanation: Input 1 is switched to output 2.

ATTENTION! The response of this command does not show if the output is muted. To check the mute status a separate query has to be used like {VC}. See [View Connection State on the Output](#) section. To achieve multiple switches executed together, see [Batch Switch Outputs](#) section.

6.3.2. Mute Specified Output

Description: Mute output <out>. The output signal is turned off.

Format	Example
Command {#<out>}	→ {#01}
Response (1MT<out?>)CrLf	← (1MT01)

Explanation: O1 port is muted.

ATTENTION! Muting does not change the state of the crosspoint but disables the output itself. This way the last connection can be easily restored with an unmute command. Switching a muted output does not unmute the output.

6.3.3. Unmute Specified Output

Description: Unmute output <out>.

Format	Example
Command {+<out>}	→ {+01}
Response (0MT<out?>)CrLf	← (0MT01)

Explanation: O1 port is unmuted.

INFO: Unmuting an output makes the previous connection active as the state of the crosspoint has not been changed with the muting command, only the output was disabled.

6.3.4. Lock the Output

Description: Lock output <out>. Output's state cannot be changed until unlocking

Format	Example
Command {#<out>}	→ {#>01}
Response (1LO<out?>)CrLf	← (1LO01)

Explanation: O1 port is locked.

6.3.5. Unlock the Output

Description: Unlock output <out>. The connection on output can be changed.

Format	Example
Command {+<out>}	→ {+<01}
Response (0LO<out?>)CrLf	← (0LO01)

Explanation: Output 1 is unlocked.

INFO: The device issues the above response regardless of the previous state of the output (either it was locked or unlocked).

6.3.6. View Connection State on the Output

Description: Viewing the output's connection results in different response length, because it depends on the device. The response below refers to an MMX6x2-HT220.

Format	Example
Command {VC}	→ {vc}
Response (ALL•<O1>•<O2>•<O3>•<O4>)CrLf	← (ALL 03 04 03 04)

Legend: All <Ox> indexes show the corresponding output's connection state. If value <O1> equals 03 it means that output 1 is connected to input 3. All <Ox> indexes are two digit ASCII characters (01, 02, 04, etc.).

State letters

Letter	State	Example
L	Output is locked	L01
M	Output is muted	M01
U	Output is locked and muted	U01

Explanation: I3 is switched to O1 and O3. I4 is switched to O2 and O4.

INFO: As the output ports are mirrored O1 and O3 transmit the same input, such as O2 and O4.

6.3.7. View Crosspoint Size

Description: Shows the physical crosspoint size.

Format	Example
Command {getsize}	→ {getsize}
Response (SIZE=<size>)CrLf	← (SIZE=6x4)

Explanation: The device reports that it has a video crosspoint with 6 inputs and 4 outputs.

6.3.8. Batch Switch Outputs

Description: The device is capable of switching multiple outputs exactly at the same time. To do this, the normal switch commands have to be used. If the switch commands arrive at the device with less than 10 milliseconds delay, the commands are collected and changes the output connections together.

Required circumstances:

- Switch commands have this format: {<in>@<out>}{<in>@<out>}
- The delay between two '}' characters must be below 10 milliseconds
- No other command or junk character is allowed between switch commands
- Affected outputs must not be locked

If any of the above circumstances fail, then the commands will be processed separately and the output connections will change one by one.

ATTENTION! The delay timeout applies for the receiving time of characters. Please note that if LAN connection is used then the network may cause additional delays. This could result that batch switching does not occur. Below example shows a command that resulted batch switching:

One by one commands	Batch commands
→ {02@01 V}	→ {02@01 V}{01@01 A}
← (001 I02 V)CrLf	← (001 I02 V)CrLf
→ {01@01 A}	← (001 I01 A)CrLf
← (001 I01 A)CrLf	

6.3.9. Change the Autoselect Mode

Description: The autoselect mode of the video outputs can be changed.

Format		Example	
Command	{AS_V<out>=<state>; <mode>}	→	{as_v1=E;P}
Response	(AS_V<out>=<state>;<mode>)CrLf	←	(AS_V1=E;P)

Legend: The output numbers are listed in [Input and Output Port Numbering](#) section.

Letter	State
F	First detect mode
P	Priority detect mode
L	Las

Explanation: The Autoselect mode of video output1 (and output 3) is enabled and set to Priority mode.

INFO: The Autoselect mode can be queried by typing the "as_v<out>=?" command.

6.3.10. Change the Video Input Priorities

Description: The settings of video input priority can be changed as follows.

Format		Example	
Command	{PRIO_V<out>=<in1_prio>; <in2_prio>;...;<inn_prio>}	→	{prio_v1=1;0;2;3;4;5}
Response	(PRIO_V<out>=<in1_prio>;<in2_prio>;...;<inn_prio>)CrLf	←	(PRIO_V1=1;0;2;3;4;5)

Legend: <out>: The output port number: V1/V3 and V2/V4.

<in1_prio>...<inn_prio>: Input ports' priority number. See more details about port numbering in section [Input and Output Port Numbering](#) section.

Explanation: Input 2 has the highest priority (0), Input 1 has the second highest (1). Input 6 has the lowest priority (5).

ATTENTION! Always set all the ports' priority when changing, otherwise, the change will not be executed and the response will be the current setting (like querying the priority setting).

6.4. Network Configuration

6.4.1. Query the Current IP Status

Description: IP status can be queried as follows:

Format	Example
Command {IP_STAT=?}	→ {ip_stat=?}
Response (IP_STAT=<type>;<ip_address>;<subnet_mask>;<gateway_addr>)CrLf	← (IP_STAT=0;192.168.0.95;255.255.255.0;192.168.0.1)

Legend:

- <type>: 0 = static IP; 1 = DHCP.
- <ip_addr>: IP address (four decimal octets separated by dots).
- <subnet_mask>: Subnet mask (four decimal octets separated by dots).
- <gateway_addr>: Gateway address (four decimal octets separated by dots).

Explanation: The device has a static (fix) IP address: 192.168.0.95; the subnet mask is 255.255.255.0, the gateway address is 192.168.0.1.

6.4.2. Query the IP Address

Description: IP address can be queried as follows:

Format	Example
Command {IP_ADDRESS=?}	→ {ip_address=?}
Response (IP_ADDRESS=<type>;<ip_address>)CrLf	← (IP_ADDRESS=0;192.168.0.110)

Legend:

- <type>: 0 = static IP; 1 = DHCP
- <ip_addr>: IP address (four decimal octets separated by dots).

INFO: The response contains the fix IP address that is stored in the device even if DHCP is enabled; in this case, this IP address is not valid.

6.4.3. Set the IP Address

Description: IP address can be set as follows:

Format	Example
Command {IP_ADDRESS=<type>;<ip_address>}	→ {ip_address=0;192.168.0.110}
Response (IP_ADDRESS=<type>;<ip_address>)CrLf	← (IP_ADDRESS=0;192.168.0.110)

Legend: <type>: 0 = static IP; 1 = DHCP

6.4.4. Query the Subnet Mask

Description: Subnet mask can be queried as follows.

Format	Example
Command {IP_NETMASK=?}	→ {ip_netmask=?}
Response (IP_NETMASK=<subnet_mask>)CrLf	← (IP_NETMASK=255.255.255.0)

Legend: <subnet_mask>: Four decimal octets separated by dots.

INFO: The response contains the fix IP subnet mask value that is stored in the device even if DHCP is enabled; in this case, this IP subnet mask is not valid.

6.4.5. Set the Subnet Mask

Description: Subnet mask can be set as follows.

Format	Example
Command {IP_NETMASK=<subnet_mask>}	→ {ip_netmask=255.255.255.0}
Response (IP_NETMASK=<subnet_mask>)CrLf	← (IP_NETMASK=255.255.255.0)

Legend: <subnet_mask>: Four decimal octets separated by dots.

6.4.6. Query the Gateway Address

Description: Gateway address can be set as follows.

Format	Example
Command {IP_GATEWAY=?}	→ {ip_gateway=?}
Response (IP_GATEWAY=<gateway_addr>)CrLf	← (IP_GATEWAY=192.168.0.50)

Legend: <gateway_addr>: Four decimal octets separated by dots.

INFO: The response contains the static IP gateway address that is stored in the device even if DHCP is enabled. In that case, the latest valid gateway address (for static IP) is stored.

6.4.7. Set the Gateway Address

Description: Gateway address can be set as follows.

Format	Example
Command {IP_GATEWAY=<gateway_addr>}	→ {ip_gateway=192.168.0.50}
Response (IP_GATEWAY=<gateway_addr>)CrLf	← (IP_GATEWAY=192.168.0.50)

Legend: <gateway_addr>: Four decimal octets separated by dots.

6.4.8. Query the TCP/IP Port

Description: TCP/IP port setting can be queried as follows.

Format	Example1
Command {LW2_PORT=?}	→ {lw2_port=?}
Response (LW2_PORT=<port_nr>)CrLf	← (LW2_PORT=10001)

Explanation: The port number for LW2 protocol is set to 10001 (default value).

Format	Example2
Command {LW3_PORT=?}	→ {lw3_port=?}
Response (LW3_PORT=<port_nr>)CrLf	← (LW3_PORT=6107)

Explanation: The port number for LW3 protocol is set to 6107 (default value).

6.4.9. Set the TCP/IP Port

Description: TCP/IP port setting can be set as follows.

Format	Example1
Command {LW2_PORT=<port_nr>}	→ {lw2_port=10001}
Response (LW2_PORT=<port_nr>)CrLf	← (LW2_PORT=10001)

Explanation: The port number for LW2 protocol is set to 10001 (default value).

Format	Example2
Command {LW3_PORT=<port_nr>}	→ {lw3_port=6107}
Response (LW3_PORT=<port_nr>)CrLf	← (LW3_PORT=6107)

Explanation: The port number for LW3 protocol is set to 6107 (default value).

6.4.10. Query the Status of Ethernet Ports

Description: The Ethernet can be enabled (1) or disabled (0) on each port individually.

Format	Example1
Command {ETH_ENABLE=?}	→ {eth_enable=?}
Response (ETH_ENABLE=<cpu>;<ctrl_tps_link>;<ctrl_lan>;<tps_eth>;<tpsin1_eth>;<tpsin2_eth>;<tpsout1_eth>;<tpsout2_eth>)CrLf	← (ETH_ENABLE=1;1;1;1;1;1;1)

6.4.11. Set the Status of Ethernet Ports

Description: The Ethernet can be enabled (1) or disabled (0) on each port as follows:

Format	Example1
Command {ETH_ENABLE=<cpu>;<ctrl_tps_link>;<ctrl_lan>;<tps_eth>;<tpsin1_eth>;<tpsin2_eth>;<tpsout1_eth>;<tpsout2_eth>}CrLf }	→ {eth_enable=1;1;1;1;1;0;0}
Response (ETH_ENABLE=<cpu>;<ctrl_tps_link>;<ctrl_lan>;<tps_eth>;<tpsin1_eth>;<tpsin2_eth>;<tpsout1_eth>;<tpsout2_eth>)CrLf }	← (ETH_ENABLE=1;1;1;1;1;0;0)

ATTENTION! All ports' status must be defined in the command.

6.5. LW2 Commands – Quick Summary

General LW2 Commands

Operation	See in section	Command
View Product Type	6.2.1	{I}
View Serial Number	6.2.2	{S}
Query Control Protocol	6.2.3	{P_?}
View Firmware Version of the CPU	6.2.4	{F}
Connection Test	6.2.5	{PING}
Compile Time	6.2.6	{CT}
View Installed Board(s)	6.2.7	{IS}
View Firmware for all Controllers'	6.2.8	{FC}
Restart the Matrix Router	6.2.9	{RST}
Query Health Status	6.2.10	{ST}
Restore Factory Default Settings	6.2.11	{FACTORY=ALL}

Port and Crosspoint Settings

Operation	See in section	Command
Switch One Input to One Output	6.3.1	{<in>@<out>}
Mute Specified Output	6.3.2	{#<out>}
Unmute Specified Output	6.3.3	{+<out>}
Lock the Output	6.3.4	{#><out>}
Unlock the Output	6.3.5	{+<<<out>}
View Connection State on the Output	6.3.6	{VC}
View Crosspoint Size	6.3.7	{getsize}
Batch Switch Outputs	6.3.8	{<in>@<out>}{<in>@<out>}
Change the Autoselect Mode	6.3.9	{AS_V<out>=<state>; <mode>}
Change the Video Input Priorities	6.3.10	{PRIO_V<out>=<in1_prio>;<in2_prio>;...;<inn_prio>}

Network Configuration

Operation	See in section	Command
Query the Current IP Status	6.4.1	{IP_STAT=?}
Query the IP Address	6.4.2	{IP_ADDRESS=?}
Set the IP Address	6.4.3	{IP_ADDRESS=<type>;<ip_address>}
Query the Subnet Mask	6.4.4	{IP_NETMASK=?}
Set the Subnet Mask	6.4.5	{IP_NETMASK=<subnet_mask>}
Query the Gateway Address	6.4.6	{IP_GATEWAY=?}
Set the Gateway Address	6.4.7	{IP_GATEWAY=<gateway_addr>}
Query the TCP/IP Port	6.4.8	{LW2_PORT=?} {LW3_PORT=?}
Set the TCP/IP Port	6.4.9	{LW2_PORT=<port_nr> {LW3_PORT=<port_nr>}
Query the Status of Ethernet Ports	6.4.10	{ETH_ENABLE=?}
Set the Status of Ethernet Ports	6.4.11	{ETH_ENABLE=<cpu>; <ctrl_tps_link>;<ctrl_lan>; <tps_eth>;<tpsin1_eth>;<tpsin2_eth>;<tpsout1_eth>; <tpsout2_eth>CrLf }

7

LW3 Programmers' Reference

The device can be controlled through Lightware 3 (LW3) protocol commands to ensure the compatibility with other Lightware products. The supported LW3 commands are described in this chapter.

- ▶ [OVERVIEW](#)
- ▶ [PROTOCOL RULES](#)
- ▶ [SYSTEM COMMANDS](#)
- ▶ [VIDEO PORT AND CROSSPOINT SETTINGS](#)
- ▶ [AUDIO PORT SETTINGS](#)
- ▶ [RS-232 PORT CONFIGURATION](#)
- ▶ [MESSAGE SENDING VIA ETHERNET PORT](#)
- ▶ [MESSAGE SENDING VIA RS-232 SERIAL PORT](#)
- ▶ [INFRARED PORT CONFIGURATION](#)
- ▶ [NETWORK CONFIGURATION](#)
- ▶ [EDID MANAGEMENT](#)
- ▶ [LW3 COMMANDS - QUICK SUMMARY](#)

7.1. Overview

The Lightware Protocol #3 (LW3) is implemented in almost all new Lightware devices (matrix switchers, signal extenders and distribution amplifiers) since 2012. The protocol is ASCII-based and all commands are terminated with a carriage return (Cr, '\r') and line feed (Lf, '\n') pair. It is organized as a tree structure that provides outstanding flexibility and user-friendly handling with 'nodes', 'properties' and 'methods'. The **Advanced View** of the Lightware Device Controller software is the perfect tool for browsing and learning how the LW3 protocol can be used in practice.

7.2. Protocol Rules

7.2.1. LW3 Tree Structure and Command Structure (Examples)

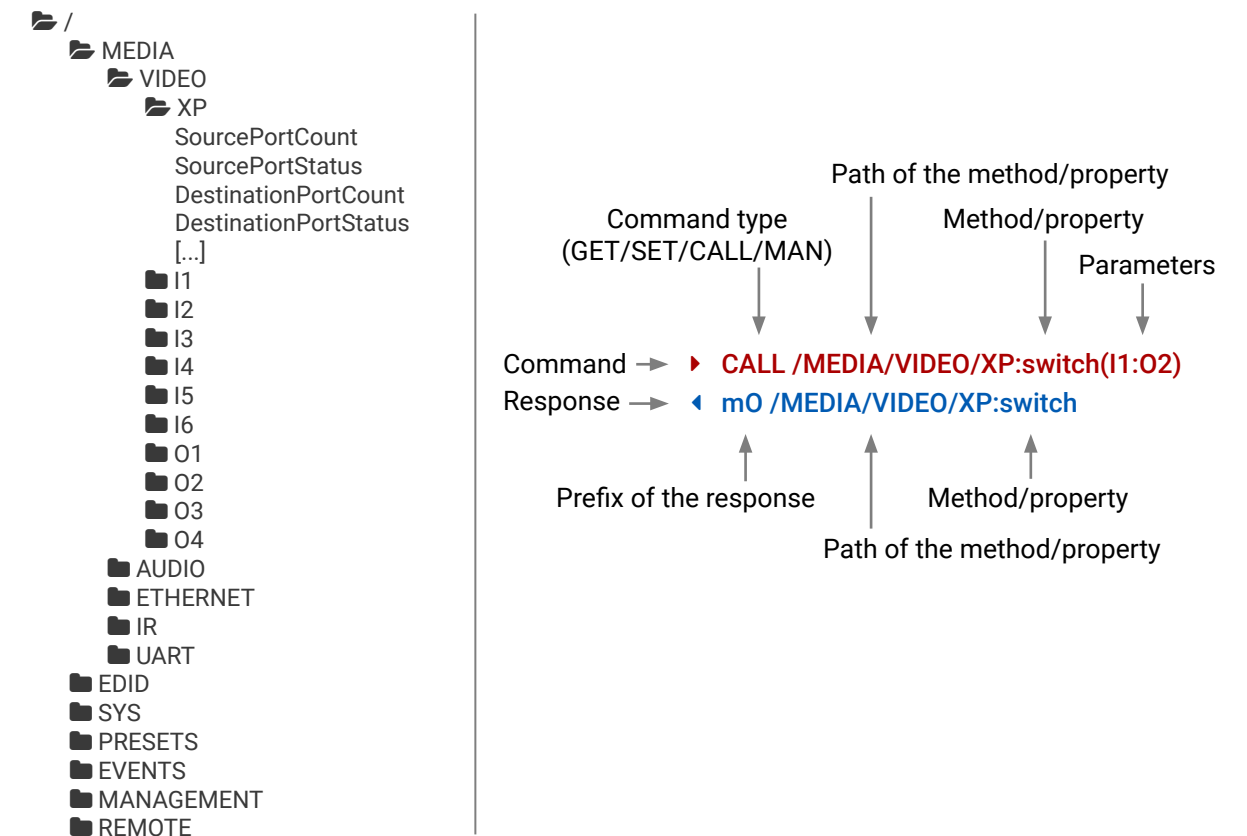

7.2.2. General Rules

- All names and parameters are **case-sensitive**.
- The nodes are separated by a slash ('/') character.
- The node names are comprised of the elements of the English alphabet and numbers.
- Use the **TCP port no. 6107** when using LW3 protocol over Ethernet.
- Node paths describe the exact location of the node, listing each parent node up to the root.

7.2.3. Command Types

GET command

The **GET** command can be used to get the child nodes, properties and methods of a specific node. It can also be used to get the value of a property. Use the dot character (.) when addressing a property:

- ▶ **GET /.SerialNumber**
- ◀ **pr /.SerialNumber=87654321**

GETALL command

The **GETALL** command can be used to get all child nodes, properties and methods of a node with one command.

- ▶ **GETALL /EDID**
- ◀ **n- /EDID/F**
- ◀ **n- /EDID/D**
- ◀ **n- /EDID/U**
- ◀ **n- /EDID/E**
- ◀ **pr /EDID.EdidStatus=F47:E1;F47:E2;F23:E3;F47:E4;F17:E5;F47:E6**
- ◀ **m- /EDID:copy**
- ◀ **m- /EDID:delete**
- ◀ **m- /EDID:reset**
- ◀ **m- /EDID:switch**
- ◀ **m- /EDID:switchAll**

SET command

The **SET** command can be used to modify the value of a property. Use the dot character (.) when addressing the property:

- ▶ **SET /MEDIA/VIDEO/01.HdcpModeSetting=1**
- ◀ **pw /MEDIA/VIDEO/01.HdcpModeSetting=1**

CALL command

A method can be invoked by the **CALL** command. Use the colon character (:) when addressing the method:

- ▶ **CALL /MEDIA/VIDEO/XP:switch(I1:01)**
- ◀ **mO /MEDIA/VIDEO/XP:switch**

MAN command

The manual is a human readable text that describes the syntax and provides a hint for how to use the primitives. For every node, property and method in the tree there is a manual, type the **MAN** command to get the manual:

- ▶ **MAN /MEDIA/VIDEO/01.Pwr5vMode**
- ◀ **pm /MEDIA/VIDEO/01.Pwr5vMode ["0" | "1" | "2"] 0 - Auto, 1 - Always On, 2 - Always Off]**

7.2.4. Prefix Summary

DEFINITION: The prefix is a 2-character long code that describes the type of the response.

The following prefixes are defined in the LW3 protocol:

Prefix	Description	Prefix	Description
n-	a node	pm	a manual for the property
nE	an error for a node	m-	a method
nm	a manual for a node	mO	a response after a success method execution
ns	a child node of a node	mF	a response after a failed method execution
pr	a read-only property	mE	an error for a method
pw	read-write property	mm	a manual for a method
pE	an error for the property		

7.2.5. Error Messages

There are several error messages defined in the LW3 protocol, all of them have a unique error number.

- ▶ **CALL /MEDIA/VIDEO/XP:switch(IA:01)**
- ◀ **mE /MEDIA/VIDEO/XP:switch %E004:Invalid value**

7.2.6. Escaping

DEFINITION: An escape sequence is a sequence of characters that does not represent itself when used inside a character or string literal, but is translated into another character or a sequence of characters.

Property values and method parameters can contain characters that are used as control characters in the protocol. They must be escaped. The escape character is the backslash (\) and escaping means injecting a backslash before the given character (like in C language).

Control characters are the followings: \ { } # % () \r \n \t

A typical usage when a message is sent and it contains such a character that must be escaped.

Example

The original message: `CALL /MEDIA/UART/P1:sendMessage(Set(01))`

The escaped message: `CALL /MEDIA/UART/P1:sendMessage(Set\ (01\))`

The above case is a typical example: the Lightware device is directed to send out a message over one of its port. The round brackets in the message are escaped.

7.2.7. Signature

DEFINITION: The signature is a four-digit-long hexadecimal value that can be optionally placed before every command to keep a command and the corresponding responses together as a group.

Each line is terminated with a carriage return (Cr, '\r') and line feed (Lf, '\n') characters. In several cases the number of the lines in the response cannot be determined in advance, e.g. the client intends to receive for the whole response and also wants to be sure, that the received lines belong together and to the same command. In these cases, a special feature the 'signature' can be used. The response to that particular command will also be preceded by the signature, and the corresponding lines will be between brackets:

```
▶ 1700#GET /EDID.*
◀ {1700
◀ pr /EDID.EdidStatus=F47:E1;F47:E2;F23:E3;F47:E4;F17:E5;F47:E6
◀ m- /EDID:copy
◀ m- /EDID:delete
◀ m- /EDID:reset
◀ m- /EDID:switch
◀ m- /EDID:switchAll
◀ }
```

INFO: The lines of the signature are also Cr and Lf terminated.

7.2.8. Subscription

DEFINITION: Subscription to a node means that the user will get a notification if a property of the node changes.

A user can subscribe to any node. These notifications are asynchronous messages and are useful to keep the client application up to date, without having to periodically poll the node to detect a changed property. When the user does not want to be informed about the changes anymore, he can simply unsubscribe from the node.

ATTENTION! The subscriptions are handled separately for connections. Hence, if the connection is terminated all registered subscriptions are deleted. After reopening a connection all subscribe commands have to be sent in order to get the notifications of the changes on that connection.

Subscribe to a Node

```
▶ OPEN /MEDIA/VIDEO
◀ o- /MEDIA/VIDEO
```

Get the Active Subscriptions

```
▶ OPEN
◀ o- /MEDIA/VIDEO
◀ o- /EDID
◀ o- /DISCOVERY
```

Subscribe to Multiple Nodes

```
▶ OPEN /MEDIA/VIDEO/*
◀ o- /MEDIA/VIDEO/*
```

Unsubscribe from a Node

```
▶ CLOSE /MEDIA/VIDEO
◀ c- /MEDIA/VIDEO
```

Unsubscribe from Multiple Nodes

```
▶ CLOSE /MEDIA/VIDEO/*
◀ c- /MEDIA/VIDEO/*
```

7.2.9. Notifications about the Changes of the Properties

When the value of a property is changed and the user is subscribed to the node, which the property belongs to, an asynchronous notification is generated. This notification is called as the 'change message'. The format of such a message is very similar to the response for the **GET** command:

```
◀ CHG /EDID.EdidStatus=F48:E1
```

A Short Example of How to Use the Subscription

There are two independent users controlling the device through two independent connections (**Connection #1** and **Connection #2**). The events in the rows occur after each other.

```
▶ OPEN /MEDIA/VIDEO/I1
◀ o- /MEDIA/VIDEO/I1
▶ GET /MEDIA/VIDEO/I1.HdcpEnable
◀ pm /MEDIA/VIDEO/I1.HdcpEnable=false
▶ GET /MEDIA/VIDEO/I1.HdcpEnable
◀ pm /MEDIA/VIDEO/I1/HdcpEnable=false
▶ SET /MEDIA/VIDEO/I1.HdcpEnable=true
◀ pw /MEDIA/VIDEO/I1/HdcpEnable=true
◀ CHG /MEDIA/VIDEO/I1/HdcpEnable=true
```

} Connection #1
} Connection #2
→ Connection #1

Explanation: The first user (**Connection #1**) set a subscription to a node. Later the other user (**Connection #2**) made a change, and thanks for the subscription, the first user got a notification about the change.

Legend for the Control Commands

Format	Description
<in>	Input port number
<out>	Output port number
<port>	Input or output port number
<parameter>	Variable, which is defined and described in the command.
<expression>	Batched parameters: the underline means that more expressions or parameters can be placed by using a semicolon, e.g. I2;I4;I5 or F27:E1;F47:E2
▶	Sent command
◀	Received response
•	Space character
	Separator line ("or" character)

7.3. System Commands

7.3.1. Querying the Product Name

ATTENTION! The name of the product is a read-only parameter and cannot be modified.

Command and Response

- ▶ GET /.ProductName
- ◀ pr /.ProductName=<product_name>

Example

- ▶ GET /.ProductName
- ◀ pr /.ProductName=MMX6x2-HT220

7.3.2. Set the Device Label

ATTENTION! The device label can be changed to a custom text which is displayed in many windows of the LDC. This writable parameter is not the same as the ProductName parameter.

The Device Label can be 39 character length and ASCII characters are allowed. Longer names are truncated.

Command and Response

- ▶ SET /MANAGEMENT/UID/DeviceLabel=<custom_name>
- ◀ pw /MANAGEMENT/UID/DeviceLabel=<custom_name>

Example

- ▶ SET /MANAGEMENT/UID.DeviceLabel=MMX_Control_room
- ◀ pw /MANAGEMENT/UID.DeviceLabel=MMX_Control_room

7.3.3. Query the Serial Number

Command and Response

- ▶ GET /.SerialNumber
- ◀ pr /.SerialNumber=<serial_nr>

Example

- ▶ GET /.SerialNumber
- ◀ pr /.SerialNumber=87654321

7.3.4. Set the Background Light of the LCD Screen

Command and Response

- ▶ SET /MANAGEMENT/UI.LcdMenuBackLightMode=<parameter>
- ◀ pw /MANAGEMENT/UI.LcdMenuBackLightMode=<parameter>

Example

- ▶ SET /MANAGEMENT/UI.LcdMenuBackLightMode=0
- ◀ pw /MANAGEMENT/UI.LcdMenuBackLightMode=0

Parameters

Identifier	Parameter description	Value	Explanation
<parameter>	LCD screen background light mode	0	Off
		1	On

7.3.5. Set the Displayed Text on the LCD Screen

Two-line long message can be displayed on the LCD screen.

Command and Response

- ▶ CALL /MANAGEMENT/UI:LcdMenuMessage(<time>; <1stline_text>; <2ndline_text>)
- ◀ mO /MANAGEMENT/UI:LcdMenuMessage

Example

- ▶ CALL /MANAGEMENT/UI:LcdMenuMessage(100;first line; second line)
- ◀ mO /MANAGEMENT/UI:LcdMenuMessage

Parameters

Identifier	Parameter description	Explanation
<time>	Time	The displayed text is shown a definite time (100 means 1 second.)
<1stline_text> <2ndline_text>	Custom text	The displayed text can be 19 character length and ASCII characters are allowed. Longer names are truncated.

7.3.6. Identify the Device

Calling the method results the blinking of the front panel status LEDs for 10 seconds. This feature can be used to help to identify the device itself in the rack shelf.

Command and Response

- ▶ CALL /MANAGEMENT/UI:identifyMe()
- ◀ mO /MANAGEMENT/UI:identifyMe

Example

- ▶ CALL /MANAGEMENT/UI:identifyMe()
- ◀ mO /MANAGEMENT/UI:identifyMe

7.3.7. Resetting the Matrix

The matrix can be restarted – the current connections (LAN, RS-232) will be terminated.

Command and Response

- ▶ CALL /SYS:Reset()
- ◀ mO /SYS:Reset=

Example

- ▶ CALL /SYS:reset()
- ◀ mO /SYS:reset=

7.3.8. Restore the Factory Default Settings

Command and Response

- ▶ CALL /SYS:factoryDefaults()
- ◀ mO /SYS:factoryDefaults=

Example

- ▶ CALL /SYS:factoryDefaults()
- ◀ mO /SYS:factoryDefaults=

Explanation

The device is restarted, current connections are terminated, and the default settings are restored. See the complete list in [Factory Default Settings](#) section.

7.4. Video Port and Crosspoint Settings

7.4.1. Query the Status of Source Port

Command and Response

- ▶ GET•/MEDIA/VIDEO/XP.SourcePortStatus
- ◀ pr•/MEDIA/VIDEO/XP.SourcePortStatus=<l1_state>;<l2_state>;...;<l6_state>

The response contains 5 ASCII characters for each port. The first character indicates the mute/lock state, the next four characters represent a 2-byte HEX code showing the current state of the input ports.

Example

- ▶ GET /MEDIA/VIDEO/XP.SourcePortStatus
- ◀ pr /MEDIA/VIDEO/XP.SourcePortStatus=T00AF;T00AA;T00BF;T00EF;T000A;M00FF

Legend

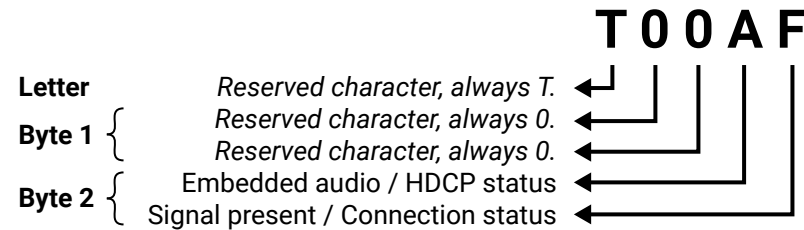

Example and Explanation (for input 1, T00AF)

	Byte 1				Byte 2			
	Character 2		Character 3		Character 4		Character 5	
	BIT 7-6	BIT 5-4	BIT 3-2	BIT 1-0	BIT 7-6	BIT 5-4	BIT 3-2	BIT 1-0
	Reserved	Reserved	Reserved	Reserved	Embedded audio status	HDCP status	Signal present status	Connection status
00	Reserved	Reserved	Reserved	Reserved	Unknown			
01					Reserved			
10					No embedded audio	Not encrypted	No signal	Not connected
11					Embedded audio presents	Encrypted	Signal presents	Connected

T	O		O		A		F	
Reserved	00	00	00	00	10	10	11	11
	Reserved	Reserved	Reserved	Reserved	No embedded audio	Not encrypted	Signal presents	Connected

The Most Common Received Port Status Responses

T00AA	T	O		O		A		A	
	Reserved	00	00	00	00	10	10	10	10
	Reserved	Reserved	Reserved	Reserved	Reserved	No embedded audio	Not encrypted	No signal	Not connected

T00AB	T	O		O		A		B	
	Reserved	00	00	00	00	10	10	10	11
	Reserved	Reserved	Reserved	Reserved	Reserved	No embedded audio	Not encrypted	No signal	Connected

T00AF	T	O		O		A		F	
	Reserved	00	00	00	00	10	10	11	11
	Reserved	Reserved	Reserved	Reserved	Reserved	No embedded audio	Not encrypted	Signal presents	Connected

T00EF	T	O		O		E		F	
	Reserved	00	00	00	00	11	10	11	11
	Reserved	Reserved	Reserved	Reserved	Reserved	Embedded audio presents	Not encrypted	Signal presents	Connected

T00BF	T	O		O		B		F	
	Reserved	00	00	00	00	10	11	11	11
	Reserved	Reserved	Reserved	Reserved	Reserved	No embedded audio	Encrypted	Signal presents	Connected

T00FF	T	O		O		F		F	
	Reserved	00	00	00	00	11	11	11	11
	Reserved	Reserved	Reserved	Reserved	Reserved	Embedded audio presents	Encrypted	Signal presents	Connected

INFO: The settings described in the coming sections depend on the device as the output port numbers are different. Port numbers are listed in section [Input and Output Port Numbering](#).

INFO: The settings of the mirrored outputs are common in most cases. E.g. if the autoselect setting is changed on Output 1, it will be changed on Output 3 as well.

7.4.2. Query the Status of Destination Port

Command and Response

- ▶ GET•/MEDIA/XP/VIDEO.DestinationPortStatus
- ◀ pr•/MEDIA/XP/VIDEO.DestinationPortStatus=<O1_state>;<O2_state>;...;<O4_state>

The response contains 5 ASCII characters for each port. The first character indicates the mute/lock state, the next four characters represent a 2-byte HEX code showing the current state of the input ports.

Example

- ▶ GET /MEDIA/VIDEO/XP.DestinationPortStatus
- ◀ pr /MEDIA/VIDEO/XP.DestinationPortStatus=M00AA;T00AA;T000A;T000A

Legend

See the Legend in [Query the Status of Source Port](#) section.

7.4.3. Query the Video Crosspoint Setting

Command and Response

- ▶ GET•/MEDIA/VIDEO/XP.DestinationConnectionList
- ◀ pr•/MEDIA/VIDEO/XP.DestinationConnectionList=<out_connection>

Example

- ▶ GET /MEDIA/VIDEO/XP.DestinationConnectionList
- ◀ pr /MEDIA/VIDEO/XP.DestinationConnectionList=I1;I3;I1;I3

Explanation

I1 port is connected to O1 and O3, I3 is connected to O2 and O4.

7.4.4. Switching Video Input

Command and Response

- ▶ CALL•/MEDIA/VIDEO/XP:switch(<in>:<out>)
- ◀ mO•/MEDIA/VIDEO/XP:switch

Example

- ▶ CALL /MEDIA/VIDEO/XP:switch(I4:O1)
- ◀ mO /MEDIA/VIDEO/XP:switch

Explanation

I4 port is connected to O1 port.

7.4.5. HDCP Setting (Input Port)

HDCP capability can be enabled/disabled on the input ports, thus, non-encrypted content can be seen on a non-HDCP compliant display. See more information in [HDCP Management](#) section.

Command and Response

- ▶ SET•/MEDIA/VIDEO/<In>.HdcpEnable=<logical_value>
- ◀ pw•/MEDIA/VIDEO/<In>.HdcpEnable=<logical_value>

Parameters

The <logical_value> can be set to **true** or **false**.

Example

- ▶ SET /MEDIA/VIDEO/I1.HdcpEnable=false
- ◀ pw /MEDIA/VIDEO/I1.HdcpEnable=false

7.4.6. HDCP Setting (Output Port)

HDCP capability can be set to Auto/Always on the output ports, thus, non-encrypted content can be transmitted to a non-HDCP compliant display. See more information in [HDCP Management](#) section.

Command and Response

- ▶ SET•/MEDIA/VIDEO/<out>.HdcpModeSetting=<parameter>
- ◀ pw•/MEDIA/VIDEO/<out>.HdcpModeSetting=<parameter>

Parameters

Identifier	Parameter description	Value	Explanation
<parameter>	HDCP mode	0	Auto
		1	Always

Example

- ▶ SET /MEDIA/VIDEO/O1.HdcpModeSetting=0
- ◀ pw /MEDIA/VIDEO/O1.HdcpModeSetting=0

7.4.7. Query the Video Autoselect Settings

Command and Response

- ▶ GET•/MEDIA/VIDEO/XP.DestinationPortAutoselect
- ◀ pr•/MEDIA/VIDEO/XP.DestinationPortAutoselect=<out_set>

The response shows the settings of each output one by one.

Legend

<out_set> Two-letter code of the Autoselect settings.

Parameters

Identifier	Parameter description	Value	Explanation
<out_set> - 1 st letter	Autoselect enabling/ disabling	E	Autoselect is enabled .
		D	Autoselect is disabled .
<out_set> - 2 nd letter	Autoselect mode	F	First detect mode: the first active video input is selected.
		P	Priority detect: always the highest priority active video input will be selected.
		L	Last detect: always the last attached input is switched to the output automatically.

Example

- ▶ GET /MEDIA/VIDEO/XP.DestinationPortAutoselect
- ◀ pr /MEDIA/VIDEO/XP.DestinationPortAutoselect=EL;DP;EL;DP

Explanation

EL: the Autoselect is **Enabled** on output 1 and output 3, selected mode is Last detect.

DP: the Autoselect is **Disabled** on output 2 and output 4.

INFO: For more information see [The Autoselect Feature](#) section.

7.4.8. Change the Autoselect Mode

Command and Response

- ▶ CALL•/MEDIA/VIDEO/XP:setDestinationPortAutoselect(<On>:<On_set>)
- ◀ mO•/MEDIA/VIDEO/XP:setDestinationPortAutoselect

Legend

See the previous section.

Example

- ▶ CALL /MEDIA/VIDEO/XP:setDestinationPortAutoselect(O1:EF)
- ◀ mO /MEDIA/VIDEO/XP:setDestinationPortAutoselect

Explanation

The Autoselect mode is Enabled on Output 1 in First detect mode.

7.4.9. Query the Input Port Priority

Command and Response

- ▶ GET•/MEDIA/VIDEO/XP.PortPriorityList
- ◀ pr•/MEDIA/VIDEO/XP.PortPriorityList=<out_list>

The response shows the priority of each output one after another. The priority number can be from 0 to 31; 0 is the highest- and 30 is the lowest priority. 31 means that the port will be skipped from the priority list.

Legend

<out_list>: The input port priority order of the given output port: <l1>,<l2>,...,<lm>

Example

- ▶ GET /MEDIA/VIDEO/XP.PortPriorityList
- ◀ pr /MEDIA/VIDEO/XP.PortPriorityList= 5,4,3,2,1,0;0,1,2,3,4,5; 5,4,3,2,1,0;0,1,2,3,4,5

Explanation

There are four outputs, so there are four groups listed in the response (divided by semicolons) and each group (list) contains six priority numbers. The priority list of O1 and O3 is common, such as the list of O2 and O4.

The response: 5,4,3,2,1,0;0,1,2,3,4,5;5,4,3,2,1,0;0,1,2,3,4,5. Those values show the priority order of the video input ports:

Output 1						Output 2						Output 3						Output 4					
11	12	13	14	15	16	11	12	13	14	15	16	11	12	13	14	15	16	11	12	13	14	15	16
5	4	3	2	1	0	0	1	2	3	4	5	5	4	3	2	1	0	0	1	2	3	4	5

In the above example, the Input 6 has the highest priority on O1 and O3 output ports and Input 1 has the lowest priority. On O2 and O4 ports the setting is the opposite.

ATTENTION! The same priority number can be set to different input ports. When the priority numbers match, the input port with the lowest port number will have the highest priority.

7.4.10. Changing the Input Port Priority

Command and Response

- ▶ CALL•/MEDIA/VIDEO/XP:setAutoselectionPriority(<in>(<out>):<prio>)
- ◀ mO•/MEDIA/VIDEO/XP:setAutoselectionPriority

Legend

Identifier	Parameter description
<prio>	Priority number from 0 to 31, equal numbers are allowed (31 means that the port will be skipped from the priority list).

An input port priority can be set on an output port. Many settings can be executed by separating a semicolon (no space), see the example below.

Example

- ▶ CALL /MEDIA/VIDEO/XP:setAutoselectionPriority (I1(O1):31;I2(O1):1;I3(O1):2;I4(O1):3;I5(O1):4;I6(O1):5)
- ◀ mO /MEDIA/VIDEO/XP:setAutoselectionPriority

Explanation

The Input 1 is ignored from the autoselection, priority order of the inputs are: I2, I3, I4, I5, I6.

7.4.11. Mute Input Port

Command and Response

- ▶ CALL•/MEDIA/VIDEO/XP:muteSource(<in>)
- ◀ mO•/MEDIA/VIDEO/XP:muteSource

Example

- ▶ CALL /MEDIA/VIDEO/XP:muteSource(I1)
- ◀ mO /MEDIA/VIDEO/XP:muteSource

7.4.12. Unmute Input Port

Command and Response

- ▶ CALL•/MEDIA/VIDEO/XP:unmuteSource(<in>)
- ◀ mO•/MEDIA/VIDEO/XP:unmuteSource

Example

- ▶ CALL /MEDIA/VIDEO/XP:unmuteSource(I1)
- ◀ mO /MEDIA/VIDEO/XP:unmuteSource

7.4.13. Lock Input Port

Command and Response

- ▶ CALL•/MEDIA/VIDEO/XP:lockSource(<in>)
- ◀ mO•/MEDIA/VIDEO/XP:lockSource

Example

- ▶ CALL /MEDIA/VIDEO/XP:lockSource(I1)
- ◀ mO /MEDIA/VIDEO/XP:lockSource

7.4.14. Unlock Input Port

Command and Response

- ▶ CALL•/MEDIA/VIDEO/XP:unlockSource(<in>)
- ◀ mO•/MEDIA/VIDEO/XP:unlockSource

Example

- ▶ CALL /MEDIA/VIDEO/XP:unlockSource(I1)
- ◀ mO /MEDIA/VIDEO/XP:unlockSource

7.4.15. Mute Output Port

Command format

- ▶ CALL•/MEDIA/VIDEO/XP:muteDestination(<out>)
- ◀ mO•/MEDIA/VIDEO/XP:muteDestination

Example

- ▶ CALL /MEDIA/VIDEO/XP:muteDestination(O1)
- ◀ mO /MEDIA/VIDEO/XP:muteDestination

7.4.16. Unmute Output Port

Command format

- ▶ CALL•/MEDIA/VIDEO/XP:unmuteDestination(<out>)
- ◀ mO•/MEDIA/VIDEO/XP:unmuteDestination

Example

- ▶ CALL /MEDIA/VIDEO/XP:unmuteDestination(O1)
- ◀ mO /MEDIA/VIDEO/XP:unmuteDestination

7.4.17. Lock Output Port

Command format

- ▶ CALL•/MEDIA/VIDEO/XP:lockDestination(<out>)
- ◀ mO•/MEDIA/VIDEO/XP:lockDestination

Example

- ▶ CALL /MEDIA/VIDEO/XP:lockDestination(O1)
- ◀ mO /MEDIA/VIDEO/XP:lockDestination

7.4.18. Unlock Input Port

Command format

- ▶ CALL•/MEDIA/VIDEO/XP:unlockDestination(<out>)
- ◀ mO•/MEDIA/VIDEO/XP:unlockDestination

Example

- ▶ CALL /MEDIA/VIDEO/XP:unlockDestination(O1)
- ◀ mO /MEDIA/VIDEO/XP:unlockDestination

7.4.19. Test Pattern Generator - Mode

The output ports can send a special image towards the sink devices for testing purposes. The setting is available on output ports with the below-listed parameters.

ATTENTION! The Mode can be set individually on each port, but the Clock source and the Pattern settings are common on the mirrored output ports (e.g. on O1 and O3 output ports).

Command and Response

- ▶ SET•/MEDIA/VIDEO/<out>.TpgMode=<mode>
- ◀ pw•/MEDIA/VIDEO/<out>.TpgMode=<mode>

Parameters

Identifier	Parameter description	Value	Explanation
		0	The test pattern is not displayed on the output.
<mode>	Test pattern mode setting	1	The test pattern is displayed if there is no video is received on the output port.
		2	The test pattern is displayed on the output even there is an incoming signal.

Example

- ▶ SET /MEDIA/VIDEO/O1.TpgMode=2
- ◀ pw /MEDIA/VIDEO/O1.TpgMode=2

7.4.20. Test Pattern Generator - Clock Source

Command and Response

- ▶ SET•/MEDIA/VIDEO/<On>.TpgClockSource=<clock_source>
- ◀ pw•/MEDIA/VIDEO/<On>.TpgClockSource=<clock_source>

Parameters

Identifier	Parameter description	Value	Explanation
		480	480p
<clock_source>	Test pattern clock source frequency	576	576p
		EXT	External clock (from actual TMDS source)

Example

- ▶ SET /MEDIA/VIDEO/O1.TpgClockSource=576
- ◀ pw /MEDIA/VIDEO/O1.TpgClockSource=576

7.4.21. Test Pattern Generator - Pattern setting

Command and Response

- ▶ SET•/MEDIA/VIDEO/<On>.TpgPattern=<pattern>
- ◀ pw•/MEDIA/VIDEO/<On>.TpgPattern=<pattern>

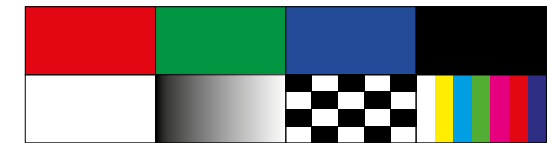

Parameters

Identifier	Parameter description	Value	Explanation
		RED	Red pattern
		GREEN	Green pattern
		BLUE	Blue pattern
		BLACK	Black pattern
<pattern>	Test pattern	WHITE	White pattern
		RAMP	Black to white ramp pattern
		CHESS	Chess table pattern
		BAR	Color bars pattern
		CYCLE	All the patterns are changed sequentially approx. in every 2 seconds

Example

- ▶ SET /MEDIA/VIDEO/O1.TpgPattern=GREEN
- ◀ pw /MEDIA/VIDEO/O1.TpgPattern=GREEN

7.4.22. Query the Current TPS Mode

Command and Response

- ▶ GET•/REMOTE/<source>|<destination>.tpsMode
- ◀ pr•/REMOTE/<source>|<destination>.tpsMode=<TPS_mode>

Parameters

Identifier	Parameter description	Value	Explanation
<source>	TPS input ports	S1	TPS in 1
		S2	TPS in 2
<destination>	TPS output ports	D1	TPS out 1
		D2	TPS out 2
<TPS_mode>	HDBaseT working mode	A	Auto
		H	HDBaseT
		L	Long reach
		1	LPPF1
		2	LPPF2

For more information about TPS modes see [TPS Working Modes](#) section.

Example

- ▶ GET /REMOTE/S1.tpsMode
- ◀ pr /REMOTE/S1.tpsMode=A

7.4.23. TPS Mode Setting on TPS Ports

Command and Response

- ▶ SET•/REMOTE/<source>|<destination>.tpsModeSetting=<TPS_mode>
- ◀ pw•/REMOTE/<source>|<destination>.tpsModeSetting=<TPS_mode>

Example

- ▶ SET /REMOTE/S1.tpsModeSetting=L
- ◀ pw /REMOTE/S1.tpsModeSetting=L

Parameters

See the previous section.

7.4.24. HDMI Mode Settings (Output Ports)

Command and Response

- ▶ SET•/MEDIA/VIDEO/<out>.HdmiModeSetting=<HDMI_mode>
- ◀ pw•/MEDIA/VIDEO/<out>.HdmiModeSetting=<HDMI_mode>

Parameters

Identifier	Parameter description	Value	Explanation
<HDMI_mode>	HDMI mode	0	Auto
		1	DVI
		2	HDMI

Example

- ▶ SET /MEDIA/VIDEO/O1.HdmiModeSetting=2
- ◀ pw /MEDIA/VIDEO/O1.HdmiModeSetting=2

7.5. Audio Port Settings

7.5.1. Signal Source Selection

Command and Response

- ▶ SET•/MEDIA/VIDEO/<in>|<out>.AudioMode=<audio_mode>
- ◀ pw•/MEDIA/VIDEO/<in>|<out>.AudioMode=<audio_mode>

Parameters

Identifier	Parameter description	Value	Explanation
<audio_mode>	Audio signal source mode	0	Embedded
		1	AUX1
		2	AUX2
		3	AUX3
		4	AUX4

INFO: For more information about the audio, capabilities see [Audio Inputs and Modes](#) section

INFO: The setting is common on the mirrored outputs and available on the HDMI output ports.

Example

- ▶ SET /MEDIA/VIDEO/I1.AudioMode=1
- ◀ pw /MEDIA/VIDEO/I1.AudioMode=1

7.5.2. Analog Audio Input Level Settings - Volume

INFO: The following setting is valid only for analog audio input ports.

Command and Response

- ▶ SET•/MEDIA/AUDIO/<in>.Volume=<volume>
- ◀ pw•/MEDIA/AUDIO/<in>.Volume=<volume>

Parameters

Identifier	Parameter description
<volume>	Sets the input volume (attenuation) between -95.625 dB and 0 dB in step of -0.375 dB. The value is rounded up if necessary to match with the step value.

Example

- ▶ SET /MEDIA/AUDIO/I7.Volume=-15
- ◀ pw /MEDIA/AUDIO/I7.Volume=-15.000

7.5.3. Analog Audio Input Level Settings - Balance

INFO: The following setting is valid only for analog audio input ports.

Command and Response

- ▶ SET•/MEDIA/AUDIO/<in>.Balance=<balance>
- ◀ pw•/MEDIA/AUDIO/<in>.Balance=<balance>

Parameters

Identifier	Parameter description
<balance>	Sets the balance; 0 means left balance, 100 means right balance, step is 1. Center is 50 (default).

Example

- ▶ SET /MEDIA/AUDIO/I7.Balance=25
- ◀ pw /MEDIA/AUDIO/I7.Balance=25

7.5.4. Analog Audio Input Level Settings - Gain

INFO: The following setting is valid only for analog audio input ports.

Command and Response

- ▶ SET•/MEDIA/AUDIO/<in>.Gain=<gain>
- ◀ pw•/MEDIA/AUDIO/<in>.Gain=<gain>

Parameters

Identifier	Parameter description
<gain>	Sets the input gain between 0 dB and 21 dB in step of 0.75 dB. The value is rounded down if necessary to match the step value.

Example

- ▶ SET /MEDIA/AUDIO/I7.Gain=4
- ◀ pw /MEDIA/AUDIO/I7.Gain=3.75

7.5.5. Analog Audio Output Level Settings - Volume

INFO: The following setting is valid only for analog audio output ports.

Command and Response

- ▶ SET•/MEDIA/AUDIO/<out>.Volume=<volume>
- ◀ pw•/MEDIA/AUDIO/<out>.Volume=<volume>

Parameters

Identifier	Parameter description
<volume>	Sets the output volume (attenuation) between 0dB and -57 dB in step of -1 dB. The value is rounded up if necessary to match with the step value.

Example

- ▶ SET /MEDIA/AUDIO/I7.Volume=-8
- ◀ pw /MEDIA/AUDIO/I7.Volume=-8

7.5.6. Analog Audio Output Level Settings - Balance

INFO: The following setting is valid only for analog audio output ports.

Command and Response

- ▶ SET•/MEDIA/AUDIO/<in>.Balance=<balance>
- ◀ pw•/MEDIA/AUDIO/<in>.Balance=<balance>

Parameters

Identifier	Parameter description
<balance>	Sets the balance; 0 means left balance, 100 means right balance, step is 1. Center is 50 (default).

Example

- ▶ SET /MEDIA/AUDIO/O5.Balance=0
- ◀ pw /MEDIA/AUDIO/O5.Balance=0

7.5.7. Analog Audio Output Level Settings - Gain

INFO: The following setting is valid only for analog audio output ports.

Command and Response

- ▶ SET•/MEDIA/AUDIO/<out>.Gain=<gain>
- ◀ pw•/MEDIA/AUDIO/<out>.Gain=<gain>

Parameters

Identifier	Parameter description
<gain>	Sets the output gain which can be 0, 1, 2 or 3 dB. The value is rounded down if necessary to match with the step value.

Example

- ▶ SET /MEDIA/AUDIO/O5.Gain=2
- ◀ pw /MEDIA/AUDIO/O5.Gain=2

7.5.8. Analog Audio Output Level Settings - Mute / Unmute

INFO: The following setting is valid only for analog audio output ports.

Command and Response

- ▶ SET•/MEDIA/AUDIO/<out>.MuteSetting=<logical_value>
- ◀ pw•/MEDIA/AUDIO/<out>.MuteSetting=<logical_value>

Parameters

Identifier	Parameter description	Value	Explanation
<logical_value>	Mute setting	true	The port is muted.
		false	The port is unmuted.

Example

- ▶ SET /MEDIA/AUDIO/O5.MuteSetting=true
- ◀ pw /MEDIA/AUDIO/O5.MuteSetting=true

7.6. RS-232 Port Configuration

ATTENTION! MMX6x2 handles many serial ports. The following parameters can be set individually on each port; the exact port numbering is listed in section [Factory Default Settings](#).

7.6.1. Protocol Setting

Command and Response

- ▶ SET•/MEDIA/UART/<port>.ControlProtocol=<number>
- ◀ pw•/MEDIA/UART/<port>.ControlProtocol=<number>

Parameters

Identifier	Parameter description	Value	Explanation
<number>	Control protocol	0	LW2
		1	LW3

Example

- ▶ SET /MEDIA/UART/P1.ControlProtocol=1
- ◀ pw /MEDIA/UART/P1.ControlProtocol=1

7.6.2. BAUD Rate Setting

Command and Response

- ▶ SET•/MEDIA/UART/<port>.Baudrate=<number>
- ◀ pw•/MEDIA/UART/<port>.Baudrate=<number>

Parameters

Identifier	Parameter description	Value	Explanation
		0	4800
		1	7200
		2	9600
		3	14400
<number>	Baud rate value	4	19200
		5	38400
		6	57600
		7	115200

Example

- ▶ SET /MEDIA/UART/P1.Baudrate=2
- ◀ pw /MEDIA/UART/P1.Baudrate=2

7.6.3. Databits Setting

Command and Response

- ▶ SET•/MEDIA/UART/<port>.DataBits=<databits>
- ◀ pw•/MEDIA/UART/<port>.DataBits=<databits>

Parameters

Identifier	Parameter description	Value	Explanation
<databits>	Data bits value	8	8 data bits
		9	9 data bits

Example

- ▶ SET /MEDIA/UART/P1.DataBits=8
- ◀ pw /MEDIA/UART/P1.DataBits=8

7.6.4. Stopbits Setting

Command and Response

- ▶ SET•/MEDIA/UART/<port>.StopBits=<number>
- ◀ pw•/MEDIA/UART/<port>.StopBits=<number>

Parameters

Identifier	Parameter description	Value	Explanation
		0	1
<number>	Stop bits value	1	1,5
		2	2

Example

- ▶ SET /MEDIA/UART/P1.StopBits=0
- ◀ pw /MEDIA/UART/P1.StopBits=0

7.6.5. Parity Setting

Command and Response

- ▶ SET•/MEDIA/UART/<port>.Parity=<number>
- ◀ pw•/MEDIA/UART/<port>.Parity=<number>

Parameters

Identifier	Parameter description	Value	Explanation
		0	None
<number>	Parity value	1	Odd
		2	Even

Example

- ▶ SET /MEDIA/UART/P1.Parity=0
- ◀ pw /MEDIA/UART/P1.Parity=0

7.6.6. RS-232 Operation Mode

Command format

- ▶ SET•/MEDIA/UART/<port>.Rs232Mode=<number>
- ◀ pw•/MEDIA/UART/<port>.Rs232Mode=<number>

Parameters

Identifier	Parameter description	Value	Explanation
		0	Disconnect
<number>	RS-232 operation mode	1	Control
		2	Command injection

Example

- ▶ SET /MEDIA/UART/P2.Rs232Mode=1
- ◀ pw /MEDIA/UART/P2.Rs232Mode=1

7.6.7. Command Injection Mode

Command format

- ▶ SET•/MEDIA/UART/<port>.CommandInjectionEnable=<logical_value>
- ◀ pw•/MEDIA/UART/<port>.CommandInjectionEnable=<logical_value>

Parameters

Identifier	Parameter description	Value	Explanation
<logical_value>	Command injection status	true	Command injection is enabled on the port.
		false	Command injection is disabled on the port.

Example

- ▶ SET /MEDIA/UART/P2.CommandInjectionEnable=true
- ◀ pw /MEDIA/UART/P2.CommandInjectionEnable=true

ATTENTION! The Command injection status is stored in another read-only property which is True if both above mentioned properties are set to the proper state; if so, Command injection mode is active: /MEDIA/UART/<Pn>.CommandInjectionStatus.

ATTENTION! Do not forget to set the TCP/IP port setting which is individual for each RS-232 port and stored in /MEDIA/UART/<Pn>.CommandInjectionPort parameter.

7.7. Message Sending via Ethernet Port

7.7.1. Sending a TCP Message (ASCII-format) via Ethernet

The command is for sending a command message in ASCII-format. This method **allows** escaping the control characters, see the [Escaping](#) section.

Command and Response

- ▶ CALL•/MEDIA/ETHERNET:tcpMessage(<IP_address>:<port_no>=<message>)
- ◀ mO•/MEDIA/ETHERNET:tcpMessage

Example

- ▶ CALL /MEDIA/ETHERNET:tcpMessage(192.168.0.20:5555=C00)
- ◀ mO /MEDIA/ETHERNET:tcpMessage

The 'C00' message is sent to the indicated IP:port address.

Example with HEX codes

- ▶ CALL /MEDIA/ETHERNET:tcpMessage(192.168.0.20:5555=C00\x0a\x0d)
- ◀ mO /MEDIA/ETHERNET:tcpMessage

The 'C00' message with CrLf (Carriage return and Line feed) is sent to the indicated IP:port address. The \x sequence indicates the HEXA code.

Escaping in the Message

When commands need to be separated by <CR><LF> characters to be recognized by the controlled device, then they need to be escaped. You can use the following format for escaping:

<command1><\x0d\x0a><command2><\x0d\x0a>...<commandn><\x0d\x0a>

7.7.2. Sending a TCP Text (ASCII-format) via Ethernet

The command is for sending a text message in ASCII-format. This method **does not allow** escaping or inserting control characters.

Command and Response

- ▶ CALL•/MEDIA/ETHERNET:tcpText(<IP_address>:<port_no>=<text>)
- ◀ mO•/MEDIA/ETHERNET:tcpText

Example

- ▶ CALL /MEDIA/ETHERNET:tcpText(192.168.0.20:5555=open)
- ◀ mO /MEDIA/ETHERNET:tcpText

The 'open' text is sent to the indicated IP:port address.

7.7.3. Sending a TCP Binary Message (HEX-format) via Ethernet

The command is for sending a binary message in Hexadecimal format. This method **does not allow** escaping or inserting control characters.

Command and Response

- ▶ CALL•/MEDIA/ETHERNET:tcpBinary(<IP_address>:<port_no>=<HEX_message>)
- ◀ mO•/MEDIA/ETHERNET:tcpBinary

Example

- ▶ CALL /MEDIA/ETHERNET:tcpBinary(192.168.0.20:5555=433030)
- ◀ mO /MEDIA/ETHERNET:tcpBinary

The '433030' message is sent to the indicated IP:port address.

INFO: There is no need to insert a space or other separator character between the binary messages.

7.7.4. Sending a UDP Message (ASCII-format) via Ethernet

The command is for sending a UDP message in ASCII-format. This method **allows** escaping the control characters, see the [Escaping](#) section.

Command and Response

- ▶ CALL•/MEDIA/ETHERNET:udpMessage(<IP_address>:<port_no>=<message>)
- ◀ mO•/MEDIA/ETHERNET:udpMessage

Example

- ▶ CALL /MEDIA/ETHERNET:udpMessage(192.168.0.20:9988=C00)
- ◀ mO /MEDIA/ETHERNET:udpMessage

The 'C00' message is sent to the indicated IP:port address.

Example with HEX codes

- ▶ CALL /MEDIA/ETHERNET:udpMessage(192.168.0.20:9988=C00\x0a\x0d)
- ◀ mO /MEDIA/ETHERNET:udpMessage

The 'C00' message with CrLf (Carriage return and Line feed) is sent to the indicated IP:port address. The \x sequence indicates the HEXA code.

Escaping in the Message

When commands need to be separated by <CR><LF> characters to be recognized by the controlled device, then they need to be escaped. You can use the following format for escaping:

<command₁><\x0d\x0a><command₂><\x0d\x0a>...<command_n><\x0d\x0a>

7.7.5. Sending a TCP Text (ASCII-format) via Ethernet

The command is for sending a text message in ASCII-format via UDP-protocol. This method **does not allow** escaping or inserting control characters.

Command and Response

- ▶ CALL•/MEDIA/ETHERNET:udpText(<IP_address>:<port_no>=<text>)
- ◀ mO•/MEDIA/ETHERNET:udpText

Example

- ▶ CALL /MEDIA/ETHERNET:udpText(192.168.0.20:9988=open)
- ◀ mO /MEDIA/ETHERNET:udpText

The 'open' text is sent to the indicated IP:port address.

7.7.6. Sending a UDP Binary Message (HEX-format) via Ethernet

The command is for sending a binary message in Hexadecimal format via UDP protocol. This method **does not allow** escaping or inserting control characters.

Command and Response

- ▶ CALL•/MEDIA/ETHERNET:udpBinary(<IP_address>:<port_no>=<HEX_message>)
- ◀ mO•/MEDIA/ETHERNET:udpBinary

Example

- ▶ CALL /MEDIA/ETHERNET:udpBinary(192.168.0.20:9988=433030)
- ◀ mO /MEDIA/ETHERNET:udpBinary

The '433030' message is sent to the indicated IP:port address.

■ INFO: There is no need to insert a space or other separator character between the binary messages.

7.8. Message Sending via RS-232 Serial Port

7.8.1. Sending a Text (ASCII-format) via Serial Port

The command is for sending a command message in ASCII-format. This method **does not allow** escaping the control characters.

Command and Response

- ▶ CALL•/MEDIA/UART/<port>:sendText(<message>)
- ◀ mO•/MEDIA/UART/<port>:sendText

Example

- ▶ CALL /MEDIA/UART/P1:sendText(open)
- ◀ mO /MEDIA/UART/P1:sendText

The 'open' text is sent out via the P1 serial port.

7.8.2. Sending a Binary Message (HEX-format) via Serial Port

The command is for sending a command message in Hexadecimal-format. This method **does not allow** escaping the control characters.

Command and Response

- ▶ CALL•/MEDIA/UART/<port>:sendBinaryMessage(<message>)
- ◀ mO•/MEDIA/UART/<port>:sendBinaryMessage

Example

- ▶ CALL /MEDIA/UART/P1:sendBinaryMessage(433030)
- ◀ mO /MEDIA/UART/P1:sendBinaryMessage

The '433030' message is sent out via the P1 serial port.

7.8.3. Sending a Message (ASCII-format) via Serial Port

The command is for sending a command message in ASCII-format. This method **allows** escaping the control characters, see the [Escaping](#) section.

Command and Response

- ▶ CALL•/MEDIA/UART/<port>:sendMessage(<message>)
- ◀ mO•/MEDIA/UART/<port>:sendMessage

Example

- ▶ CALL /MEDIA/UART/P1:sendMessage(PWR0)
- ◀ mO /MEDIA/UART/P1:sendMessage

The 'PWR0' message is sent out via the P1 serial port.

Escaping in the Message

When commands need to be separated by <CR><LF> characters to be recognized by the controlled device, then they need to be escaped. You can use the following format for escaping:

`<command1><\x0d\x0a><command2><\x0d\x0a>...<commandn><\x0d\x0a>`

7.9. Infrared Port Configuration

INFO: Infrared port numbering can be found in the [Input and Output Port Numbering](#) section.

7.9.1. Enable Command Injection Mode

Command and Response

- ▶ SET•/MEDIA/IR/<source>|<destination>.CommandInjectionEnable=<logical_value>
- ◀ pw•/MEDIA/IR/<source>|<destination>.CommandInjectionEnable=<logical_value>

Parameters

Identifier	Parameter description	Value	Explanation
<source>	Infrared TPS input ports	S1 - S4	Infrared TPS input ports
<destination>	Infrared TPS output ports	D1 - D4	Infrared TPS output ports
<logical_value>	Command injection status	true	Command injection is enabled on the port.
		false	Command injection is disabled on the port.

Example

- ▶ SET /MEDIA/IR/S1.CommandInjectionEnable=true
- ◀ pw /MEDIA/IR/S1.CommandInjectionEnable=true

7.9.2. Enable/Disable Output Signal Modulation

Command and Response

- ▶ SET•/MEDIA/IR/<destination>.EnableModulation=<logical_value>
- ◀ pw•/MEDIA/IR/<destination>.EnableModulation=<logical_value>

Parameters

Identifier	Parameter description	Value	Explanation
<logical_value>	Signal modulation status	true	Signal modulation is enabled on the port.
		false	Signal modulation is disabled on the port.

Example

- ▶ SET /MEDIA/IR/D2.EnableModulation=false
- ◀ pw /MEDIA/IR/D2.EnableModulation=false

INFO: The default setting value is "true" (enabled).

7.9.3. Change Command Injection Port Number

Command and Response

- ▶ SET•/MEDIA/IR/<source>|<destination>.CommandInjectionPort=<port_no>
- ◀ pw•/MEDIA/IR/<source>|<destination>.CommandInjectionPort=<port_no>

Example

- ▶ SET /MEDIA/IR/S1.CommandInjectionPort=9001
- ◀ pw /MEDIA/IR/S1.CommandInjectionPort=9001

7.10. Network Configuration

7.10.1. Query the DHCP State

Command and Response

- ▶ GET•/MANAGEMENT/NETWORK.DhcpEnabled
- ◀ pw•/MANAGEMENT/NETWORK.DhcpEnabled=<logical_value>

Parameters

Identifier	Parameter description	Value	Explanation
<logical_value>	Dynamic IP address (DHCP) status	true	DHCP is enabled.
		false	DHCP is disabled.

Example

- ▶ GET /MANAGEMENT/NETWORK.DhcpEnabled
- ◀ pw /MANAGEMENT/NETWORK.DhcpEnabled=true

7.10.2. Change the DHCP State

Command and Response

- ▶ SET•/MANAGEMENT/NETWORK.DhcpEnabled=<logical_value>
- ◀ pw•/MANAGEMENT/NETWORK.DhcpEnabled=<logical_value>

Parameters

See the previous section.

Example

- ▶ SET /MANAGEMENT/NETWORK.DhcpEnabled=true
- ◀ pw /MANAGEMENT/NETWORK.DhcpEnabled=true

7.10.3. Query the IP Address

Command and Response

- ▶ GET•/MANAGEMENT/NETWORK.IpAddress
- ◀ pr•/MANAGEMENT/NETWORK.IpAddress=<IP_address>

Example

- ▶ GET /MANAGEMENT/NETWORK.IpAddress
- ◀ pr /MANAGEMENT/NETWORK.IpAddress=192.168.0.102

7.10.4. Change the IP Address (Static)

Command and Response

- ▶ SET•/MANAGEMENT/NETWORK.StaticIpAddress=<IP_address>
- ◀ pw•/MANAGEMENT/NETWORK.StaticIpAddress=<IP_address>

Example

- ▶ SET /MANAGEMENT/NETWORK.StaticIpAddress=192.168.0.105
- ◀ pw /MANAGEMENT/NETWORK.StaticIpAddress=192.168.0.105

7.10.5. Query the Subnet Mask

Command and Response

- ▶ GET•/MANAGEMENT/NETWORK.NetworkMask
- ◀ pr•/MANAGEMENT/NETWORK.NetworkMask=<netmask>

Example

- ▶ GET /MANAGEMENT/NETWORK.NetworkMask
- ◀ pr /MANAGEMENT/NETWORK.NetworkMask=255.255.255.0

7.10.6. Change the Subnet Mask (Static)

Command and Response

- ▶ SET•/MANAGEMENT/NETWORK.StaticNetworkMask=<netmask>
- ◀ pw•/MANAGEMENT/NETWORK.StaticNetworkMask=<netmask>

Example

- ▶ SET /MANAGEMENT/NETWORK.StaticNetworkMask=255.255.255.0
- ◀ pw /MANAGEMENT/NETWORK.StaticNetworkMask=255.255.255.0

7.10.7. Query the Gateway Address

Command and Response

- ▶ GET•/MANAGEMENT/NETWORK.GatewayAddress
- ◀ pr•/MANAGEMENT/NETWORK.GatewayAddress=<gw_address>

Example

- ▶ GET /MANAGEMENT/NETWORK.GatewayAddress
- ◀ pr /MANAGEMENT/NETWORK.GatewayAddress=192.168.0.1

7.10.8. Change the Gateway Address (Static)

Command and Response

- ▶ SET•/MANAGEMENT/NETWORK.StaticGatewayAddress=<gw_address>
- ◀ pw•/MANAGEMENT/NETWORK.StaticGatewayAddress=<gw_address>

Example

- ▶ SET /MANAGEMENT/NETWORK.StaticGatewayAddress=172.0.0.1
- ◀ pw /MANAGEMENT/NETWORK.StaticGatewayAddress=172.0.0.1

7.11. EDID Management

7.11.1. Query the Emulated EDIDs

Command and Response

- ▶ GET•/EDID.EdidStatus
- ◀ pr•/EDID.EdidStatus=<E_loc>:<En>

Example

- ▶ GET /EDID.EdidStatus
- ◀ pr EDID.EdidStatus=F46:E1;F47:E2;F47:E3;F47:E4;F47:E5;F47:E6

Explanation

All emulated EDID memories (inputs) are listed with the EDID number that is currently emulated on the input separated by semicolons. Above example shows that F46 EDID (46th Factory EDID) is emulated on I1 (E1) port, and F47 is emulated on all other input ports. Port numbers are listed in section [Input and Output Port Numbering](#).

7.11.2. Query the Validity of a Dynamic EDID

Command and Response

- ▶ GET•/EDID/D/<Dn>.Validity
- ◀ pr•/EDID/D/<Dn>.Validity=<logical_value>

Parameters

Identifier	Parameter description	Value	Explanation
<logical_value>	EDID validity status	true	The selected EDID is valid.
		false	The selected EDID is invalid.

Example

- ▶ GET /EDID/D/D1.Validity
- ◀ pr /EDID/D/D1.Validity=true

7.11.3. Emulating an EDID to an Input Port

Command and Response

- ▶ CALL•/EDID:switch(<source>:<destination>)
- ◀ mO•/EDID:switch

Parameters

Identifier	Parameter description
<source>	Source EDID memory place: Factory / User / Dynamic.
<destination>	The emulated EDID memory of the desired input port.

Example

- ▶ CALL /EDID:switch(F49:E2)
- ◀ mO /EDID:switch

7.11.4. Copy an EDID to User Memory

Command and Response

- ▶ CALL•/EDID:copy(<Dn>|<En>|<Fn>|<Un>:<Um>)
- ◀ mO•/EDID:copy

Example

- ▶ CALL /EDID:copy(D1:U1)
- ◀ mO /EDID:copy

Explanation

The EDID of the last connected sink of D1 (Output 1) has been copied to U1.

7.11.5. Deleting an EDID to User Memory

Command and Response

- ▶ CALL•/EDID:delete(<Un>)
- ◀ mO•/EDID:delete

Example

- ▶ CALL /EDID:delete(U1)
- ◀ mO /EDID:delete

7.11.6. Resetting the Emulated EDIDs

Command and Response

- ▶ CALL•/EDID:reset(1)
- ◀ mO•/EDID:reset

Example

- ▶ CALL /EDID:reset(1)
- ◀ mO /EDID:reset

Explanation

Calling this method switches all emulated EDIDs to factory default one. See the table in [Factory Default Settings](#) section.

7.12. LW3 Commands - Quick Summary

System Commands

Querying the Product Name

- ▶ GET•/.ProductName

Set the Device Label

- ▶ SET•/MANAGEMENT/UID/DeviceLabel=<custom_name>

Query the Serial Number

- ▶ GET•/.SerialNumber

Set the Background Light of the LCD Screen

- ▶ SET•/MANAGEMENT/UI.LcdMenuBackLightMode=<parameter>

Set the Displayed Text on the LCD Screen

- ▶ CALL•/MANAGEMENT/UI:LcdMenuMessage(<time>; <1stline_text>;<2ndline_text>)

Identify the Device

- ▶ CALL•/MANAGEMENT/UI:identifyMe()

Resetting the Matrix

- ▶ CALL•/SYS:Reset()

Restore the Factory Default Settings

- ▶ CALL•/SYS:factoryDefaults()

Video Port and Crosspoint Settings

Query the Status of Source Port

- ▶ GET•/MEDIA/VIDEO/XP.SourcePortStatus

Query the Status of Destination Port

- ▶ GET•/MEDIA/XP/VIDEO.DestinationPortStatus

Query the Video Crosspoint Setting

- ▶ GET•/MEDIA/VIDEO/XP.DestinationConnectionList

Switching Video Input

- ▶ CALL•/MEDIA/VIDEO/XP:switch(<in>;<out>)

HDCP Setting (Input Port)

- ▶ SET•/MEDIA/VIDEO/<In>.HdcpEnable=<logical_value>

HDCP Setting (Output Port)

- ▶ SET•/MEDIA/VIDEO/<out>.HdcpModeSetting=<parameter>

Query the Video Autoselect Settings

- ▶ GET•/MEDIA/VIDEO/XP.DestinationPortAutoselect

Change the Autoselect Mode

- ▶ CALL•/MEDIA/VIDEO/XP:setDestinationPortAutoselect(<On>;<On_set>)

Query the Input Port Priority

- ▶ GET•/MEDIA/VIDEO/XP.PortPriorityList

Changing the Input Port Priority

- ▶ CALL•/MEDIA/VIDEO/XP:setAutoselectionPriority(<in>(<out>);<prio>)

Mute Input Port

- ▶ CALL•/MEDIA/VIDEO/XP:muteSource(<in>)

Unmute Input Port

- ▶ CALL•/MEDIA/VIDEO/XP:unmuteSource(<in>)

Lock Input Port

- ▶ CALL•/MEDIA/VIDEO/XP:lockSource(<in>)

Unlock Input Port

- ▶ CALL•/MEDIA/VIDEO/XP:unlockSource(<in>)

Mute Output Port

- ▶ CALL•/MEDIA/VIDEO/XP:muteDestination(<out>)

Unmute Output Port

- ▶ CALL•/MEDIA/VIDEO/XP:unmuteDestination(<out>)

Lock Output Port

- ▶ CALL•/MEDIA/VIDEO/XP:lockDestination(<out>)

Unlock Output Port

- ▶ CALL•/MEDIA/VIDEO/XP:unlockDestination(<out>)

Test Pattern Generator - Mode

- ▶ SET•/MEDIA/VIDEO/<out>.TpgMode=<mode>

Test Pattern Generator - Clock Source

- ▶ SET•/MEDIA/VIDEO/<On>.TpgClockSource=<clock_source>

Test Pattern Generator - Pattern setting

- ▶ SET•/MEDIA/VIDEO/<On>.TpgPattern=<pattern>

Query the Current TPS Mode

- ▶ GET•/REMOTE/<source>|<destination>.tpsMode

TPS Mode Setting on TPS Ports

- ▶ SET•/REMOTE/<source>|<destination>.tpsModeSetting=<TPS_mode>

HDMI Mode Settings (Output Ports)

- ▶ SET•/MEDIA/VIDEO/<out>.HdmiModeSetting=<HDMI_mode>

Audio Port Settings**Signal Source Selection**

- ▶ SET•/MEDIA/VIDEO/<in>|<out>.AudioMode=<audio_mode>

Analog Audio Input Level Settings - Volume

- ▶ SET•/MEDIA/AUDIO/<in>.Volume=<volume>

Analog Audio Input Level Settings - Balance

- ▶ SET•/MEDIA/AUDIO/<in>.Balance=<balance>

Analog Audio Input Level Settings - Gain

- ▶ SET•/MEDIA/AUDIO/<in>.Gain=<gain>

Analog Audio Output Level Settings - Volume

- ▶ SET•/MEDIA/AUDIO/<out>.Volume=<volume>

Analog Audio Output Level Settings - Balance

- ▶ SET•/MEDIA/AUDIO/<in>.Balance=<balance>

Analog Audio Output Level Settings - Gain

- ▶ SET•/MEDIA/AUDIO/<out>.Gain=<gain>

Analog Audio Output Level Settings - Mute / Unmute

- ▶ SET•/MEDIA/AUDIO/<out>.MuteSetting=<logical_value>

RS-232 Port Configuration**Protocol Setting**

- ▶ SET•/MEDIA/UART/<port>.ControlProtocol=<number>

BAUD Rate Setting

- ▶ SET•/MEDIA/UART/<port>.Baudrate=<number>

Databits Setting

- ▶ SET•/MEDIA/UART/<port>.DataBits=<databits>

Stopbits Setting

- ▶ SET•/MEDIA/UART/<port>.StopBits=<number>

Parity Setting

- ▶ SET•/MEDIA/UART/<port>.Parity=<number>

RS-232 Operation Mode

- ▶ SET•/MEDIA/UART/<port>.Rs232Mode=<number>

Command Injection Mode

- ▶ SET•/MEDIA/UART/<port>.CommandInjectionEnable=<logical_value>

Message Sending via Ethernet Port**Sending a TCP Message (ASCII-format) via Ethernet**

- ▶ CALL•/MEDIA/ETHERNET:tcpMessage(<IP_address>:<port_no>=<message>)

Sending a TCP Text (ASCII-format) via Ethernet

- ▶ CALL•/MEDIA/ETHERNET:tcpText(<IP_address>:<port_no>=<text>)

Sending a TCP Binary Message (HEX-format) via Ethernet

- ▶ CALL•/MEDIA/ETHERNET:tcpBinary(<IP_address>:<port_no>=<HEX_message>)

Sending a UDP Message (ASCII-format) via Ethernet

- ▶ CALL•/MEDIA/ETHERNET:udpMessage(<IP_address>:<port_no>=<message>)

Sending a TCP Text (ASCII-format) via Ethernet

- ▶ CALL•/MEDIA/ETHERNET:udpText(<IP_address>:<port_no>=<text>)

Sending a UDP Binary Message (HEX-format) via Ethernet

- ▶ CALL•/MEDIA/ETHERNET:udpBinary(<IP_address>:<port_no>=<HEX_message>)

Message Sending via RS-232 Serial Port**Sending a Text (ASCII-format) via Serial Port**

- ▶ CALL•/MEDIA/UART/<port>:sendText(<message>)

Sending a Binary Message (HEX-format) via Serial Port

- ▶ CALL•/MEDIA/UART/<port>:sendBinaryMessage(<message>)

Sending a Message (ASCII-format) via Serial Port

- ▶ CALL•/MEDIA/UART/<port>:sendMessage(<message>)

Infrared Port Configuration**Enable Command Injection Mode**

- ▶ SET•/MEDIA/IR/<source>|<destination>.CommandInjectionEnable=<logical_value>

Enable/Disable Output Signal Modulation

- ▶ SET•/MEDIA/IR/<destination>.EnableModulation=<logical_value>

Change Command Injection Port Number

- ▶ SET•/MEDIA/IR/<source>|<destination>.CommandInjectionPort=<port_no>

Network Configuration

Query the DHCP State

- ▶ GET•/MANAGEMENT/NETWORK.DhcpEnabled

Change the DHCP State

- ▶ SET•/MANAGEMENT/NETWORK.DhcpEnabled=<logical_value>

Query the IP Address

- ▶ GET•/MANAGEMENT/NETWORK.IpAddress

Change the IP Address (Static)

- ▶ SET•/MANAGEMENT/NETWORK.StaticIpAddress=<IP_address>

Query the Subnet Mask

- ▶ GET•/MANAGEMENT/NETWORK.NetworkMask

Change the Subnet Mask (Static)

- ▶ SET•/MANAGEMENT/NETWORK.StaticNetworkMask=<netmask>

Query the Gateway Address

- ▶ GET•/MANAGEMENT/NETWORK.GatewayAddress

Change the Gateway Address (Static)

- ▶ SET•/MANAGEMENT/NETWORK.StaticGatewayAddress=<gw_address>

EDID Management

Query the Emulated EDIDs

- ▶ GET•/EDID.EdidStatus

Query the Validity of a Dynamic EDID

- ▶ GET•/EDID/D/<Dn>.Validity

Emulating an EDID to an Input Port

- ▶ CALL•/EDID:switch(<source>:<destination>)

Copy an EDID to User Memory

- ▶ CALL•/EDID:copy(<Dn>|<En>|<Fn>|<Un>:<Um>)

Deleting an EDID to User Memory

- ▶ CALL•/EDID:delete(<Un>)

Resetting the Emulated EDIDs

- ▶ CALL•/EDID:reset(1)

8

Firmware Upgrade

This chapter is meant to help customers perform firmware upgrades on our products by giving a few tips on how to start and by explaining the features of the Lightware Device Updater (LDU2) software over LAN. The latest software and firmware pack can be downloaded from www.lightware.com.

- ▶ [INTRODUCTION](#)
- ▶ [PREPARATION](#)
- ▶ [RUNNING THE SOFTWARE](#)
- ▶ [THE UPGRADING STEPS](#)
- ▶ [IF THE UPGRADE IS NOT SUCCESSFUL](#)

8.1. Introduction

Lightware Device Updater v2 (LDU2) software is the second generation of the LFP-based (Lightware Firmware Package) firmware upgrade process.



DIFFERENCE: The software can be used for uploading the packages with LFP2 extension only. LDU2 is not suitable for using LFP files, please use the LDU software for that firmware upgrade.

8.2. Preparation

Most Lightware devices can be controlled over more interfaces (e.g. Ethernet, USB, RS-232). But the firmware can be upgraded usually over one dedicated interface, which is the Ethernet in most cases.

If you want to upgrade the firmware of one or more devices you need the following:

- **LFP2 file,**
- **LDU2 software** installed on your PC or Mac.

Both can be downloaded from www.lightware.com/downloads.

Optionally, you can download the **release notes** file in HTML format.

8.2.1. About the Firmware Package (LFP2 File)

All the necessary tools and binary files are packed into the LFP2 package file. You need only this file to do the upgrade on your device.

- This allows the use of the same LFP2 package for different devices.
- The package contains all the necessary components, binary, and other files.
- The release notes is included in the LFP2 file which is displayed in the window where you select the firmware package file in LDU2.

8.2.2. LDU2 Installation

ATTENTION! Minimum system requirement: 2 GB RAM.

INFO: The Windows and the Mac application has the same look and functionality.

Download the software from www.lightware.com/downloads.

Installation Modes

Normal install	Snapshot install
Available for Windows and macOS	Available for Windows
The installer can update only this instance	Cannot be updated
One updateable instance may exist for all users	Many different versions can be installed for all users

ATTENTION! Using the default Normal install is highly recommended.

Running the Installer

If you have a previously installed version you will be prompted to remove the old version before installing the new one.

Installation in case of Windows OS

Run the installer. If the User Account Control displays a pop-up message click **Yes**.

Using the **Normal install** (default setting) is highly recommended.

Installation in case of macOS

Mount the DMG file with double clicking on it and drag the LDU2 icon over the Applications icon to copy the program into the Applications folder. If you want to copy LDU2 into another location just drag the icon over the desired folder.

INFO: This type of installer is equal with the **Normal install** of Windows.

8.3. Running the Software

You have two options:

- **Starting the LDU2** by double-clicking on the shortcut/program file, or
- Double-clicking on an **LFP2 file**.



LDU2 Auto-Update

At startup, the software checks if a newer version is available on the web.

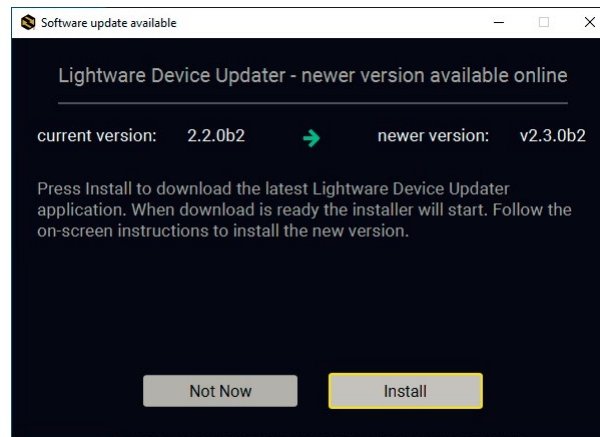

Main Screen

When the software is started by the shortcut, the device discovery screen appears. Press the **Search for devices** button to start finding the Lightware devices:

SEARCH FOR DEVICES

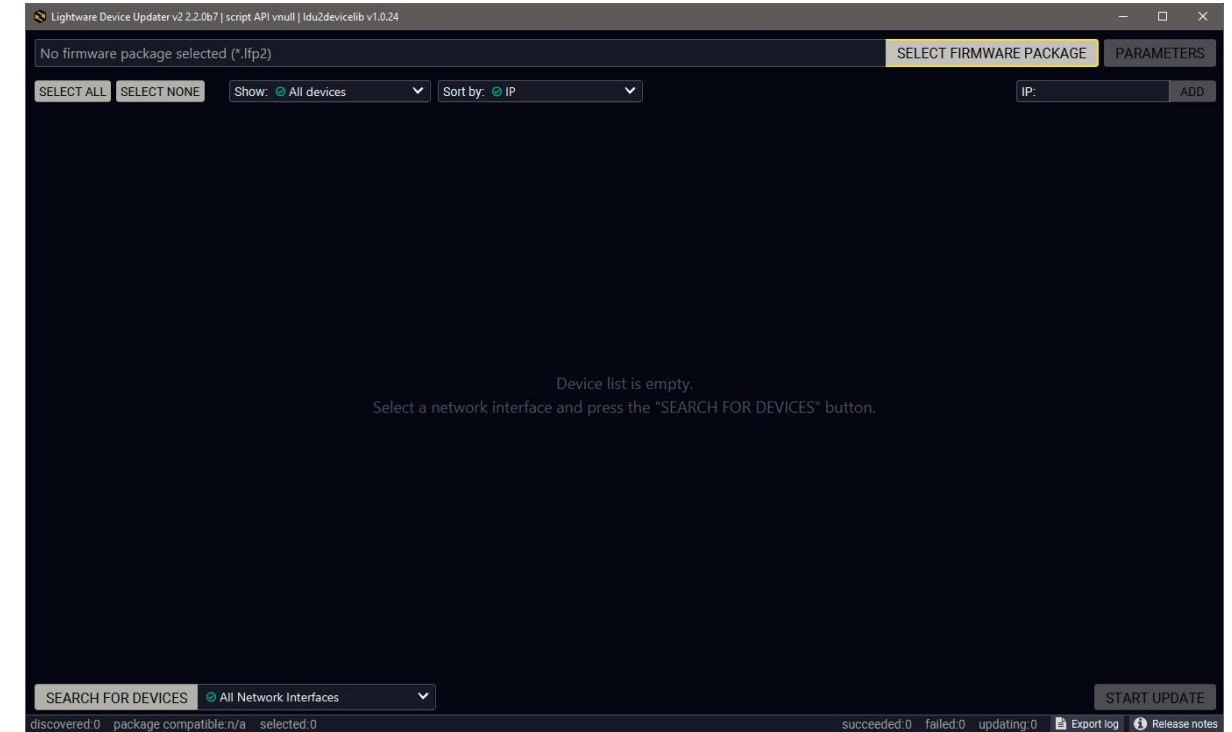

If you start the software by double-clicking on the LFP2 file, the firmware will be loaded. Press the **Search for devices** button; all the devices will be listed which are compatible with the selected firmware pack.





INFO: If you press the **Select firmware package** button, the release notes of the LFP2 file will be displayed in the right panel; see the [Step 1. Select the Firmware Package.](#) section.

Device List

When the discovery has completed, the devices available on the network are listed in the application.

Device ID	Device Name	IP Address	Package	Hardware ID
1.	HDMI-TPS-RX220AK	192.168.0.75	v1.4.0b14	V13_CAA0
2.	UBEX-MMU-X200	192.168.0.81	v1.2.2b1	V10_AAXX
3.	UMX-TPS-TX140K	192.168.0.118	v1.4.0b8	V20_DAX0
4.	MMX4x2-HT200	192.168.4.33	v0.0.0b0	V11_AAA0
5.	MEX-111--422-999-999	192.168.4.45		
6.	MEX-111--422-999-999	192.168.4.85		
7.	UBEX-MMU-X200	192.168.4.138	v1.3.0b0	V10_AAXX
8.	MX2-48x48-DH-24DPio-A-R	192.168.4.183	v1.6.1b2	V11_AAA0

Legend of the Icons

-  **IP address editor** The IP address of the device can be changed in the pop-up window.
-  **Identify me** Clicking on the icon results the front panel LEDs blink for 10 seconds which helps to identify the device physically.
-  **Favorite device** The device has been marked, thus the IP address is stored. When a device is connected with that IP address, the star will highlighted in that line.
-  **Further information available** Device is unreachable. Change the IP address using the front panel LCD menu or the IP address editor of the LDU2.

8.4. The Upgrading Steps

ATTENTION! While the firmware is being upgraded, the normal operation mode is suspended as the device is switched to bootload mode. Signal processing is not performed. Do not interrupt the firmware upgrade. If any problem occurs, reboot the unit and restart the process.

Keeping the Configuration Settings

By default, device configuration settings are restored when firmware upgrade is finished. If factory reset has been chosen in the parameters window, all device settings will be erased. In the case of factory reset, you can save the settings of the device in the Lightware Device Controller software and restore it later.

The following flow chart demonstrates how this function works in the background.

1. Create a backup

The current configuration of the device is being saved into a configuration backup file on your computer.

2. Start the Upgrade

The device reboots and starts in bootload mode (firmware upgrade mode).

3. Upgrade

The CPU firmware is changed to the new one.

4. Factory reset

All configuration settings are restored to the factory default values.

5. Conversion / Restore

The firmware package checks the backup data before the restore procedure, and if it is necessary, a conversion is applied to avoid incompatibility problems between the firmware versions. All configuration settings are restored to the device after the conversion.

If the factory default option is selected in the Parameters window, the conversion / restore procedure will not be performed!

6. Finish

Once the firmware upgrade procedure is finished, the device reboots and is ready to use.

Step 1. Select the Firmware Package.

Click on the **Select Firmware Package** button and navigate to the location where the LFP2 file was saved. When you click on the name of package, the preview of the release notes are displayed in the right panel.

SELECT FIRMWARE PACKAGE

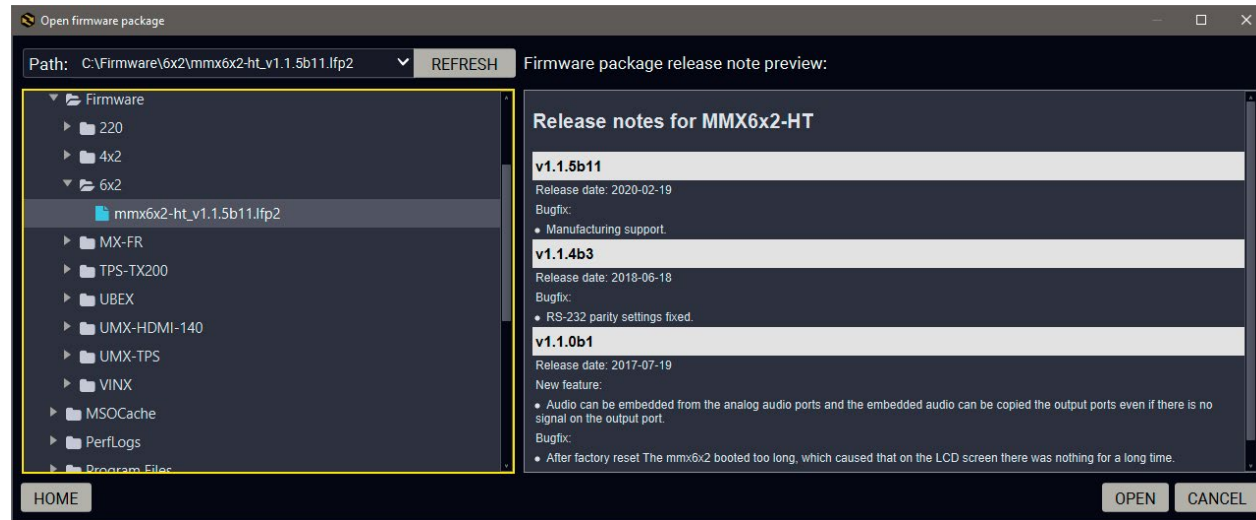

After the package file is loaded, the list is filtered to show the compatible devices only. The current firmware version of the device is highlighted in orange if it is different from the version of the package loaded.

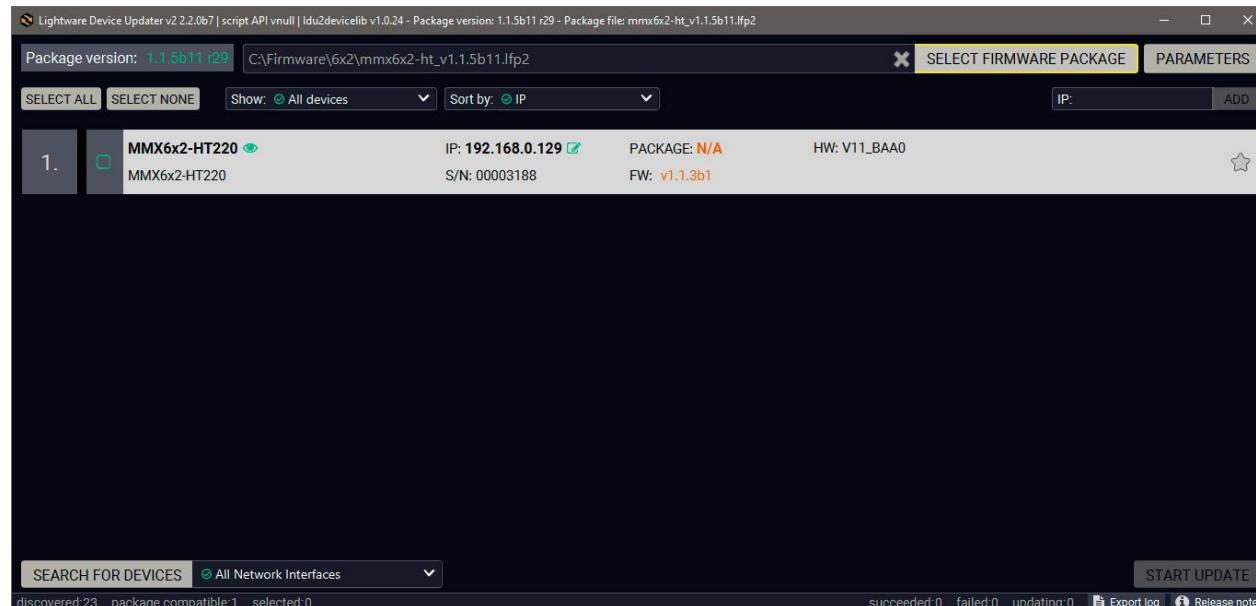

INFO: If you start the upgrade by double-clicking on the LFP file, above screen will be loaded right away.

The Meaning of the Symbols



Show details

Service mode

The log about the upgrading process of the device can be displayed in a new window.

The device is in bootload mode. Backup and restore cannot be performed in this case.

Step 2. Select the desired devices for upgrading.

Select the devices for upgrading; the selected line will be highlighted in green.

If you are not sure which device to select, press the **Identify me** button. It makes the front panel LEDs blink for 10 seconds. The feature helps to find the device physically.

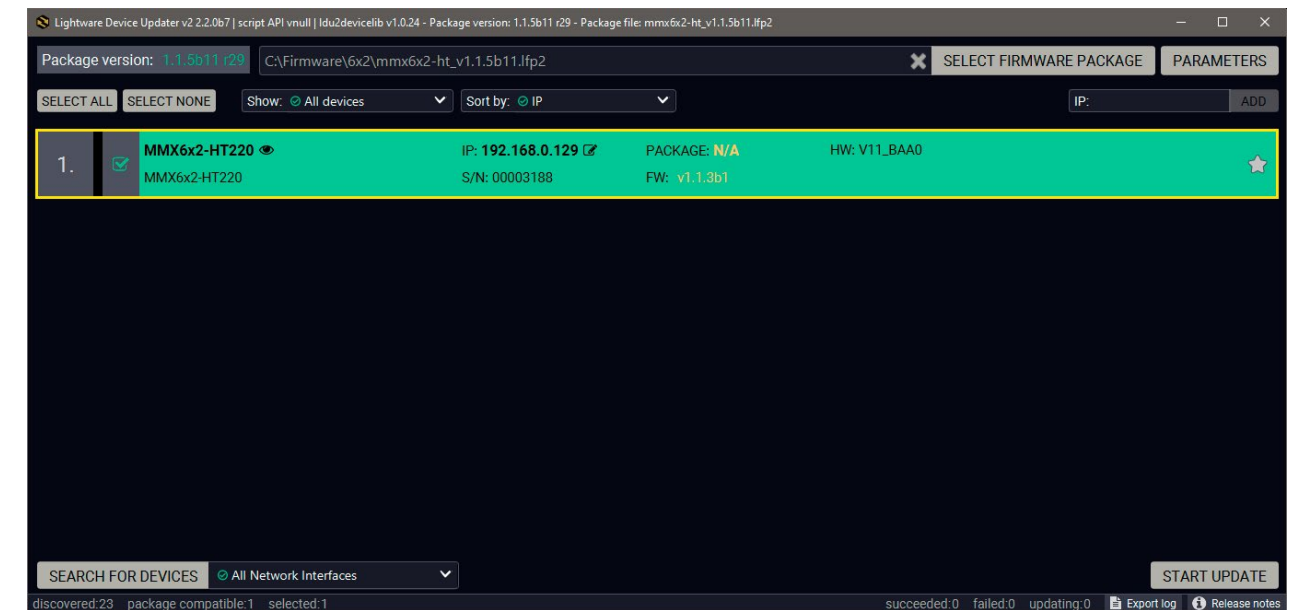

Step 3. Check the upgrade parameters.

Clicking on the **Parameters** button, special settings will be available:

- Creating a backup about current device configuration,
- Restoring the configuration or reloading the factory default settings after the firmware upgrade.

PARAMETERS

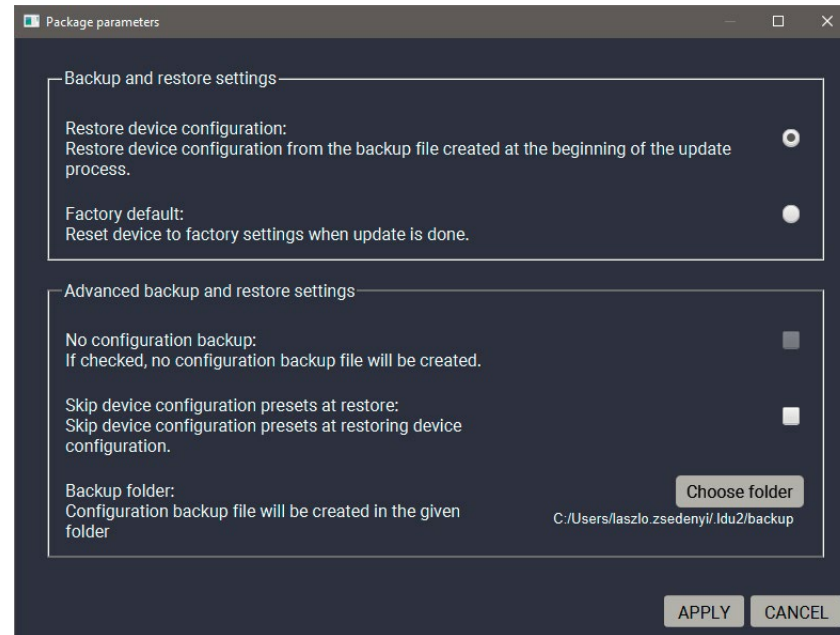

Please arrange the settings carefully.

Step 4. Start the update and wait until it is finished.

Click on the **Start Update** button to start the procedure. The status is shown in percent in the right side of the device line and the overall process in the bottom progress bar.

START UPDATE

INFO: The device might reboot during the firmware upgrade procedure.

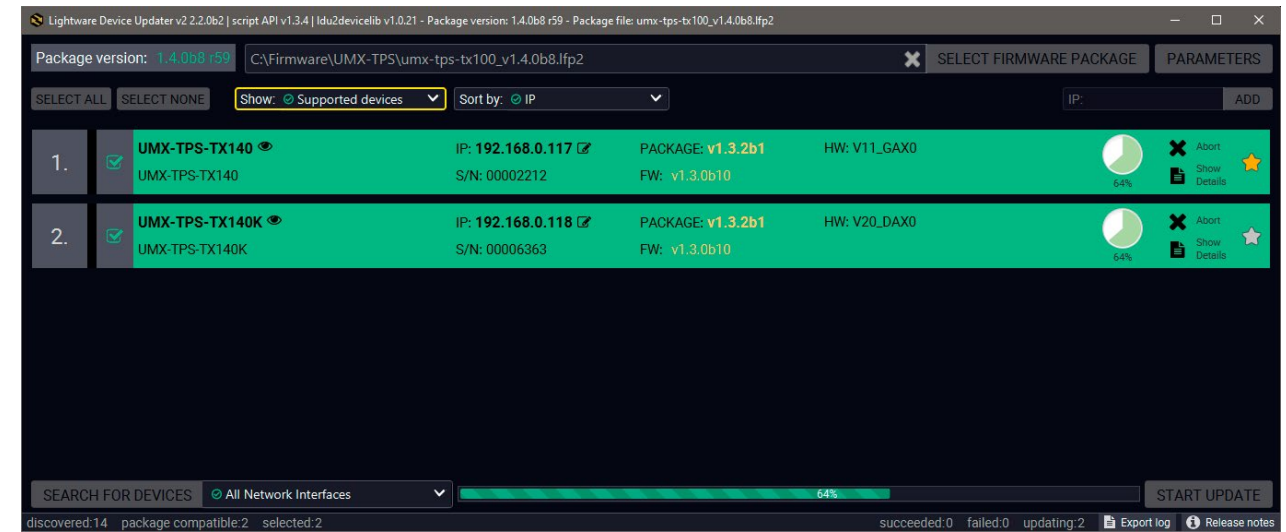

When the progress bar reaches 100% (**Done** is displayed at all devices), the upgrade of all devices are finished successfully and a message appears; you can close the software.

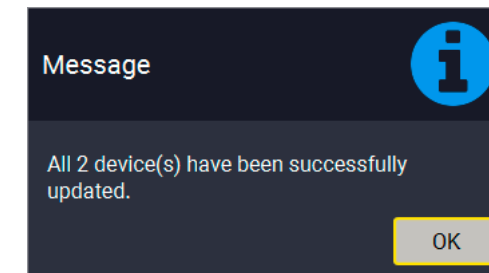
**Step 5. Wait until the unit reboots with the new firmware.**

Once the firmware upgrade procedure is completed, the device is rebooted with the new firmware. Shutting down and restarting the device is recommended.

8.5. If the Upgrade is not successful

- Restart the process and try the upgrade again.
- If the device cannot be switched to bootload (firmware upgrade) mode, you can do that manually as written in the [Enter bootload mode](#) section. Please note that backup and restore cannot be performed in this case.
- If the backup cannot be created for some reason, you will get a message to continue the process without backup or stop the upgrade. A root cause can be that the desired device is already in bootload (firmware upgrade) mode, thus, the normal operation mode is suspended and backup cannot be made.
- If an upgrade is not successful, the **Export log** button becomes red. If you press the button, you can download the log file as a ZIP package which can be sent to Lightware Support if needed. The log files contain useful information about the circumstances to find the root cause.





9

Troubleshooting

Usually, if the system seems not to transport the signal as expected, the best strategy for troubleshooting is to check signal integrity through the whole signal chain starting from source side and moving forward to receiver end.

At first, check front panel LEDs and take the necessary steps according to their states. For more information about front and rear panel LEDs of the matrix refer to [Front View - All Models](#) and [Rear View](#) section.

















Pictogram Legend



















-  Section to connections/cabling.
-  Section to front panel operation.
-  Section to LDC software.
-  Section to LW2 protocol commands.
-  Section to LW3 protocol commands.















The following sections are available in the chapter:

- ▶ [USE CASE STUDIES](#)
- ▶ [HOW TO SPEED UP THE TROUBLESHOOTING PROCESS](#)

9.1. Use Case Studies

Symptom	Root cause	Action	Refer to	
Video signal				
No picture on the video output	Device(s) not powered properly	Check the matrix and the other devices if they are properly powered; try to unplug and reconnect them.		4.2
	Cable connection problem	Cables must fit very well, check all the connectors.		3.3
	No incoming signal	No video signal is present on the HDMI/TPS input ports. Check the source device and the HDMI/TPS cables.		3.3.1 3.3.5
	Not the proper video port is the active one	Check the video crosspoint settings.		4.2.1
				5.4
				6.3.6
				7.4.3
	Not the proper interface is the active one	If the source/display has more connectors, check if the proper interface is selected.		
Output port is muted	Check the mute state of output ports.		5.5.2	
			6.3.2	
			7.4.1	
Display is not able to receive the video format	Check the emulated EDID and select another (e.g. emulate the display's EDID on the input port).		5.8	
			7.11	
Image is green or magenta colored	Wrong colorspace was chosen		4.4.5	
			5.5.8	
Autoselect not chooses the requested input	Incorrect priority settings		5.5.4	
			6.3.9	
			7.4.9	

Symptom	Root cause	Action	Refer to
Audio signal			
No audio is present on output	Other audio port is switched to the output	Check the audio settings of both the input and output ports.	 4.4.4
			 4.4.5
			 5.5.7
	Output port is muted	Check the output port properties.	 7.5
			 4.4.5
			 5.5.7
Analog audio input/output: volume is set very low	Check the Analog audio input/output port settings (Volume).	 4.4.4	
		 4.4.5	
		 5.5.7	
Not the corresponding audio sounds	Other audio port is switched to the output	Checked not only the audio settings of the output port but the input ports', too.	 4.4.4
			 4.4.5
			 5.5.7
			 7.5.2
			 7.5.5
			 7.5.5
HDMI output signal contains no audio	HDMI mode was set to DVI	Check the properties of the output port and set to HDMI or Auto.	 4.4.5
			 5.5.8
	DVI EDID is emulated	Check the EDID and select an HDMI EDID to emulate.	 5.8
			 7.11

Symptom	Root cause	Action	Refer to
RS-232 signal			
Connected serial device cannot be controlled	Cable connection problem	Check the connectors to fit well; check the wiring of the plugs.	 3.3.3
	Serial settings are different	Check the port settings of the matrix and the connected serial device(s). Pay attention to link and/or local ports.	 5.9.1  7.6
No RS-232 signal on output	RS-232 data transmission is available between the local RS-232 port and the LAN port (not TPS port).	Operation mode of the local RS-232 can be Command Injection and enabling of the CI mode can be also applied.	 5.9.1
			 7.6.6
Ethernet			
No LAN connection can be established	Incorrect IP address is set (direct connect)	Restore the factory default settings (with fix IP).	 4.4.1
			 5.11.3
			 6.2.11
	IP address conflict	Change the IP address to a not reserved one or enable DHCP if DHCP server exists in the network.	 7.3.8
			 4.4.2
			 5.11.2
 7.9			
Event Manager			
Action does not start, although condition is completed.	Too much delay was set.	Check the delay setting on the event Event Editor window. Try it again with zero delay (do not forget verify with Apply button).	 5.10.1
	The event was not verified/enabled.	Both Condition and Action (and optionally the Delay) need clicking to verify them. Check if the Event is Enabled on the Events tab.	 5.10.1

9.2. How to Speed Up the Troubleshooting Process

Lightware's technical support team is always working hard to provide the fastest support possible. Our team's response time is one of the best in the industry and in the toughest of cases we can directly consult with the hardware or software engineer who designed the product to get the information from the most reliable source.

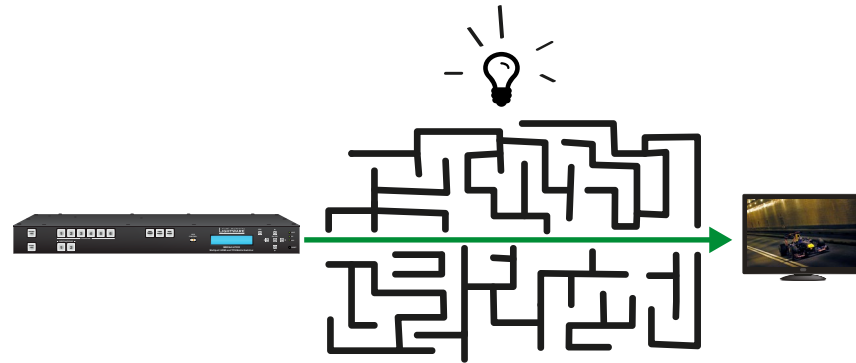

However, the troubleshooting process can be even faster... with your help.

There are certain pieces of information that push us in the right direction to finding the root cause of the problem. If we receive most of this information in the first e-mail or it is gathered at the time when you call us, then there is a pretty high chance that we will be able to respond with the final solution right away.

This information is the following:

- Schematic (a pdf version is preferred, but a hand drawing is sufficient).
- Serial number(s) of the device(s) (it is either printed somewhere on the box or you can query it in the Device Controller software or on the built-in website).
- Firmware versions of the devices (please note that there may be multiple CPUs or controllers in the device and we need to know all of their firmware versions, a screenshot is the best option).
- Cable lengths and types (in our experience, it's usually the cable).
- Patch panels, gender changers or anything else in the signal path that can affect the transmission.
- Signal type (resolution, refresh rate, color space, deep color).
- Emulated EDID(s) (please save them as file and send them to us).
- Actions to take in order to re-create the problem (if we cannot reproduce the problem, it is hard for us to find the cause).
- Photo or video about the problem ('image noise' can mean many different things, it's better if we see it too).
- Error logs from the Device Controller software.
- In the case of Event Manager issue the event file and/or backup file from the Device Controller software.

The more of the above information you can give us the better. Please send these information to the Lightware Support Team (support@lightware.com) to speed up the troubleshooting process.

10

Technologies

The following sections contain descriptions and useful technical information how the devices work in the background. The content is based on experiences and cases we met in the practice. These sections help to understand features and technical standards like the followings:

- ▶ EDID MANAGEMENT
- ▶ HDCP MANAGEMENT
- ▶ PIXEL ACCURATE RECLOCKING

10.1. EDID Management

10.1.1. Understanding the EDID

The Extended Display Identification Data (EDID) is the passport of display devices (monitors, TV sets, projectors). It contains information about the capabilities of the display, such as supported resolutions, refresh rates (these are called Detailed Timings), the type and manufacturer of the display device, etc.

After connecting a source to a display (DVI, HDMI, DP), the source reads out the EDID to determine the resolution and refresh rate of the image to be transmitted.

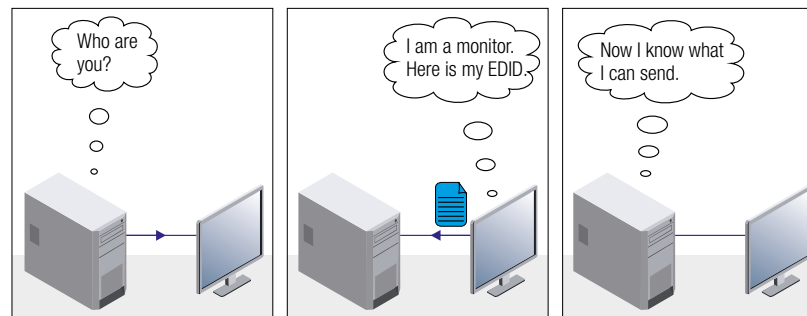

EDID Communication

Most DVI computer displays have 128-byte long EDID structure. However, Digital Televisions and HDMI capable displays may have another 128 bytes, which is called E-EDID and defined by CEA (Consumer Electronics Association). This extension contains information about additional Detailed Timings, audio capabilities, speaker allocation and HDMI capabilities. It is important to know that all HDMI capable devices must have CEA extension, but not all devices with CEA extension are HDMI capable.

Common Problems Related to EDID

Problem: "My system consists of the following: a computer, a Lightware device, a WUXGA (1920x1200) LCD monitor, and an SXGA (1280x1024) projector. I would like to see the same image on the monitor and the projector. What EDID should I choose on the Lightware device?"

Solution: If you want to see the image on both displays, you need to select the resolution of the smaller display (in this case SXGA), otherwise the smaller display may not show the higher resolution image.

Problem: "I have changed to a different EDID on an input port of the Lightware device to have a different resolution but nothing happens."

Solution: Some graphics cards and video sources read out the EDID only after power-up and later they do not sense that EDID has been changed. You need to restart your source to make it read out the EDID again.

10.1.2. Advanced EDID Management

Each DVI sink (e.g. monitors, projectors, plasma displays, etc...) must support the EDID data structure. Source BIOS and operating systems are likely to query the sink using DDC2B protocol to determine what pixel formats and interface are supported. DVI standard uses EDID data structure to identify the monitor type and capabilities. Most DVI sources (VGA cards, set top boxes, etc.) will output DVI signal after accepting the connected sink's EDID information. In the case of EDID readout failure or missing EDID, the source will not output DVI video signal.

Lightware devices provide the Advanced EDID Management function that helps system integration. The built-in EDID Router can store and emulate factory pre-programmed- and User programmable EDIDs. The EDID of the attached monitors or projectors for each output are stored in a non-volatile memory. This way the EDID of a monitor is available when the monitor is unplugged or switched off.

Any EDID can be emulated on any input. An emulated EDID can be copied from the EDID router's memory (static EDID emulation), or from the last attached monitor's memory (dynamic EDID emulation). For example, the Lightware device can be set up to emulate a sink device, which is connected to one of the outputs. In this case, the EDID automatically changes, if the monitor is replaced with another display device (as long as it has a valid EDID).

EDID is independently programmable for all inputs without affecting each other. All inputs have their own EDID circuit.

INFO: The user is not required to disconnect the video cable to change an EDID as opposed to other manufacturer's products. EDID can be changed even if a source is connected to the input and powered ON.

INFO: When EDID has been changed, the router toggles the HOTPLUG signal for 2 seconds. Some sources do not sense this signal. In such cases, the source device must be restarted or powered OFF and ON again.

10.2. HDCP Management

Lightware Visual Engineering is a legal HDCP adopter. Several functions have been developed which helps to solve HDCP related problems. Complex AV systems often have both HDCP and non-HDCP components. The matrix allows transmitting HDCP encrypted and unencrypted signals. The devices will be still HDCP compliant as they will never output an encrypted signal to a non-HDCP compliant display device. If an encrypted signal is switched to a non-compliant output, a red screen alert or muted screen will appear.

10.2.1. Protected and Unprotected Content

Many video sources send HDCP protected signal if they detect that the sink is HDCP capable – even if the content is not copyrighted. This can cause trouble if an HDCP capable device is connected between the source and the display. In this case, the content cannot be viewed on non-HDCP capable displays and interfaces like event controllers. Rental and staging technicians often complain about certain laptops, which are always sending HDCP encrypted signals if the receiver device (display, matrix router, etc.) reports HDCP compliancy. However, HDCP encryption is not required all the time e.g. computer desktop image, certain laptops still do that.

To avoid unnecessary HDCP encryption, Lightware introduced the HDCP enabling/disabling function: the HDCP capability can be disabled in the Lightware device. If HDCP is disabled, the connected source will detect that the sink is not HDCP capable, and turn off authentication.

10.2.2. Disable Unnecessary Encryption

HDCP Compliant Sink



All the devices are HDCP-compliant, no manual setting is required, both protected and unprotected contents are transmitted and displayed on the sink.

Not HDCP-compliant Sink 1.



Non-HDCP compliant sink is connected to the matrix. Some sources (e.g. computers) always send HDCP encrypted signals if the receiver device reports HDCP compliancy, however, HDCP encryption is not required all the time (e.g. computer desktop image). If HDCP is enabled in the matrix, the image will not be displayed on the sink.

Setting the HDCP parameter to Auto on the output port and disable HDCP on the input port, the transmitted signal will not be encrypted if the content is not protected. Thus, non-HDCP compliant sinks will display non-encrypted signal.

Not HDCP-compliant Sink 2.



The layout is the same as in the previous case: non-HDCP compliant display device is connected to the matrix but the source would send protected content with encryption. If HDCP is enabled on the input port of the matrix, the source will send encrypted signal. The sink is not HDCP compliant, thus, it will not display the video signal (but blank/red/muted/etc. screen). If HDCP is disabled on the input port of the matrix, the source will not send the signal. The solution is to replace the display device to an HDCP-capable one.

10.3. Pixel Accurate Reclocking

Signal reclocking is an essential important procedure in digital signal transmission. After passing the reclocking circuit, the signal becomes stable, jitter-free, and can be transmitted over more equipment like processors, or event controllers. Without reclocking, sparkles, noise, and jaggies appear on the image.

Lightware's sophisticated Pixel Accurate Reclocking technology fixes more problems than general TMDS reclocking. It removes not only intra-pair skew but inter-pair skew as well. The Pixel Accurate Reclocking circuit eliminates the following errors:

Intra-pair skew

Skew between the + and - wires within a differential wire pair (e.g. Data2- and Data2+). It's caused by different wire lengths or slightly different wire construction (impedance mismatch) in DVI cable. It results in jitter.

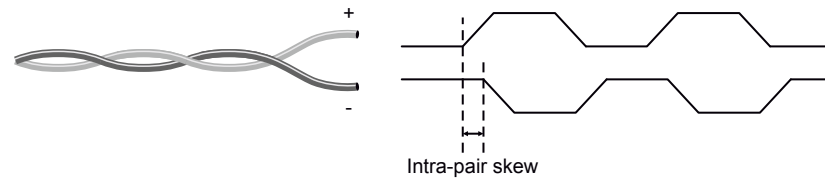

Inter-pair skew

Skew between two differential wire pairs in a cable. It is caused by different wire pair lengths or different number of twists in the DVI cable. Too much inter-pair skew results color shift in the picture or sync loss.

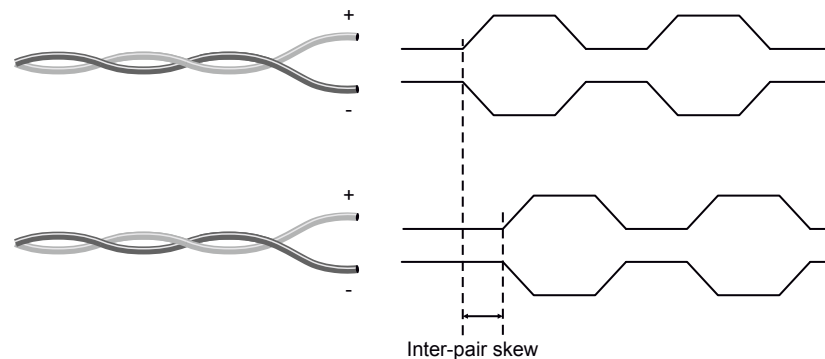

Jitter

Signal instability in the time domain. The time difference between two signal transitions should be a fixed value, but noise and other effects cause variations.

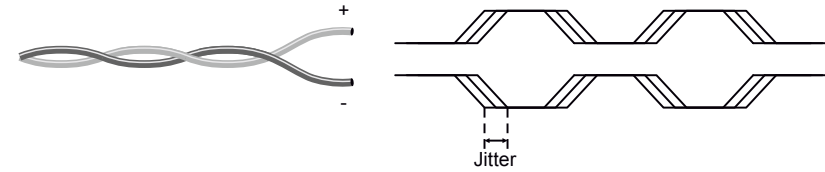

Noise

Electromagnetic interference between other electronic devices such as mobile phones, motors, etc. and the DVI cable are coupled onto the signal. Too much noise results in increased jitter.

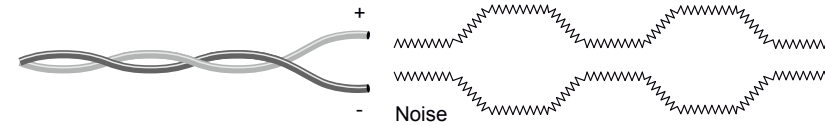

11

Appendix

Tables, drawings, guides, technical details as follows:

- ▶ [SPECIFICATIONS](#)
- ▶ [CABLE WIRING GUIDE](#)
- ▶ [MECHANICAL DRAWINGS](#)
- ▶ [CONTENT OF THE BACKUP FILE](#)
- ▶ [INPUT AND OUTPUT PORT NUMBERING](#)
- ▶ [MAXIMUM TWISTED PAIR DISTANCES](#)
- ▶ [FACTORY DEFAULT SETTINGS](#)
- ▶ [FACTORY EDID LIST](#)
- ▶ [FURTHER INFORMATION](#)

11.1. Specifications

General

Compliance	CE, UL
EMC compliance (emission)	IEC/EN 55032:2015
EMC compliance (immunity)	IEC/EN 55035:2017
RoHS compliance	EN 50581:2012
Warranty	3 years
Cooling	Fan, air flows right to left (as viewed from front)
Operating temperature	0 to +55°C (+32 to +122°F)
Operating humidity	10% to 90%, non-condensing

Power

Heat dissipation	120 BTU/h (max.), 85 BTU/h (typ.)
Power source	100-240 V AC; 50~60 Hz
Power consumption	120 W (max.), 40 W (typ.)
Power over TPS	DC 48V (IEEE 802.3af)
Enclosure	
Front panel buttons	Yes
Display	LCD, 2x16 characters
Rack mountable	Yes, 1U High (rack ears supplied)
Material	1 mm steel
Dimensions in mm	442 (482*) W x 43.9 H x 300 D
Dimensions in inch	17.4 (18.9*) W x 1.72 H x 11.8 D
Weight	4.8 kg

* with rack-mounting ears

RS-232 control

Serial port connector	3-pole Phoenix connector
Available Baud rates	between 4800 and 115200
Available Data bits	8 or 9
Available Parity	None / Odd / Even
Available Stop bits	1 / 1.5 / 2

Audio/Video ports

Crosspoint	6x2 video – any input(s) to any output(s)
HDCP compliant	Yes

TPS input and output ports

TPS port connector type	RJ45 connector
Compliance	HDBaseT
Transferred signals (TPS)	Video, Audio, RS-232, Infra-red, Ethernet
Max. video resolutions	1920x1080@120 Hz, 24 bit
.....	1600x1200@60 Hz, 36 bit
.....	3840x2160@30 Hz, 24 bit
Audio formats	8 ch. PCM, Dolby TrueHD, DTS-HD Master Audio 7.1
Reclocking	Pixel Accurate Reclocking

HDMI input and output ports

HDMI port connector type	19-pole HDMI Type A receptacle
Standard	DVI 1.0, HDMI 1.4
Max. video resolutions	1920x1080@120 Hz, 24 bit
.....	1600x1200@60 Hz, 36 bit
.....	3840x2160@30 Hz, 24 bit
Audio formats	
.....	8 channel PCM, Dolby TrueHD, DTS-HD Master Audio 7.1
Reclocking	Pixel Accurate Reclocking

Analog audio input ports

Signal transmission	Balanced and unbalanced audio
Gain	0 – 21 dB
Volume	-95 – 0 dB

Analog audio output ports

Signal transmission	Balanced and unbalanced audio
Gain	0 – 3 dB
Volume	-57 – 0 dB
Nominal Differential Output Level	+4 dBu @ 0 dB Gain
Nominal Differential Output Level	+7 dBu @ 3 dB Gain

EDID management

EDID emulation	Yes
EDID memory	119 factory presets, 12 user-programmable

11.2. Cable Wiring Guide

11.2.1. Cable Wiring Guide for Serial Data Transmission

The matrix switcher is built with 3-pole Phoenix connector. See below the two examples of the most common assembling cases.

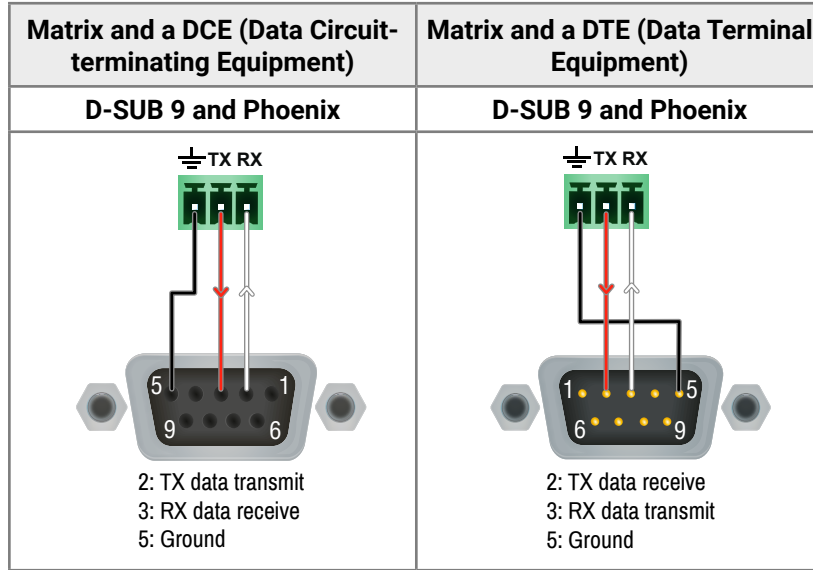

11.2.2. Audio Cable Wiring Guide

Inputs and outputs of audio devices are symmetric or asymmetric. The main advantage of the symmetric lines is the better protection against the noise therefore, they are widely used in the professional audio industry. Symmetric audio is most often referred to as balanced audio, as opposed to asymmetric, which is referred to as unbalanced audio. Lightware products are usually built with 5-pole Phoenix connectors so we would like to help users assembling their own audio cables. See the most common cases below.

ATTENTION! Symmetric and asymmetric lines can be linked with passive accessories (e.g. special cables), but in this case half of the line level is lost.

ATTENTION! There are numerous types of regularly used connector and cable types to connect audio devices. Please always make sure that a connector or cable fits your system before use.

ATTENTION! Never join the phase-inverted (negative, cold or -) poles (either right and left) to the ground or to each other on the output side, as this can damage the unit.

INFO: Use a galvanic isolation in case of a ground loop.

From Unbalanced Output to Balanced Input

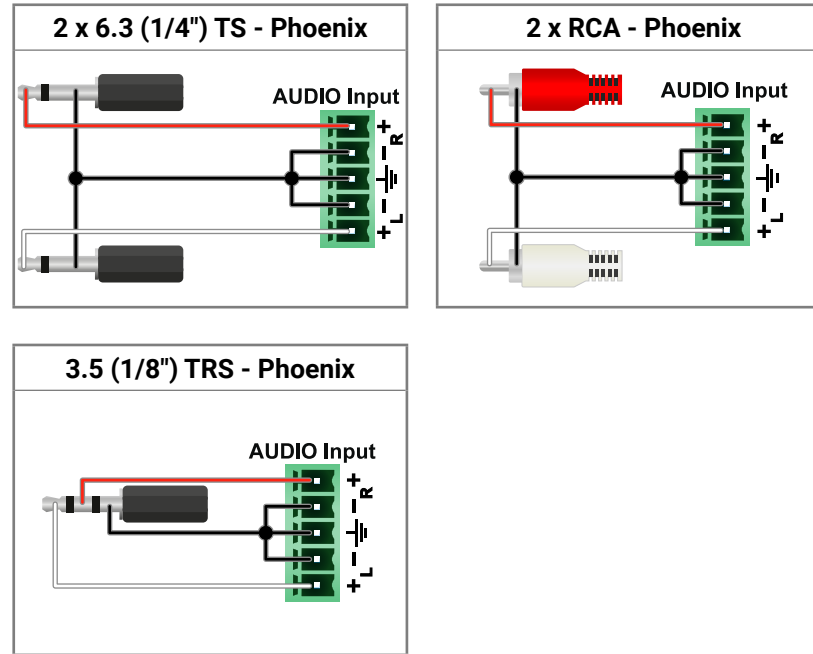

From Balanced Output to Unbalanced Input

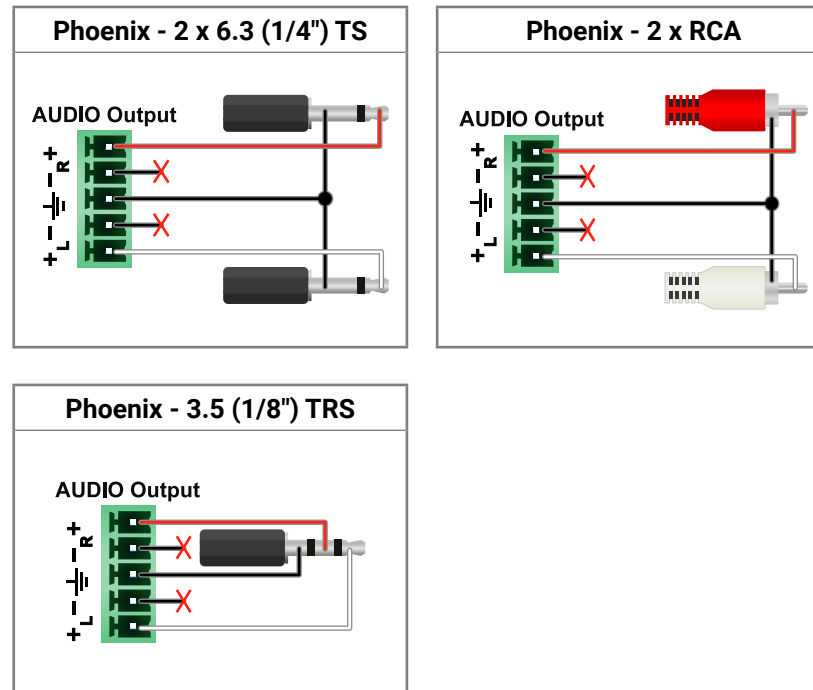

From Balanced Output to Balanced Input

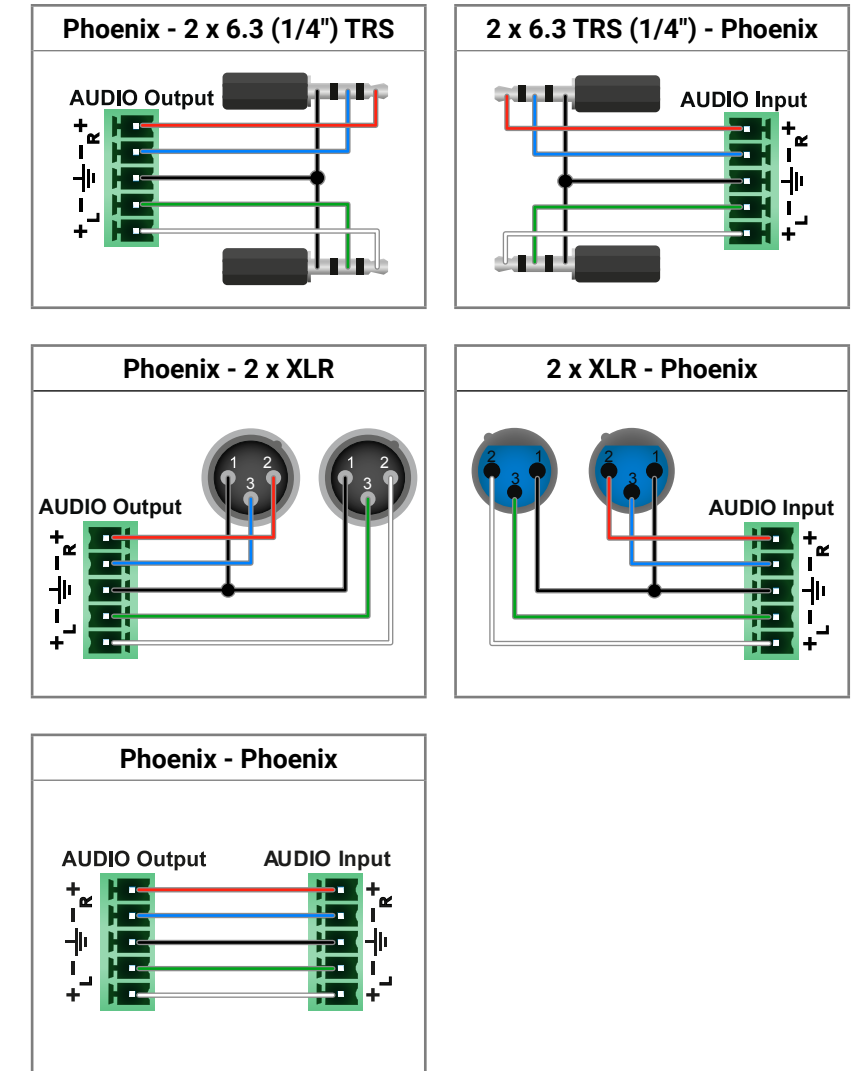

For more information about the cable wiring see the **Cable Wiring Guide** on our website www.lightware.com.

11.3. Mechanical Drawings

Dimensions are in mm.

Front View

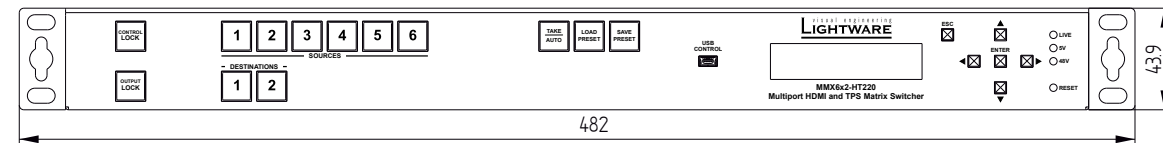

Rear View

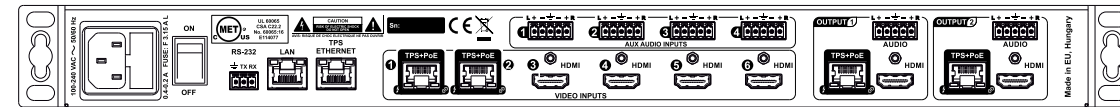

Side View

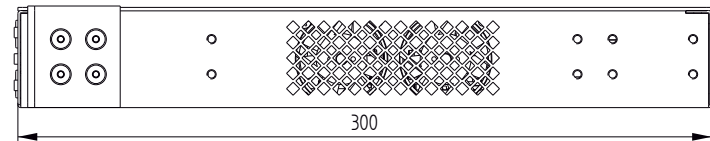

Top View

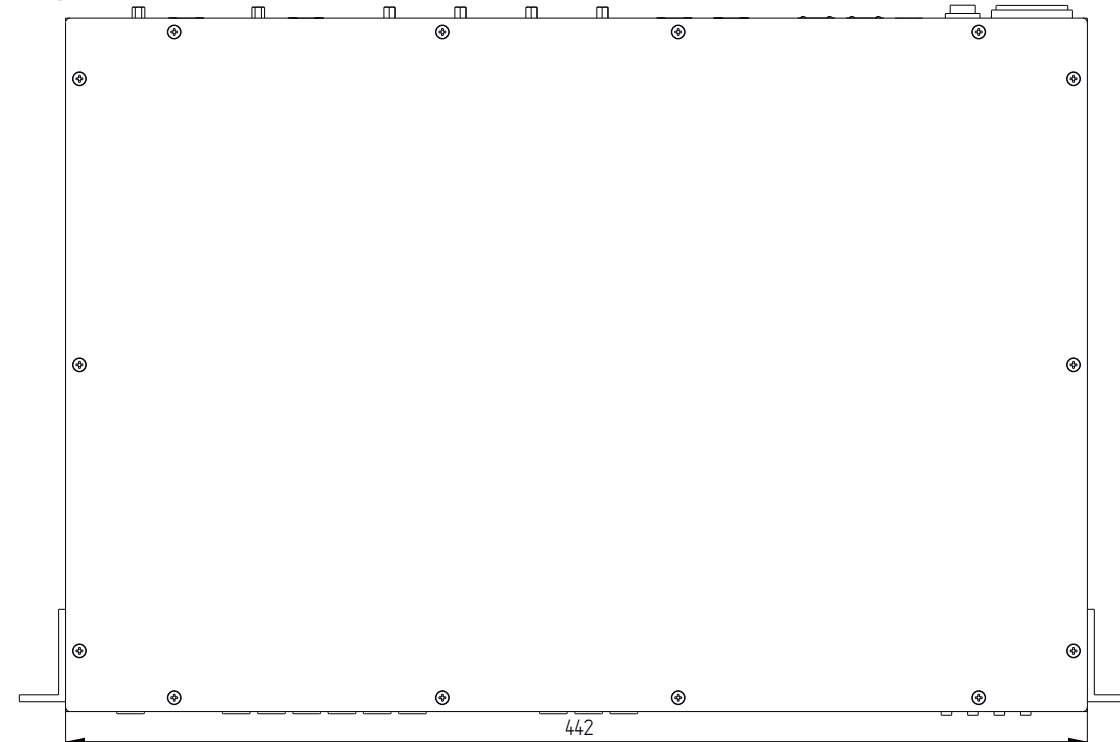

11.4. Content of the Backup File

The backup file contains numerous settings and parameters saved from the device. When the file is uploaded to a device, the followings will be overwritten:

Local serial port
RS-232 mode, Control protocol, Baud rate, Data bits, Stop bits, Parity
Port name and CI (Command Injection) port number
Ethernet settings
Enable/Disable on Local, and TPS Link lines
HDMI input port
Audio mode, HDCP setting, Port name
Analog audio input port
Volume, Balance, Gain, Port name
TPS input port
Port names, TPS mode, PoE (enabled / disabled), Ethernet (Enable / Disable)
Audio mode (Embedded / AUX1-4), HDCP setting
RS-232 mode, Control protocol, Baud rate, Data bits, Stop bits, Parity, CI port number
IR input port status, code length, repetition code, CI mode, and CI port number
IR output port status, code length, repetition code, CI mode, and CI port number
HDMI output port
Power +5V mode, Audio mode, HDCP mode, HDMI mode, Port name
Test pattern mode, clock source, and type
Analog audio output port
Volume, Balance, Gain, Mute setting, Port name
TPS output port
Port names, TPS mode, PoE (enabled / disabled), Ethernet (Enable / Disable)
Test pattern mode, clock source, and type
HDCP mode, HDMI mode, Power +5V mode
RS-232 mode, Control protocol, Baud rate, Data bits, Stop bits, Parity, CI port number
IR input port status, code length, repetition code, CI mode, and CI port number
IR output port status, code length, repetition code, CI mode, and CI port number
Network settings
DHCP status (enable / disable)
LW2, LW3 and HTTP port numbers
Static IP address, Network mask, Gateway address
Further settings
Emulated EDID list, User EDID data (U1-U12)
Event manager: All Events' settings (1-100)
All Presets' settings (1-6)

11.5. Input and Output Port Numbering

Port name	Video port no. (LW2)	Video port no. (LW3)	Audio port no.	EDID memory	RS-232 port no.	IR port no.	
						Input	Output
TPS input #1	1	I1	I1	E1	P2	S1	D1
TPS input #2	2	I2	I2	E2	P3	S2	D2
HDMI input #3	3	I3	I3	E3	-	-	-
HDMI input #4	4	I4	I4	E4	-	-	-
HDMI input #5	5	I5	I5	E5	-	-	-
HDMI input #6	6	I6	I6	E6	-	-	-
HDMI output #1	1	O1	O1	D1	-	-	-
HDMI output #2	2	O2	O2	D2	-	-	-
TPS output #1 *	3	O3	O3	D3	P4	S3	D3
TPS output #2 **	4	O4	O4	D4	P5	S4	D4
Analog audio input #1	-	-	I7	-	-	-	-
Analog audio input #2	-	-	I8	-	-	-	-
Analog audio input #3	-	-	I9	-	-	-	-
Analog audio input #4	-	-	I10	-	-	-	-
Analog audio output #1	-	-	O5	-	-	-	-
Analog audio output #2	-	-	O6	-	-	-	-
Local RS-232	-	-	-	-	P1	-	-

Mirrored outputs: O1-O3 and O2-O4.

* Only on MMX6x2-HT210 and MMX6x2-HT220 devices.

** Only on MMX6x2-HT220 device.

11.6. Maximum Twisted Pair Distances

Resolution	Pixel clock rate	Cable lengths (Auto / Longreach TPS mode)		
		CAT5e AWG24	CAT7 AWG26**	CAT7 AWG23
1024x768@60Hz	65 MHz	100 m / 130 m*	90 m / 120 m*	120 m / 170 m*
1280x720p@60Hz	73.8 MHz			
1920x1080p@60Hz / 24bpp	148.5 MHz	100 m / NA	90 m / NA	120 m / NA
1920x1200@60Hz	152.9 MHz			
1600x1200@60Hz	162 MHz	70 m / NA	70 m / NA	100 m / NA
1920x1080@60Hz / 36bpp	223.6 MHz			
3840x2160@30Hz UHD	297 MHz			
4096x2160@30Hz 4K	297 MHz			

* With Long reach operation mode which supports pixel clock frequencies up to 148.5 MHz.

** When remote powering is used with AWG26 cables, distances are 20% shorter.

11.7. Factory Default Settings

Parameter	Setting/Value
Network Settings	
IP address	192.168.0.100
Subnet mask	255.255.255.0
Static gateway	192.168.0.1
LW2 Port number	10001
LW3 Port number	6107
HTTP Port number	80
DHCP	disabled
TPS and HDMI Port Settings	
HDCP – on input ports	Enabled
HDCP – on output ports	Auto
Output TPS mode (on TPS output ports)	Auto
Output HDMI mode	Auto
Power 5V mode	Auto
No sync screen mode	Off
No sync screen color	Bar
No sync screen resolution	480p
Crosspoint state	HDMI I3 @ O1 & O3; HDMI I4 @ O2 & O4
Audio source	Embedded audio
Autoselect	Disabled
Autoselect video priority (from 0 to 5)	I1, I2, I3, I4, I5, I6
PoE feature	Enabled
Emulated EDID*	F47 - Factory (1920x1080@60Hz HDMI)
Analog Audio Port Settings	
Volume	0.00 dB
Balance	50 (center)
Gain	0.00 dB
RS-232 Settings	
Control protocol	LW2
Baud rate	57600
Databits / Parity / Stopbits	8 / No / 1
Operation mode (local and link ports)	CI (Command Injection)
Command Injection port nr. (Local)	8001
Command Injection port nr. (TPSIN1)	8002
Command Injection port nr. (TPSIN2)	8003
Command Injection port nr. (TPSOUT1)	8004
Command Injection port nr. (TPSOUT2)	8005

* The default EDID has been changed since firmware 1.1.0. The default EDID for firmware 1.0.0 is D1, dynamic.

11.8. Factory EDID List

Mem.	Resolution			Type
F1	640 x	480	@ 60.00 Hz	D
F2	848 x	480	@ 60.00 Hz	D
F3	800 x	600	@ 60.32 Hz	D
F4	1024 x	768	@ 60.00 Hz	D
F5	1280 x	768	@ 50.00 Hz	D
F6	1280 x	768	@ 59.94 Hz	D
F7	1280 x	768	@ 75.00 Hz	D
F8	1360 x	768	@ 60.02 Hz	D
F9	1280 x	1024	@ 50.00 Hz	D
F10	1280 x	1024	@ 60.02 Hz	D
F11	1280 x	1024	@ 75.02 Hz	D
F12	1400 x	1050	@ 50.00 Hz	D
F13	1400 x	1050	@ 60.00 Hz	D
F14	1400 x	1050	@ 75.00 Hz	D
F15	1680 x	1050	@ 60.00 Hz	D
F16	1920 x	1080	@ 50.00 Hz	D
F17	1920 x	1080	@ 60.00 Hz	D
F18	2048 x	1080	@ 50.00 Hz	D
F19	2048 x	1080	@ 60.00 Hz	D
F20	1600 x	1200	@ 50.00 Hz	D
F21	1600 x	1200	@ 60.00 Hz	D
F22	1920 x	1200	@ 50.00 Hz	D
F23	1920 x	1200	@ 59.56 Hz	D
F24	2048 x	1200	@ 59.96 Hz	D
F29	1920 x	1080	@ 60.00 Hz	Universal
F30	1440 x	480	@ 60.05 Hz	H
F31	1440 x	576	@ 50.08 Hz	H
F32	640 x	480	@ 59.95 Hz	H
F33	720 x	480	@ 59.94 Hz	H
F34	720 x	576	@ 50.00 Hz	H

Mem.	Resolution			Type
F35	1280 x	720	@ 50.00 Hz	H
F36	1280 x	720	@ 60.00 Hz	H
F37	1920 x	1080	@ 50.04 Hz	H
F38	1920 x	1080	@ 50.00 Hz	H
F39	1920 x	1080	@ 60.05 Hz	H
F40	1920 x	1080	@ 60.05 Hz	H
F41	1920 x	1080	@ 24.00 Hz	H
F42	1920 x	1080	@ 25.00 Hz	H
F43	1920 x	1080	@ 30.00 Hz	H
F44	1920 x	1080	@ 50.00 Hz	H
F45	1920 x	1080	@ 60.00 Hz	H
F46	1920 x	1080	@ 60.00 Hz	H
F47	1920 x	1080	@ 60.00 Hz	Universal
F48	1920 x	1080	@ 60.00 Hz	Universal
F49	1920 x	1080	@ 60.00 Hz	Universal
F90	1920 x	2160	@ 59.99 Hz	D
F91	1024 x	2400	@ 60.01 Hz	D
F92	1920 x	2400	@ 59.97 Hz	D
F93	2048 x	2400	@ 59.98 Hz	D
F94	2048 x	1536	@ 60.00 Hz	D
F95	2048 x	1536	@ 75.00 Hz	D
F96	2560 x	1600	@ 59.86 Hz	D
F97	3840 x	2400	@ 24.00 Hz	D
F98	1280 x	720	@ 60.00 Hz	H
F99	1920 x	1080	@ 60.00 Hz	H
F100	1024 x	768	@ 60.00 Hz	H
F101	1280 x	1024	@ 50.00 Hz	H
F102	1280 x	1024	@ 60.02 Hz	H
F103	1280 x	1024	@ 75.02 Hz	H
F104	1600 x	1200	@ 50.00 Hz	H

Mem.	Resolution			Type
F105	1600 x	1200	@ 60.00 Hz	H
F106	1920 x	1200	@ 59.56 Hz	H
F107	2560 x	1440	@ 59.95 Hz	H
F108	2560 x	1600	@ 59.86 Hz	H
F109	3840 x	2400	@ 24.00 Hz	H
F110	3840 x	2160	@ 24.00 Hz	H
F111	3840 x	2160	@ 25.00 Hz	H
F112	3840 x	2160	@ 30.00 Hz	H
F118	3840 x	2160	@ 30.00 Hz	Universal
F119	3840 x	2160	@ 30.00 Hz	Universal
F120	3840 x	2160	@ 60.00 Hz	H

Legend

D: DVI EDID

H: HDMI EDID

H3D: HDMI EDID with 3D support

U: Universal EDID

Please note that minor changes in the factory EDID list may be applied in the later firmware versions.

11.9. Further Information

Limited Warranty Statement

1. Lightware Visual Engineering LLC (Lightware) warrants to all trade and end user customers that any Lightware product purchased will be free from manufacturing defects in both material and workmanship for three (3) years from purchase unless stated otherwise below. The warranty period will begin on the latest possible date where proof of purchase/delivery can be provided by the customer. In the event that no proof can be provided (empty 'Date of purchase' field or a copy of invoice), the warranty period will begin from the point of delivery from Lightware.

1.1. 25G and MODEX product series will be subject to a seven (7) year warranty period under the same terms as outlined in this document.

1.2. If during the first three (3) months of purchase, the customer is unhappy with any aspect of a Lightware product, Lightware will accept a return for full credit.

1.3. Any product that fails in the first six (6) months of the warranty period will automatically be eligible for replacement and advanced replacement where available. Any replacements provided will be warranted for the remainder of the original unit's warranty period.

1.4. Product failures from six (6) months to the end of the warranty period will either be repaired or replaced at the discretion of Lightware. If Lightware chooses to replace the product then the replacement will be warranted for the remainder of the original unit's warranty period.

2. The above-stated warranty and procedures will not apply to any product that has been:

2.1. Modified, repaired or altered by anyone other than a certified Lightware engineer unless expressly agreed beforehand.

2.2. Used in any application other than that for which it was intended.

2.3. Subjected to any mechanical or electrical abuse or accidental damage.

2.4. Any costs incurred for repair/replacement of goods that fall into the above categories (2.1., 2.2., 2.3.) will be borne by the customer at a pre-agreed figure.

3. All products to be returned to Lightware require a return material authorization number (RMA) prior to shipment and this number must be clearly marked on the box. If an RMA number is not obtained or is not clearly marked on the box, Lightware will refuse the shipment.

3.1. The customer will be responsible for in-bound and Lightware will be responsible for out-bound shipping costs.

3.2. Newly repaired or replaced products will be warranted to the end of the originally purchased products warranty period.

Document Revision History

Rev.	Release date	Changes	Editor
1.0	12-11-2015	Initial version	Laszlo Zsedenyi
1.1	30-11-2015	Analog audio I/O parameters corrected	Laszlo Zsedenyi
1.2	15-01-2016	LW3 programmers' reference added, Autoselect feature added, LDC chapter updated, Event manager extended, Warranty section updated	Laszlo Zsedenyi
2.0	24-05-2016	LDC section upgraded (new Event manager and IR control), Device features are highlighted and examples presented, Send message sections added, FW upgrade process , New document template introduced	Laszlo Zsedenyi
2.1	14-06-2016	Firmware upgrade process corrected	Laszlo Zsedenyi
2.2	09-02-2017	TPS mode table corrected, Port status command description corrected, Factory EDID list corrected, Minor typos corrected.	Laszlo Zsedenyi
2.3	04-07-2017	Safety-related section updated	Laszlo Zsedenyi
3.0	11-12-2017	New template format, add model denomination, add standard rack installation, add connecting steps, LCD menu structure diagram, new screenshots in LDC chapter, add system commands, send message commands and update port status explanation in LW3 progref. chapter, add troubleshooting chapter, add audio wiring guide in the appendix.	Judit Barsony
3.1	31-10-2018	1080p120Hz signal support info added	Judit Bársony
3.2	22-11-2018	General updates, updated LW3 programmer's reference chapter	Tamas Forgacs
3.3	13-03-2020	Firmware upgrade process changed, LDU2 SW introduced.	Laszlo Zsedenyi

Contact Us

sales@lightware.com

+36 1 255 3800

support@lightware.com

+36 1 255 3810

Lightware Visual Engineering LLC.
Peterdy 15, Budapest H-1071, Hungary

www.lightware.com

©2020 Lightware Visual Engineering. All rights reserved. All trademarks mentioned are the property of their respective owners. Specifications subject to change without notice.