



Savant® SmartControl 3 Wireless Controller

SSC-W003I-01

Deployment Guide

Document Number: 009-1518-00

Document Date: January 2018

Document Supports: da Vinci 8.5 and higher

Contents

To access the link to the topics in this document, click the topic page.



Important Safety Information - Read First	3
Safety Statements	3
1. Introduction.....	4
2. Deployment Checklist	4
3. Box Contents and Specifications	4
4. Front and Rear Panel Descriptions	5
5. Mounting.....	6
6. Connections and Wiring	7
7. Provisioning to Local Network	8
8. Blueprint Configuration	11
9. Additional Information.....	13
Appendix A: Network Requirements	14
Appendix B: Provision Controller Using Embedded Web UI.....	15
Appendix C: System Monitor	17
Important Notice.....	18

Important Safety Information - Read First



Before installing, configuring, and operating Savant equipment and other vendor equipment, Savant recommends that each dealer, installer, etc. access and read all the required technical documentation. Savant technical documentation can be located by visiting Savant.com. Vendor documentation is supplied with the equipment.

Read and understand all safety instructions, cautions, and warnings in this document and the labels on the equipment.

Safety Classifications In this Document

Note:	Provides special information for installing, configuring, and operating the equipment.
 IMPORTANT!	Provides special information that is critical to installing, configuring, and operating the equipment.
 CAUTION!	Provides special information for avoiding situations that may cause damage to equipment.
 WARNING!	Provides special information for avoiding situations that may cause physical danger to the installer, end user, etc.

Electric Shock Prevention

 ELECTRIC SHOCK!	The source power poses an electric shock hazard that has the potential to cause serious injury to installers and end users.
 ELECTRICAL DISCONNECT:	The source power outlet and power supply input power sockets should be easily accessible to disconnect power in the event of an electrical hazard or malfunction.

Weight Injury Prevention

 WEIGHT INJURY!	Installing some of the Savant equipment requires two installers to ensure safe handling during installation. Failure to use two installers may result in injury.
---	--

Safety Statements

Follow all the safety instructions listed below and apply where relevant. Additional safety information will be included where appropriate.

1. Read these instructions.
2. Keep these instructions.
3. Heed all warnings.
4. Follow all instructions.
5. Do not use this apparatus near water.
6. Clean only with dry cloth.
7. Do not block any ventilation openings. Install in accordance with the manufacturer's instructions.
8. Do not install near any heat sources such as radiators, heat registers, stoves, or other apparatus (including amplifiers) that produce heat.
9. Do not defeat the safety purpose of the polarized or grounding-type plug. A polarized plug has two blades with one wider than the other. A grounding type plug has two blades and a third grounding prong. The wide blade or the third prong is provided for your safety. If the provided plug does not fit into your outlet, consult an electrician for replacement of the obsolete outlet.
10. Protect the power cord from being walked on or pinched particularly at plugs, convenience receptacles, and the point where they exit from the apparatus.
11. Only use attachments/accessories specified by the manufacturer.
12. Use only with the cart, stand, tripod, bracket, or table specified by the manufacturer, or sold with the apparatus. When a cart is used, use caution when moving the cart/apparatus combination to avoid injury from tip over.
13. Unplug this apparatus during lightning storms or when unused for long periods of time.
14. Refer all servicing to qualified service personnel. Servicing is required when the apparatus has been damaged in any way, such as power supply cord or plug is damaged, liquid has been spilled or objects have fallen into the apparatus, the apparatus has been exposed to rain or moisture, does not operate normally, or has been dropped.
15. To completely disconnect this equipment from the AC mains, disconnect the power supply cord plug from the AC receptacle.

1. Introduction

This Deployment Guide will aid an installer through the process of installing, configuring, and adding a SmartControl 3 (SSC-W003I-01) wireless controller to a Savant Pro System. Read through this document in its entirety before beginning the installation process. To begin, ensure that the following items are available:

- SmartControl 3 Smart Wireless Controller (SSC-W003I)
- iOS Device with SmartConnect installed.....
-  **HELPFUL!** The SmartConnect application runs on most iOS devices (iPad, iPhone, iPod Touch) and simplifies the provisioning process. If an iOS device is not available, the SmartControl 3 controller can be provisioned using the embedded web UI. See [Appendix B: Provision Controller Using Embedded Web UI](#) for information on this.
- Unique ID (UID) of the SSC-W003I
Unique ID is available on sticker on bottom of controller.
- Savant Development Environment (SDE/MacBook®)
RacePoint Blueprint da Vinci 8.5 or higher.
- Network meeting Savant requirements
See [Appendix A: Network Requirements](#)
- SSID and Passphrase for Wi-Fi Router or Switch to the local network

2. Deployment Checklist

This page can be used as a checklist to record which steps have been completed.

- 1. Review Front and Rear Panel Descriptions
See [Front and Rear Panel Descriptions](#)
- 2. Mounting and Wiring
See [Mounting](#)
See [Connections and Wiring](#)
- 3. Provision Controller to the Network.....
See [Provision to Local Network](#)
- 4. Add SCC-W003I-01 to an existing RacePoint Blueprint Configuration
See [Blueprint Configuration](#)
See [Save Configuration, Generate Services, and Upload Configuration](#)





3. Box Contents and Specifications

For Box Contents and Specifications, refer to the SmartControl 3 Wi-Fi Controller Quick Reference Guide (009-1504-xx) located on the **Savant Customer Community**.

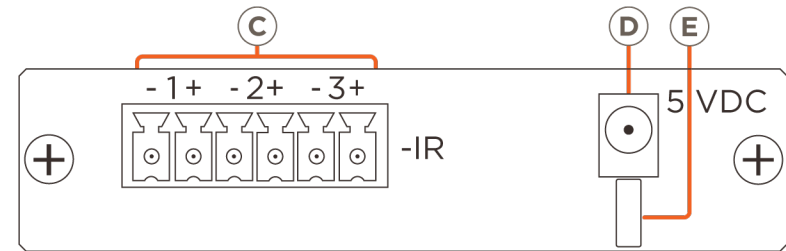
4. Front and Rear Panel Descriptions

It is important to read and understand the information in this section before beginning the installation process. Understanding the various states of the Status LED as well as the requirements of each port are an important part of the installation process.

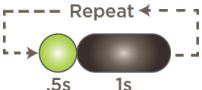
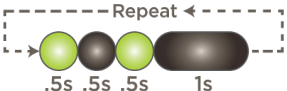
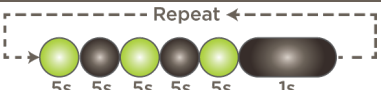

A	Reset	Press and hold for five seconds while powered; then release. The Status LED will begin blinking rapidly when reset is complete. After the reset, the controller will be in Provisioning Mode. See Rapid Blink below.
	Off	 No power applied. Power supply may not be plugged in.
	Solid Green	 The Controller is provisioned to local network and communicating with the Savant Pro System Host. This is normal operation mode.
	Blinks Once	 Is in Provisioning Mode and ready to be added to the local network.
	Blinks Twice	 Establishing a connection with the local Savant Pro System Host.
B	Blinks Three Times	 Provisioned to the local network and trying to connect to the Savant Pro System Host.
	Short Off Blink	 Firmware is updating.
	Rapid Blink	 The reset button on the front panel was held down for at least five seconds and the controller is performing a factory reset. After the reset, all network settings are cleared and the factory defaults are restored.
C	IR	Used to send IR signals to devices that have an IR input or can receive IR signals via an IR flasher (5V tolerant only). See the IR Wiring section below for important precautions regarding IR functionality before making connections.
D	Input Power	5V DC 1.2A - Use the included power supply.
E	Cable Lance	Use with included cable tie to secure power supply connection.

5. Mounting

Mount the controller in a place that is dry, well ventilated, and out of direct sunlight.

5.1. Mounting Plate Installation

The mounting plate available in the shipping box can mount the controller to a wall or existing structure. Follow instructions below to mount the controller.

1. Place the mounting plate onto a wall so the tabs that hold the controller are oriented horizontally.
2. Mark on the wall the two mounting holes. Install wall anchors and screw the mounting plate to the wall.
3. Snap the controller into the bracket so the tabs on the bracket seat into the slots on the side of the controller.

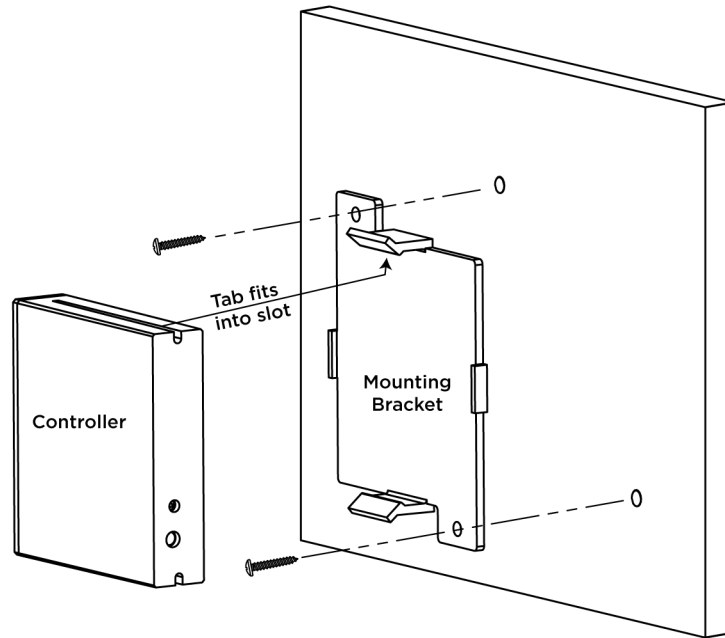

5.2. Rack or Cabinet Installation

When mounting in a rack or cabinet, the controller should be set on a solid, flat, level surface.

6. Connections and Wiring

Use the information below to make both the control and power connections.

6.1. IR Wiring

IR connections are made using a 6-pin screw down plug-in connector supplied with the controller. The stripped wire slips into the rear of the connector and the screws are used to lock the wire in hole.

⚠ IMPORTANT! Read precautions below before proceeding!

- IR emitters must be installed 15 feet (4.6 meters) or less from the equipment being controlled.
- Use of 3rd party flashing IR emitters with Talk Back is not recommended. These types of emitters can draw voltage away from the IR signal which degrades the IR performance.

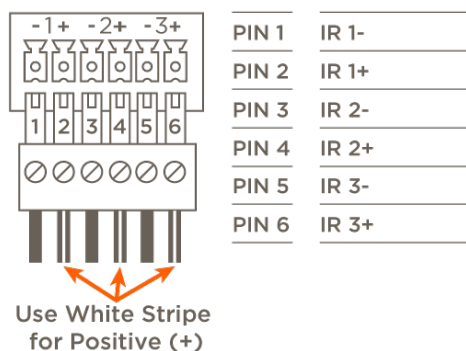

To connect wires into terminal block connector:

1. Remove power if power is applied.
2. Pull to remove the connector from the rear of the controller.
3. With a small flat bladed screwdriver, turn the screws on the top of connector counterclockwise until the silver crimps in the front open enough to slide the wire into the square slot.
4. Strip the ends of each wire to ¼ inch. Using the diagram to the left, insert the stripped wires into the proper slots.
5. Turn the screws clockwise until the screw tightens around each wire. Tug on the wire a bit to verify it is installed securely. There should no bare wires protruding from the rear of the connector.
6. Plug terminal block back into the rear of the controller.

6.2. Power and Network Connection

Connect the provided power supply between the 5V DC connection on the rear of the controller and a surge protected 120 - 240V AC 50/60Hz outlet receptacle. The SSC-W003I-01 communicates with the network over the local Wi-Fi network so a wired connection between the controller and the network is not required.

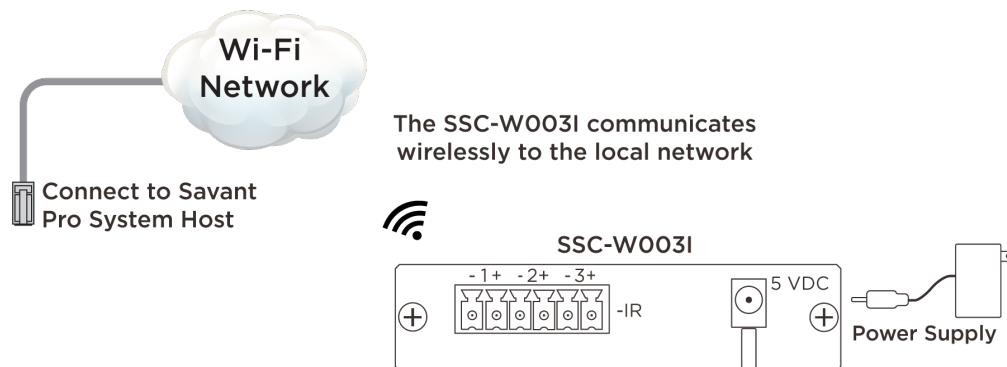

ℹ HELPFUL! No Ethernet connection is needed. The controller communicates with the Savant Pro System Host over the local Wi-Fi network.

7. Provisioning to Local Network

The controller communicates with the Savant Pro System Host over the local Wi-Fi network. The diagram below demonstrates the provisioning process. Review the diagram for an understanding on how the process works.

7.1. Network Diagram (Provisioning Process)

The diagram below demonstrates the provisioning process. Review the diagram for an understanding on how the process works.

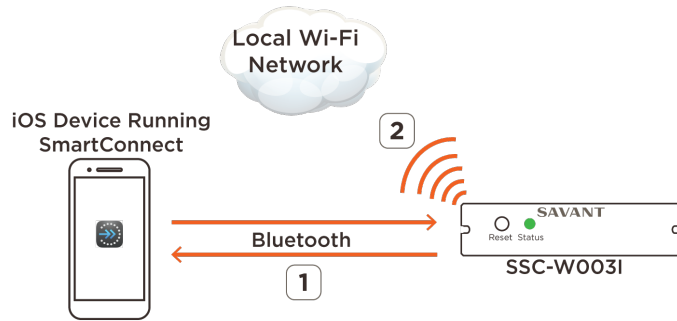

1. During the provisioning process, the SmartConnect application communicates with the controller using Bluetooth signaling.
2. Once the controller is provisioned, it can now communicate using the local Wi-Fi network.

HELPFUL!

- Savant recommends using DHCP reservation. Refer to the owner's manual for the local router for information on setting DHCP reservations.
- 802.11r (fast roaming) is not supported. If using a router that supports fast roaming, it should be disabled.

7.2. Checklist for Provisioning

The following items are required to provision the controller using the SmartConnect application.

- SSC-W003I SmartControl 3 wireless controller
- iOS Device with SmartConnect App (v1.6 or higher) installed
- Network SSID and passphrase for the wireless router or switch in local network
- Unique ID (UID) of the controller (obtained from sticker located on bottom of controller).....
- Optional:** rpmEmbScanner (Used to access the IP Address of the controller)

7.3. SSID Guidelines

Savant Wi-Fi products can connect to a wireless network that meet the following SSID guidelines.

- Maximum SSID Length 32 characters
- Maximum Passphrase Length WPA/WPA2: 8-50 characters
- WEP: 10-26
- Wireless Standard 802.11 a/b/g/n (2.4 or 5 GHz)

Supported SSID and Passphrase special characters.

!	#	@	\$	%	^	&	*	()	-	_	`	~		
=	+	'	:	;	?	/	.	<>	[]	{	}		,	\

7.4. Install SmartConnect

To connect the controller to the network, the Savant SmartConnect application must be installed and running on an iOS device such as an iPhone® or iPad®. The SmartConnect Application can be downloaded from the Apple App Store to your iPhone or iPad.

- From the Apple App Store search for Savant Systems LLC.
- Locate the SmartConnect App and download/install onto your iOS device.

For more information, refer to the **SmartConnect Reference Guide (009-1046-xx)** located on the **Savant Customer Community**.



HELPFUL INFORMATION!

- SmartConnect v1.6 or higher is required to provision the SSC-W003I-01.
- The iOS device that the SmartConnect application is running on does not need to be connected to the same network the controller is being added to.
- SmartConnect is only supported on the iOS platform. Refer to [Appendix B: Provision Controller Using Embedded WebUI](#) for instructions on how to connect the controller to the local network if the SmartConnect application is not available.
- During the provisioning process, the SSC-W003I must be within 30 feet of the device running the SmartConnect app.
- The iOS device must be running Bluetooth v4.0 or higher.

7.5. Provision Instructions

1. If not already powered, plug the provided power supply and cable between the controller and a surge protected 100 – 240V AC receptacle. Refer to the [Power and Network Connections](#) section above.
2. By default, a new SSC-W003I controller is set at the factory, to be in provisioning mode. If the Status LED is blinking the **Blinks Once** sequence, **skip this step**. If, however, the LED is blinking a different sequence, follow the bulleted items below to set the controller to provisioning mode.
 - Press and hold the reset button for five seconds until the Status LED blinks green rapidly, then release.
 - After the reboot (1 – 2 seconds), the Status LED will begin the Blinks Once sequence. The Blinks Once sequence indicates it is in provisioning mode and ready to be added to the local network.
3. On the iOS device (iPhone, iPad, etc.), tap the SmartConnect (Connect) icon .
4. Locate the **SSC-W003i** in the **Devices on Bluetooth** section. Record the Savant ID (UID) displayed. This UID will be used later in this procedure.

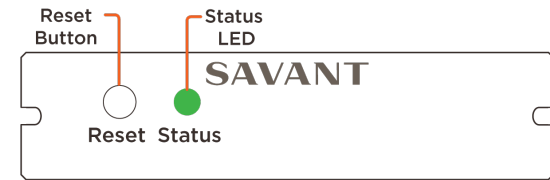

5. Tap the SSC-W003I entry from the **Devices on Bluetooth** section of the App.

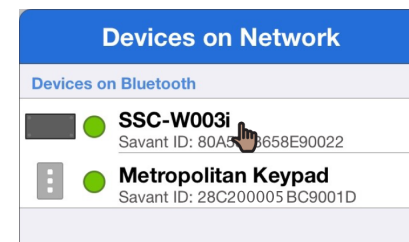

6. In the **Pick a Network** window that opens, tap **Join Other Network...** (image not shown).
7. Populate the **Name** field with the SSID of the local Wi-Fi network.
- or -
Select the **Use Current Network SSID** field. Select this field only if the iOS device that the SmartConnect App is running on, is connected to the same network the Savant Pro System Host is communicating with.
8. Tap **Choose** from the Security field and select the security configured on the local network.
9. Enter the password to the local network into the **Password** field.
10. Tap **Join** when complete.

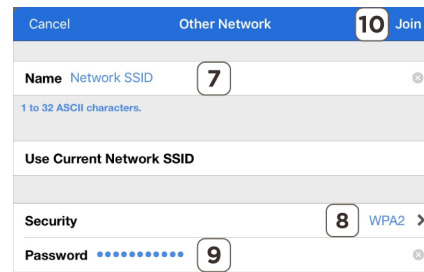

11. A **Provisioning Success** window will open informing the user the device is provisioned.



HELPFUL INFORMATION!

- The SSC-W003I will now be listed in the **Devices on WiFi** section in SmartConnect if the iOS device is connected to the same local network that the controller just got added to.
- With the SSC-W003I provisioned, the Status LED will blink one of the images below.

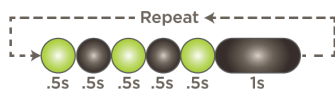
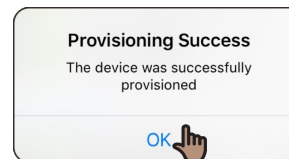

Blinks Three times - The controller is provisioned to the local network and trying to connect to the Savant Pro System Host. The controller needs to be added to a Blueprint configuration and the configuration uploaded to the Host. Follow the steps in the **Blueprint configuration** section below to do this.

Solid Green - The controller is communicating with both the local network and the Savant Pro System Host. The configuration running on the Host already has this controller in its configuration.

- If the IP Address for the controller is needed (i.e. for DHCP reservations or troubleshooting), the IP Address of the controller can be discovered using the **rpmEmbScanner** utility located under the **Launch** menu of the Savant Application Manager (SAM).

8. Blueprint Configuration

The instructions below add the SSC-W003I controller to a Blueprint configuration. Once added to a configuration, it can then be uploaded to the Savant Pro System Host.

8.1. Add SSC-W003I to Blueprint

1. Open the Savant Application Manager (SAM).
2. Through SAM, open a RacePoint Blueprint configuration.
3. Select **Show Library** from the Blueprint toolbar to open the Components library.
4. Enter **SSC-W003I** into the Search bar (see image to right).

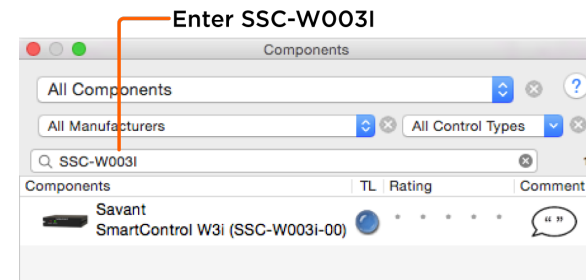

5. Drag the SSC-W003I into either a shared equipment or user zone.

HELPFUL INFORMATION! Placing a component in the Shared Equipment zone ensures that it will be accessible from any zone in the Savant Pro App. Placing a component in a user zone limits its availability to only that zone.

6. In the window that opens, enter a unique name that describes the component being added.
7. Select **Create**

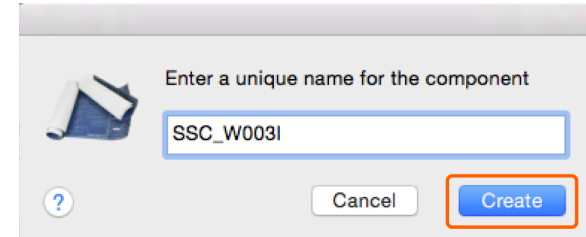

8. Drag the controller into the layout window.
9. Close the Component library by selecting **Hide Library** from the Blueprint toolbar.
10. Double-click the controller to open the Inspector.
11. Enter the 16 character UID for the controller into the **Savant UID** field. This is the UID obtained in step 4 of the [Provision Instructions](#) section above.

TIP! The UID can also be obtained from the sticker located on the bottom of the SSC-W003I controller.

12. Close the Inspector.
13. In Blueprint, make a connection between the IR ports on the controller and the IR ports of the devices being controlled. The profiles for these devices can be found in the RacePoint Blueprint Component Library.



8.2. Save Configuration, Generate Services, and Upload Configuration

With the controller added and the Blueprint Configuration complete, the configuration needs to be uploaded to the Savant Pro System Host. Follow steps below to do this.

1. Select **File > Save** from the Blueprint menu bar.
2. Select the **Generate Services** icon from the Blueprint toolbar and answer the prompts. The State icon in the RacePoint Blueprint toolbar will change to either blue or green indicating the services for the configuration are created.

 **HELPFUL INFORMATION!** If this is a new configuration and the **Generate Services** icon is not accessible (grayed out), add a **Generic Network Switch** to the configuration and connect the **Wifi (Ethernet)** port on the SSC-W003I to an **Ethernet Port** on the Network Switch. This will make the Generate Services icon active.
3. **OPTIONAL:** Select **Update All UI Screens > Sync with Services** (only if necessary) from the Blueprint toolbar to sync any user interfaces such as an iPad® to the services. The State icon will change to green when complete.

4. Select the **Upload to Master** icon from the Blueprint toolbar to upload the configuration to the Savant Pro System Host. Answer any prompts that may open.

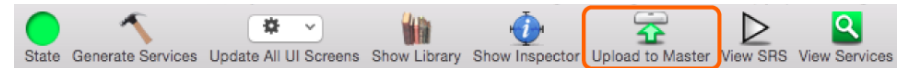

Select Upload to Master

5. The System Monitor application will automatically open as displayed to the right. Verify the path to the configuration file is correct. Select **Upload** when satisfied.

The configuration will now upload to the Host. Once uploaded, the Host can now communicate with the controller. The Status LED on the controller will illuminate solid green indicating it is communicating with the Host.

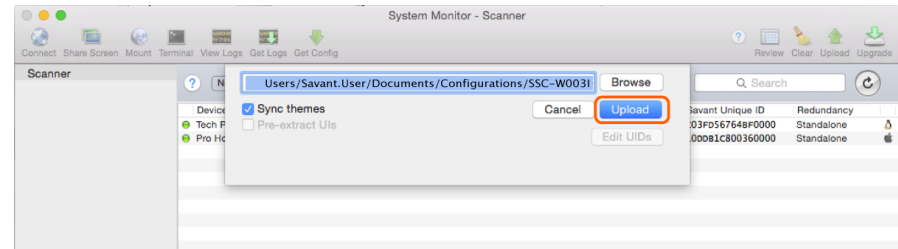

9. Additional Information

Refer to the following documents located on the **Savant Customer Community** for additional information.

- SSC-W0031-01 Quick Reference Guide (009-1504-xx)
- Smart Connect Reference Guide (009-1049-xx)
- Savant Application Manager (SAM) Reference Guide (009-1382-xx).
- System Monitor Reference Guide (009-1421-xx).
- Review the following Video from Savant Community > Savant University > Course Catalog > Controllers.
 - 7.0 Savant Controllers Family.

Appendix A: Network Requirements

Savant requires the use of business class/commercial grade network equipment throughout the network to ensure the reliability of communication between devices. These higher quality components also allow for more accurate troubleshooting when needed.

Device Network Connections

Connect all Savant devices to the same local area network (LAN) or subnet as the Host. Savant recommends not implementing any type of traffic or packet shaping in your network topology for the Savant devices as this may interfere with performance.

Managing IP Addresses

To ensure that the IP Address will not change due to a power outage, a static IP Address or DHCP reservation should be configured. Savant recommends using DHCP reservation within the router. By using this method, static IP Addresses for all devices can be managed from a single UI avoiding the need to access devices individually. Setting DHCP reservation varies from router to router. Refer to the documentation for the router to configure DHCP reservation.

Network Changes

Savant recommends performing one of the following steps to refresh the IP connection after connecting to a new network, changing routers, or if the IP Address range is changed in the current router. This will reset any IP connection and ensure that the Host is communicating with the network correctly.

To refresh the IP connection, do the following:

- **Restore System Defaults**

To restore system IP default settings, press and hold the reset button for 5 seconds until the Status LED starts a rapid blinking sequence; then release. System will reset and IP Address settings will be cleared.

Appendix B: Provision Controller Using Embedded Web UI

The steps below describe how to provision the SSC-W003I-01 to the local network using the embedded Web UI. All SSID and Passphrase guidelines described in Section 7.3 above also pertain to the process below.

1. Apply Power and Clear Network Settings

1. Apply power by plugging the provided power supply between the 5V DC connection on the rear of the controller and a surge protected 120 – 240 V AC outlet.
2. Press and hold the reset button on the front panel for five seconds until the Status LED on front panel of the controller begins a **Rapid Blinking** sequence; then release. The controller will reboot (1-2 seconds) and return to its factory default settings and the Status LED on the front panel will blink once a second indicating it is in provisioning mode. Refer to the LED status **Blinks Once** for more information. The controller is now ready to be provisioned to the local network.

2. Connect to Network.

1. On the MacBook/SDE, select the Wi-Fi icon  from the menu bar and then select the controller from the available networks. The controller will be presented as **Savant<mac address>**.

Note: The Mac Address is the first 12 characters of the UID. The UID is printed on a sticker on the bottom of the controller.

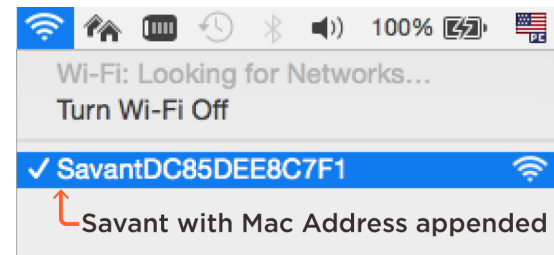

2. Open a browser and enter IP Address 192.168.1.1.
3. Select **Provisioning** from the web page that opens.

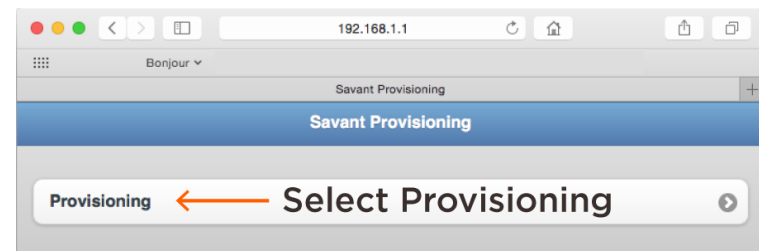

- Select the network from the list of available networks.

Optional: If the network is not displayed in the list of available networks, select **Other SSID** and enter the network SSID manually.

- Follow the prompts and enter the passphrase for the network selected.

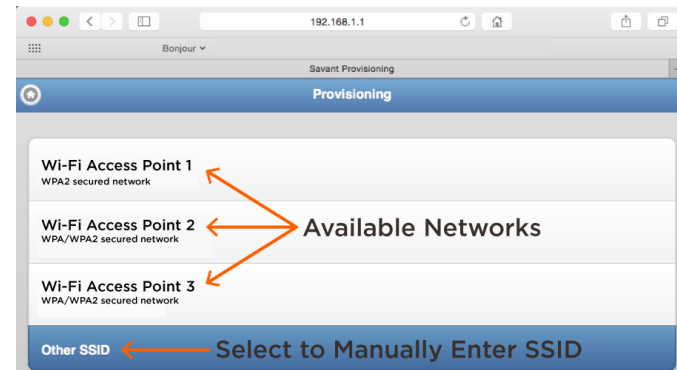

- The controller will join the specified local network and a **Settings Applied** message will appear. Read and understand the statement in this window.
- The Status LED will now blink one of the sequences described below

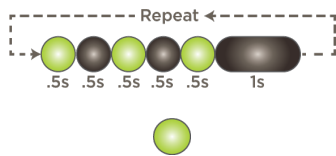
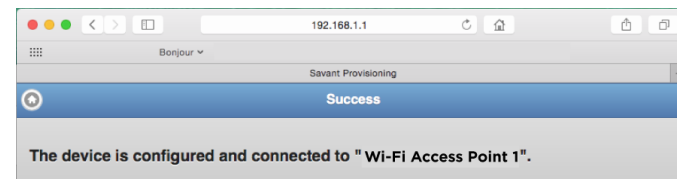

Blinks Three times - The controller is connected to the local network and trying to connect to the Savant Pro System Host. In this scenario, the controller needs to be added to a Blueprint configuration and uploaded to the Host. Follow the steps in the **Blueprint Configuration** section above to do this.

Solid Green - The controller is communicating with both the local network and with the Savant Pro System Host. The configuration running on the Host already has this controller in its configuration.

- The controller is now connected to the local network. If required, the next step is to configure the controller into **RacePoint Blueprint**.

HELPFUL! Once the controller is provisioned and assigned an IP Address, the SDE/MacBook will automatically disconnect from the controller. At this point, the SDE/MacBook will no longer be connected to a wireless network. If network connectivity is required, the user will need to reconnect to the local network.

Appendix C: System Monitor

The System Monitor application is a tool that allows a user the ability to inspect, monitor, and make updates to the components in the Savant Pro System. As part of the Savant Pro System, the SSC-W003I is one of those components available in System Monitor. Relevant System Monitor information regarding this controller is described below.

General Information

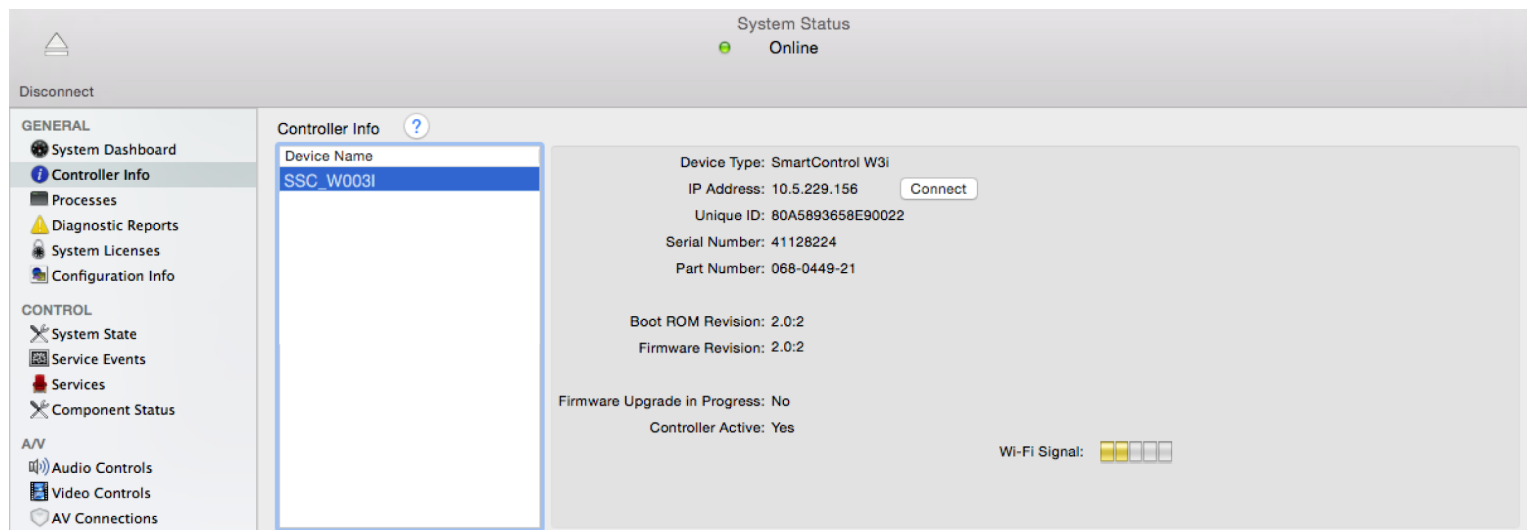

Device Type	Displays the product selected.
IP Address	IP Address assigned to the controller. Select the Connect button to open a terminal window into the device.
Unique ID	A 16-character Savant ID that identifies the controller to the Savant Pro System Host.
Serial Number	Serial Number assigned to the controller.
Part Number	The Savant part number assigned to the controller. The Savant Support Team may require this number during troubleshooting or if a replacement is required.
Boot ROM Revision	Version of Boot ROM running.
Firmware Revision	The revision of firmware running.
Firmware Upgrade in Progress	Displays the progress of a firmware download. Displays No if no update is happening.
Controller Active	Displays Yes when active and can be used in a Savant Pro System. Displays the state of the controller when not in the active state (e.g. rebooting)

Important Notice

Disclaimer

Savant Systems, LLC. reserves the right to change product specifications without notice, therefore, the information presented herein shall not be construed as a commitment or warranty.

Savant Systems, LLC. shall not be liable for any technical or editorial errors or omissions contained herein or for incidental or consequential damages resulting from the performance, furnishing, reliance on, or use of this material.

Patents

Certain equipment and software described in this document is protected by issued and pending U.S. and foreign patents.

All products and services are trademarks or registered trademarks of their respective manufacturer.

Copyright

This document contains confidential and proprietary information protected by copyright. All rights reserved. Copying or other reproduction of all or parts of this document is prohibited without the permission of Savant Systems.

Trademarks

© 2017 Savant Systems, LLC. All rights reserved. Savant, Savant App, Savant Host, Now You Can, RacePoint Blueprint, Single App Home, TrueCommand, TrueControl, and the Savant logo are trademarks of Savant Systems, LLC.

AirPlay, Apple, AirPort Express, AirPort Extreme, Apple TV, Apple Remote Desktop, FireWire, iMac, iTunes, iPad, iPad mini, iPad Air, iPhone, MacBook, Mac and OS X are trademarks or trade names of Apple Inc. iOS is a trademark of Cisco®. Android, Google, Google Play, and other Google marks are trademarks of Google, Inc. Wi-Fi is a registered trademark of the Wi-Fi Alliance®. HDMI® is a trademark of HDMI Licensing, LLC. Autonomic® and TuneBridge® are registered trademarks of Autonomic Controls, Inc. MOTU® is a registered trademark of Mark of the Unicorn, Inc. Luxul is a registered trademark of Luxul Wireless.

All other brand names, product names, and trademarks are the property of their respective owners.

Technical and Sales Support

Savant Systems, LLC is dedicated to providing prompt and effective support in a timely and efficient manner.

- To contact Savant Support, access the **Savant Customer Community** and enter a support Case ticket.
- To contact Savant Sales, visit Savant.com and select **Contact Us** to locate a local sales representative in your area.