

visual engineering
LIGHTWARE

User's Manual



VINX-120-HDMI-ENC
VINX-110-HDMI-DEC

VINX-210AP-HDMI-ENC
VINX-120AP-HDMI-ENC
VINX-110AP-HDMI-DEC
VINX-120AP-HDMI-ENC-DNT

AV Over IP Multimedia Extender

Important Safety Instructions

Class II apparatus construction.

The equipment should be operated only from the power source indicated on the product.

To disconnect the equipment safely from power, remove the power cord from the rear of the equipment, or from the power source. The MAINS plug is used as the disconnect device, the disconnect device shall remain readily operable.

There are no user-serviceable parts inside of the unit. Removal of the cover will expose dangerous voltages. To avoid personal injury, do not remove the cover. Do not operate the unit without the cover installed.

The appliance must be safely connected to multimedia systems. Follow instructions described in this manual.

Ventilation

For the correct ventilation and to avoid overheating ensure enough free space around the appliance. Do not cover the appliance, let the ventilation holes free and never block or bypass the ventilators (if any).

WARNING

To prevent injury, the apparatus is recommended to securely attach to the floor/wall or mount in accordance with the installation instructions. The apparatus shall not be exposed to dripping or splashing and that no objects filled with liquids, such as vases, shall be placed on the apparatus. No naked flame sources, such as lighted candles, should be placed on the apparatus.

Waste Electrical & Electronic Equipment WEEE

This marking shown on the product or its literature, indicates that it should not be disposed with other household wastes at the end of its working life. To prevent possible harm to the environment or human health from uncontrolled waste disposal, please separate this from other types of wastes and recycle it responsibly to promote the sustainable reuse of material resources. Household users should contact either the retailer where they purchased this product, or their local government office, for details of where and how they can take this item for environmentally safe recycling. Business users should contact their supplier and check the terms and conditions of the purchase contract. This product should not be mixed with other commercial wastes for disposal.

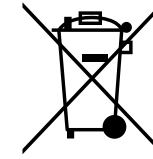

Caution: Laser Product



Common Safety Symbols

Symbol	Description
	Direct current
	Alternating current
	Double insulation
	Caution: for indoor use only
	Caution: possibility of electric shock
	Caution

Symbol Legend

The following symbols and markings are used in the document:

WARNING! Safety-related information which is highly recommended to read and keep in every case!

ATTENTION! Useful information to perform a successful procedure; it is recommended to read.

DIFFERENCE: Feature or function that is available with a specific firmware/hardware version or product variant.

INFO: A notice which may contain additional information. Procedure can be successful without reading it.

DEFINITION: The short description of a feature or a function.

TIPS AND TRICKS: Ideas which you may have not known yet but can be useful.

Navigation Buttons

 Go back to the previous page. If you clicked on a link previously, you can go back to the source page by pressing the button.

 Navigate to the Table of Contents.

 Step back one page.

 Step forward to the next page.

Document Information

All presented functions refer to the indicated products. The descriptions have been made during testing these functions in accordance with the indicated Hardware/Firmware/Software environment:

Item	Version
Firmware package version	2.0.1
Lightware Device Updater V2	2.3.0
Lightware Device Controller	1.34.2

Document revision: **v2.0**

Release date: **13-08-2020**

Editor: Laszlo Zsedenyi

About Printing

Lightware Visual Engineering supports green technologies and Eco-friendly mentality. Thus, this document is made for digital usage primarily. If you need to print out few pages for any reason, follow the recommended printing settings:

- Page size: A4
- Output size: Fit to page or Match page size
- Orientation: Landscape

TIPS AND TRICKS: Thanks to the size of the original page, a border around the content (gray on the second picture below) makes possible to organize the pages better. After punching the printed pages, they can be placed easily into a ring folder.

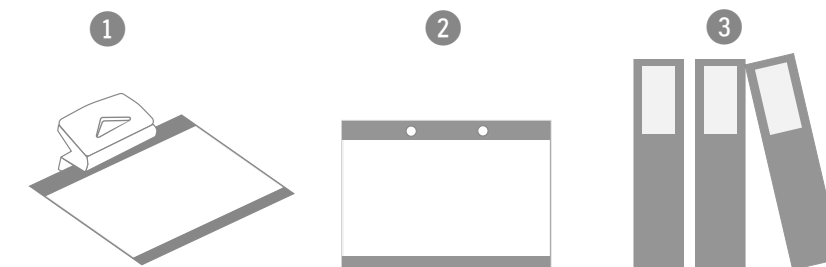

Hashtag (#) Keywords in the Document

This user's manual contains keywords with hashtag (#) to help you to find the relevant information as quick as possible.

The format of the keywords is the following:

#<keyword>

The usage of the keywords: use the **Search** function (Ctrl+F / Cmd+F) of your PDF reader application, type the # (hashtag) character and the wished keyword.

The **#new** special keyword indicates a new feature/function that has just appeared in the latest firmware or software version.

Example

#dhcp

This keyword is placed at the DHCP (dynamic IP address) setting in the front panel operation, the Lightware Device Controller (LDC) and the LW3 programmer's reference section. See the list of all hashtag keywords of the document in the [Hashtag Keyword List](#).

Table of Contents

1. INTRODUCTION	6	4.5. DANTE® AUDIO OUTPUT INTERFACE	32	6.3.7. Error Messages.....	52
1.1. DESCRIPTION	7	4.6. RS-232 INTERFACE	34	6.3.8. Escaping.....	52
1.2. BOX CONTENTS	8	5. SOFTWARE CONTROL OPTIONS	35	6.3.9. Signature	52
1.3. OPTIONAL ACCESSORIES	8	5.1. CONNECTION METHODS.....	36	6.3.10. Subscription.....	53
1.4. FEATURES OF THE DEVICE.....	9	5.2. CONNECTING VIA THE BUILT-IN WEB PAGE	36	6.3.11. Notifications about the Changes of the Properties	53
1.5. FURTHER FEATURES OF THE AP-SERIES	9	5.3. CONNECTING USING LIGHTWARE DEVICE CONTROLLER	36	6.4. SYSTEM COMMANDS	54
1.6. TYPICAL APPLICATIONS	10	5.3.1. Upgrading the LDC.....	36	6.4.1. Querying the Product Name	54
1.7. MODEL COMPARISON	11	5.3.2. Running the LDC.....	37	6.4.2. Setting the Device Label.....	54
2. PRODUCT OVERVIEW	12	5.4. MAIN SETTINGS (ENCODER)	38	6.4.3. Querying the Serial Number	54
2.1. VINX-120-HDMI-ENC.....	13	5.4.1. General Settings	38	6.4.4. Querying the Package Version.....	54
2.2. VINX-110-HDMI-DEC.....	13	5.4.2. Video Status and Settings.....	39	6.4.5. Resetting the Device.....	54
2.3. VINX-120AP-HDMI-ENC.....	14	5.4.3. Audio Settings	39	6.4.6. Restoring the Factory Default Settings	54
2.4. VINX-120AP-HDMI-ENC-DNT	15	5.5. MAIN SETTINGS (DECODER)	40	6.5. NETWORK CONFIGURATION	55
2.5. VINX-210AP-HDMI-ENC	16	5.5.1. General Settings	40	6.5.1. Querying the IP Address.....	55
2.6. VINX-110AP-HDMI-DEC.....	17	5.5.2. Video Status and Settings.....	41	6.5.2. Querying the IP Setup Mode (FW 2.x.x)	55
2.7. FRONT PANEL LEDs.....	18	5.5.3. Audio Settings	41	6.5.3. Setting the IP Setup Mode (FW 2.x.x)	55
2.8. RJ45 LEDs.....	18	5.6. CROSSPOINT MENU	42	6.5.4. Querying the DHCP State (FW 1.x.x)	55
2.9. FRONT PANEL BUTTONS	19	5.6.1. Frame Detector	42	6.5.5. Setting the DHCP State (FW 1.x.x)	56
2.10. DIP SWITCH.....	19	5.7. EDID MENU	43	6.5.6. Setting a Static IP Address	56
3. INSTALLATION	20	5.7.1. The EDID Memory Structure	43	6.5.7. Querying the Subnet Mask.....	56
3.1. MOUNTING OPTIONS	20	5.7.2. EDID Operations.....	43	6.5.8. Setting a Static Subnet Mask	56
3.1.1. VESA100 Mounting Adapter for Extenders.....	20	5.8. ADVANCED SETTINGS	44	6.5.9. Querying the Gateway Address	56
3.1.2. Rack Shelf Mounting	21	5.8.1. Common Settings (Encoder and Decoder)	44	6.5.10. Setting a Static Gateway Address.....	57
3.1.3. UD-kit Mounting.....	21	5.8.2. Decoder-related Settings	45	6.6. ENCODER-RELATED COMMANDS	57
3.2. MOUNTING INTO THE POWERED RACKMOUNT CAGE	22	5.8.3. LW3 Terminal	46	6.6.1. Querying the Input Video Signal Presence.....	57
3.2.1. Features	22	5.9. VIDEO WALL SETUP	47	6.6.2. Querying the Resolution of the Input Video Signal.....	57
3.2.2. Assembling Steps.....	22	5.9.1. Creating a Video Wall	47	6.6.3. Querying the Active Input Port.....	57
3.3. ELECTRICAL CONNECTIONS	23	5.9.2. Identify the Decoders	47	6.6.4. Querying the Video Input Selection Mode	58
3.4. CONNECTING STEPS	25	5.9.3. Gap and Bezel Settings	48	6.6.5. Setting the Video Input Selection Mode.....	58
3.4.1. Preparing the Network	25	5.9.4. Modifying a Video Wall	48	6.6.6. Querying the Video Quality Mode	58
3.4.2. Point-to-Multipoint Transmission (Multicast Mode)	25	5.9.5. Deleting a Video Wall	48	6.6.7. Setting the Video Quality Mode	58
3.4.3. Point-to-Point Transmission (Unicast Mode)	26	6. PROGRAMMER'S REFERENCE	49	6.6.8. Querying the HDCP State.....	59
3.4.4. Installation Checkpoints	26	6.1. OVERVIEW	50	6.6.9. Setting the HDCP State	59
4. DEVICE CONCEPT	27	6.2. INSTRUCTIONS FOR THE TERMINAL APPLICATION USAGE	50	6.7. DECODER-RELATED COMMANDS	59
4.1. VINX DEVICE CONCEPT	28	6.3. PROTOCOL RULES	50	6.7.1. Querying the Resolution of the Output Video Signal.....	59
4.2. VIDEO INTERFACE	28	6.3.1. The LW3 Tree Structure.....	50	6.7.2. Querying the Scaling Mode of the Output Video Signal.....	59
4.2.1. One-to-one Video Transmission (Unicast Mode)	29	6.3.2. The LW3 Command Structure.....	50	6.7.3. Setting the Scaling Mode of the Output Video Signal.....	59
4.2.2. One-to-All Video Transmission (Multicast Mode)	29	6.3.3. Legend for the Control Commands.....	51	6.7.4. Setting the Resolution of the Output Video Signal.....	60
4.2.3. Layout Examples	30	6.3.4. General Rules.....	51	6.7.5. Querying the Signal Type of the Output Video Signal	60
4.3. ANALOG AUDIO INTERFACE	31	6.3.5. Command Types.....	51	6.7.6. Setting the Signal Type of the Output Video Signal.....	60
4.4. USB INTERFACE	32	6.3.6. Prefix Summary	52	6.7.7. Querying the State of the USB Connection	60
				6.7.8. Establishing the USB Connection.....	60

6.8. AUDIO-RELATED COMMANDS.....	61	7.5. OPTION 2. – UPGRADING BY LDU2.....	75
6.8.1. Querying the Audio Input Selection Mode	61	7.5.1. Introduction.....	75
6.8.2. Setting the Audio Input Selection Mode	61	7.5.2. Preparation	75
6.8.3. Querying the Audio Signal Presence	61	7.5.3. About the Firmware Package (LFP2 File)	75
6.8.4. Analog Audio Input/Output Signal Level Settings	61	7.5.4. LDU2 Installation	75
6.9. SERIAL PORT SETTINGS.....	63	7.6. RUNNING THE SOFTWARE	76
6.9.1. Setting the Port Availability.....	63	7.7. THE UPGRADING STEPS	77
6.9.2. Setting the Baud Rate of the Port.....	63	7.8. IF THE UPGRADE IS NOT SUCCESFUL	79
6.9.3. Setting the RS-232 Port Mode	63	8. TROUBLESHOOTING	80
6.9.4. Setting the Data Bits.....	63	9. TECHNOLOGIES	82
6.9.5. Setting the Stop Bits.....	64	9.1. EDID MANAGEMENT.....	83
6.9.6. Setting the Parity	64	9.1.1. Understanding the EDID.....	83
6.10. ARRANGING THE EXTENDERS TO GROUPS.....	64	9.1.2. Advanced EDID Management.....	83
6.10.1. Querying the Working Mode (Unicast/Multicast).....	64	9.2. VIDEO OVER IP	84
6.10.2. Setting the Working Mode (Unicast/Multicast).....	64	9.3. HDCP MANAGEMENT	84
6.10.3. Querying the Video Stream ID Setting Method.....	65	9.3.1. Protected and Unprotected Content	84
6.10.4. Querying the DIP Switch Value	65	9.3.2. Disable Unnecessary Encryption	84
6.10.5. Querying the Video Stream ID	65	9.3.3. HDCP v2.2.....	85
6.10.6. DIP Switch Enable	65	9.4. RS-232 SIGNAL MANAGEMENT (VINX AP-SERIES).....	86
6.10.7. Setting the Video Stream ID.....	65	9.4.1. General Information	86
6.11. VIDEO WALL SETTINGS.....	66	9.4.2. Types of Serial Cables.....	86
6.11.1. Setting the Name of the Video Wall	66	9.4.3. Serial Device Types	86
6.11.2. Assigning a Decoder to a Video Wall	66	9.4.4. RS-232 Signal Transmission over VINX Devices	86
6.12. SETTING UP A VIDEO WALL (EXAMPLE)	67	10. APPENDIX	87
6.13. CROSSPOINT SWITCHING EXAMPLES	68	10.1. SPECIFICATIONS	88
6.13.1. Switching an Input to an Output.....	68	10.1.1. VINX Basic Series.....	88
6.13.2. Switching an Input to All Outputs.....	68	10.1.2. VINX AP-series	88
6.13.3. Switching the Source of a Video Wall	68	10.2. DELAY IN THE VIDEO TRANSMISSION.....	90
6.13.4. Multiple Switching.....	68	10.3. FACTORY DEFAULT SETTINGS.....	90
6.14. EDID MANAGEMENT (ENCODER).....	69	10.4. DIP SWITCH STATES	90
6.14.1. Querying the Emulated EDID.....	69	10.5. MECHANICAL DRAWINGS	91
6.14.2. Setting the Emulated EDID on the Input Port.....	69	10.6. OUTPUT RESOLUTIONS (SCALER)	92
6.14.3. Copying an EDID	69	10.7. AUDIO PORT NUMBERING	92
6.14.4. Querying the Preferred Resolution of an EDID.....	69	10.8. FACTORY EDID LIST.....	93
6.14.5. Deleting an EDID from the User Memory	70	10.9. FIRMWARE RELEASE NOTES	94
6.15. LW3 COMMANDS - QUICK SUMMARY	71	10.10. APPLICATION NOTE (LW-AN-001)	96
7. FIRMWARE UPGRADE	73	10.11. HASHTAG KEYWORD LIST	98
7.1. BUILT-IN WEB OR LDU2.....	74	10.12. FURTHER INFORMATION.....	99
7.2. IMPORTANT NOTICES – BEFORE STARTING THE UPGRADE	74		
7.3. ABOUT THE FIRMWARE PACKAGE (LFP/LFP2 FILE)	74		
7.4. OPTION 1. – UPGRADING VIA THE BUILT-IN WEB PAGE	74		
7.4.1. Firmware Upgrading Steps	74		

1

Introduction

Thank you for choosing Lightware's VINX Video Network Extender devices. In the first chapter we would like to introduce the device by highlighting the most important features in the below listed sections:

- ▶ DESCRIPTION
- ▶ BOX CONTENTS
- ▶ OPTIONAL ACCESSORIES
- ▶ FEATURES OF THE DEVICE
- ▶ FURTHER FEATURES OF THE AP-SERIES
- ▶ TYPICAL APPLICATIONS
- ▶ MODEL COMPARISON

1.1. Description

VINX-120-HDMI-ENC and VINX-110-HDMI-DEC are LAN-based Encoder/Decoder multimedia extenders to extend HDMI video from a local source to a remote sink. The Encoder and Decoder devices connect either via a direct CATx cable connection or through a Gigabit Ethernet Switch in between. The maximum delivery distance can reach up to 100 m with minimal latency and employing a quality, proprietary wavelet transform based image compression.

The maximum supported resolution is 3840 x 2160 @ 30Hz with 7.1 audio. The devices support both static and dynamic (DHCP) IP address settings. Pre-programmed factory EDID presets and user EDIDs are stored in the Encoder. DIP switches serve quick manual setting for device pairing over the network, a quick and easy installation method. Gap and bezel compensation can be adjusted for video walls. Scaling is available on the receiver side and videos can be freely cropped.

VINX AP-series

The VINX 'AP-series' is the second generation of the VINX family. These products extend the features of the first generation with the following functions: VGA input port, Analog audio (de)embedding and transmission over SFP modules. Furthermore, the devices can be powered over Ethernet (PoE).

VINX-120AP-HDMI-ENC-DNT

This variant contains a special module that allows de-embedding the audio of the incoming HDMI signal and transmitting as a 2-channel Dante® or AES67 source via the extra RJ45 connector. See more details in the [Dante® Audio Output Interface](#) section.



Dante® is a registered trademark of Audinate Pty Ltd.

Compatible Devices

The VINX AP-series devices are compatible with the VINX-120-HDMI-ENC and VINX-110-HDMI-DEC (basic VINX) devices. Please note that certain features are not available when mixing VINX-AP and basic VINX devices:

	Basic series	AP series
Video input port	HDMI	HDMI, VGA *
Analog audio (de)embedding	✗	✓
Return audio (mono) – in unicast mode	✗	✓
Dante® or AES67 audio de-embedding	✗	✓ **
Network interface	RJ45	RJ45, SFP
Powering modes	local	local, PoE

* VGA is available in VINX-210AP-HDMI-ENC model only.

** In VINX-120AP-HDMI-ENC-DNT model only.

See more details in the [Model Comparison](#) section.

Model Denomination

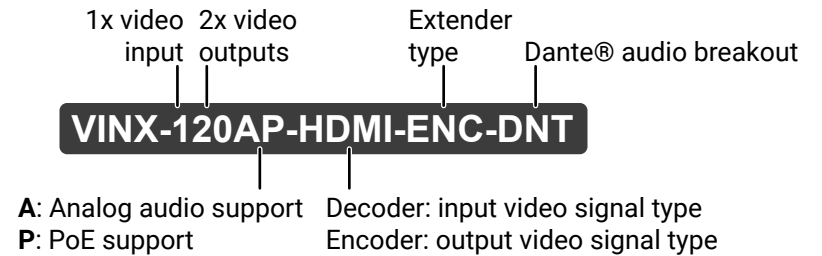





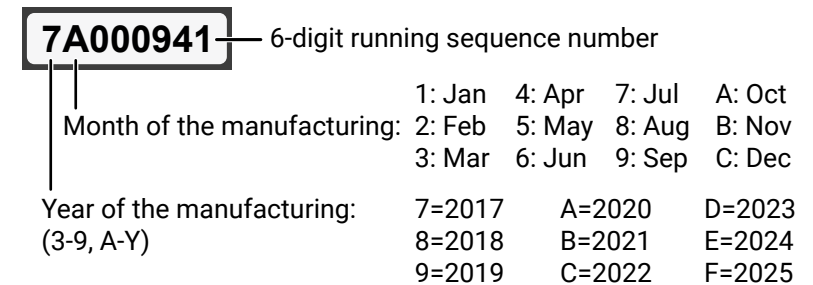

About the Serial Number

Lightware devices contain a label indicating the unique serial number of the product. The structure is the following:

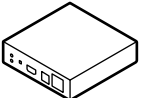

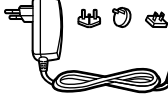
1.2. Box Contents

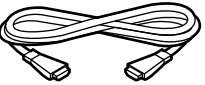
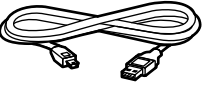
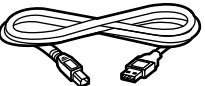
The following items are supplied in the box:

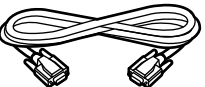
		VINX-110-HDMI-DEC	VINX-120-HDMI-ENC	VINX-110AP-HDMI-DEC	VINX-210AP-HDMI-ENC	VINX-120AP-HDMI-ENC	VINX-120AP-HDMI-ENC-DNT
	Encoder / Decoder device	✓	✓	✓	✓	✓	✓
	Safety and warranty info, Quick Start Guide	✓	✓	✓	✓	✓	✓
	5V DC adaptor	✓	✓	-	-	-	-
	12 DC adaptor	-	-	✓	✓	✓	✓
	Mounting screws (m3x4), 2 pcs.	✓	✓	✓	✓	✓	✓
	HDMI cable	-	✓	-	✓	✓	✓
	USB cable (mini B type to B type)	✓	✓	-	-	-	-
	USB cable (A type to B type)	-	-	-	✓	✓	✓
	Serial cable (DB9 male to RJ12)	-	✓	-	-	-	-
	Serial cable (DB9 female to RJ12)	✓	-	-	-	-	-
	Serial cable (DB9 male to female)	-	-	✓	✓	✓	✓

1.3. Optional Accessories

The following items can be purchased optionally for the indicated device:

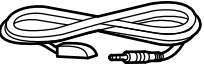
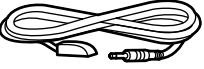
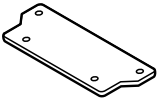
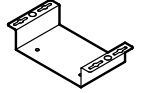
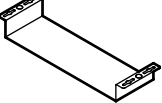
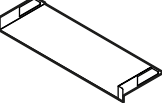
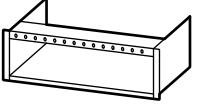
		VINX-110-HDMI-DEC	VINX-120-HDMI-ENC	VINX-110AP-HDMI-DEC	VINX-210AP-HDMI-ENC	VINX-120AP-HDMI-ENC	VINX-120AP-HDMI-ENC-DNT
	Infrared transmitter unit	-	✓	-	✓	✓	✓
	Infrared receiver unit	✓	-	✓	-	-	-
	VESA-100 compatible mounting adaptor	✓	✓	-	-	-	-
	UD-kit	✓	✓	-	-	-	-
	UD-kit double	✓	✓	✓	✓	✓	✓
	1U high rack shelf	✓	✓	✓	✓	✓	✓
	Powered rackmount cage (PRC-16-205)	✓	✓	-	-	-	-

The assembling of certain accessories can be found in the [Mounting Options](#) section.

1.4. Features of the Device

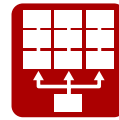

Video Wall Application

The VINX devices can be arranged to a Video wall up to 8x8 Display devices. The displayed video can be the same on each display, one image enlarged to all the sinks, or the mixture of these.



Supporting 4K Resolution

Up to HDMI 2.0 4K 2160p@60Hz 4:2:0 video input or 3840 x 2160 @ 30Hz resolution over a 1 Gigabit network with very low latency.



3D Signal Support

The extenders support the transmission of 3D content in 'Side-by-side' and 'Top-to-bottom' modes.



Advanced EDID Management

The user can emulate any EDID on the inputs independently, read out and store any attached monitor's EDID in the User memory locations, upload and download EDID files.

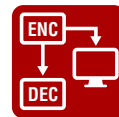

Local HDMI Output

A display device can be connected to the Encoder for local signal checking. The port carries the same video as the transmitted signal.



Frame Detector and Signal Analysis

The exact video and audio signal format can be determined such as timing, frequencies, scan mode, HDCP encryption, color range, color space and audio sample rate.



Image Adjustment

The extended video can be rotated or flipped at the Decoder side. Scaling is available at the Decoder side and videos can be freely cropped.



Built-in Website

Easy access from a web browser to control and configure the devices – even with a mobile device.

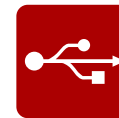

USB Extension

KVM extension for USB HID (Human Interface Devices, e.g. keyboard, mouse, presenter) and Mass Storage devices (Flash drive, Hard drive).



Serial Data Transmission

Transparent serial data transmission is available between the endpoints: Encoder and Decoder devices.

1.5. Further Features of the AP-series

Below mentioned features refer to the VINX-110AP-HDMI-DEC, VINX-120AP-HDMI-ENC and VINX-210AP-HDMI-ENC models only.

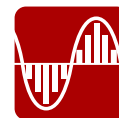

Analog Video Support

The extra VGA input port allows connecting analog video which is converted to digital signal.



Analog Audio Support

External analog audio signal can be embedded in the video stream at the Encoder side and can be de-embedded at the Decoder side.



SFP Module Support

The devices can be connected to the network switch over SFP modules.



Remote Power (PoE)

The devices can be Powered over Ethernet (according to IEEE 802.3af) by a compatible power source equipment.



Return Audio for a Microphone

Mono input port for a microphone from the Decoder towards the Encoder when the extender-pair is used in Unicast mode. Includes a 20 dB gain in the signal path.



Dante® or AES67 Audio De-embedding (VINX-120AP-HDMI-ENC-DNT only)

The audio of the HDMI signal can be transmitted as a 2-channel Dante® or AES67 source over the dedicated RJ45 connector.

1.6. Typical Applications

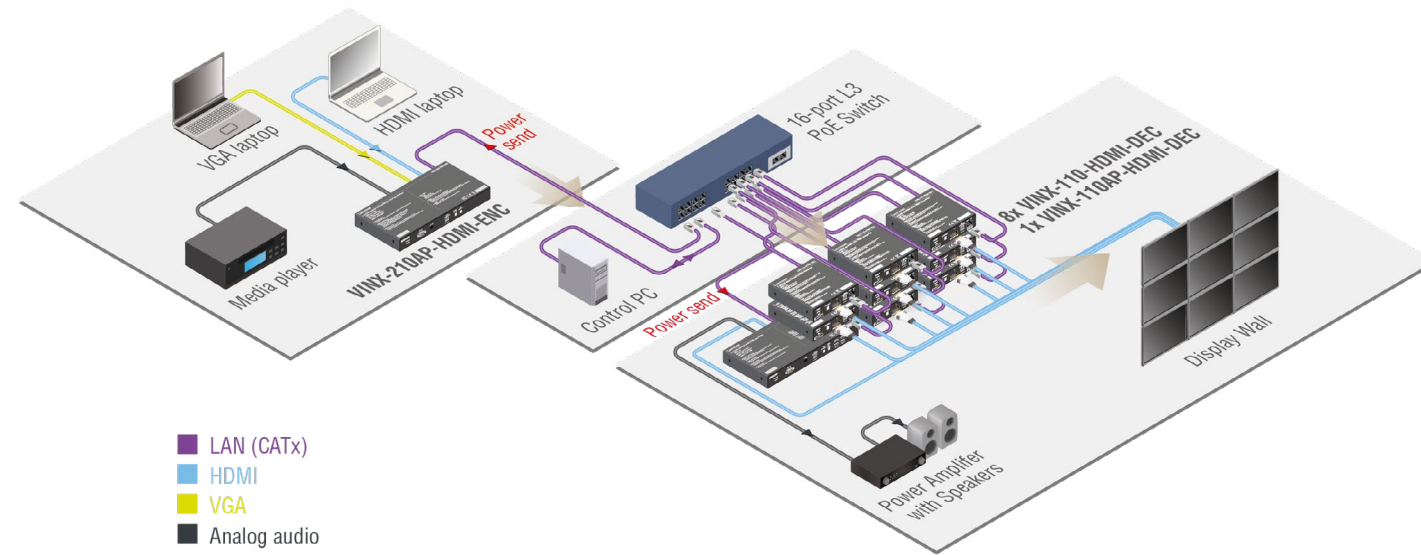

Video Wall Application (Multicast Mode)

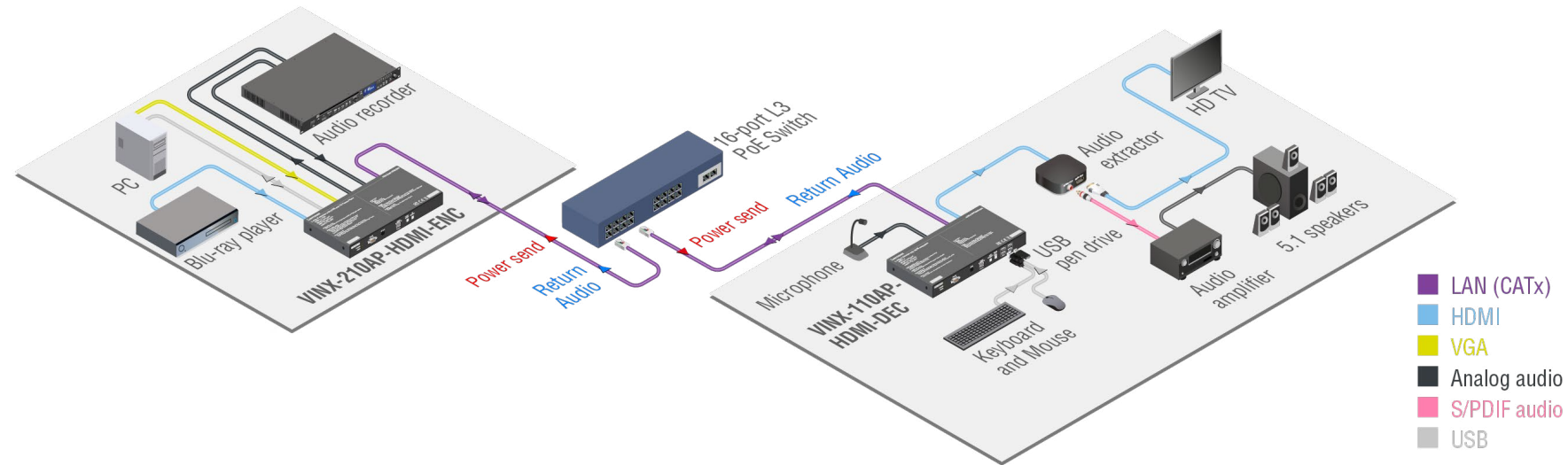

Simple Signal Extension (Unicast Mode)

1.7. Model Comparison

	Enclosure width		Power supply input			Inputs						Outputs				Control ports								
	1/4 RU	1/2 RU	5V DC	12V DC	PoE	HDMI	VGA	AV input		Analog audio	Microphone	HDMI	AV output		Dante® audio	Analog audio	RS-232			IR IN	IR OUT	USB type-A	USB mini-B	USB type-B
																	D-Sub9 female	D-Sub9 male	RJ12					
VINX-120-HDMI-ENC	✓	-	✓	-	-	✓	-	-	-	-	-	✓	✓	-	-	-	-	-	✓	-	✓	-	✓	-
VINX-110-HDMI-DEC	✓	-	✓	-	-	-	-	✓	-	-	-	✓	-	-	-	-	-	-	✓	✓	-	✓	-	-
VINX-120AP-HDMI-ENC	-	✓	-	✓	✓	✓	-	-	-	✓	-	✓	✓	✓	-	✓	✓	✓	-	-	✓	-	-	✓
VINX-120AP-HDMI-ENC-DNT	-	✓	-	✓	✓	✓	-	-	-	✓	-	✓	✓	✓	✓	✓	✓	✓	-	-	✓	-	-	✓
VINX-210AP-HDMI-ENC	-	✓	-	✓	✓	✓	✓	-	-	✓	-	-	✓	✓	-	✓	✓	✓	-	-	✓	-	-	✓
VINX-110AP-HDMI-DEC	-	✓	-	✓	✓	-	-	✓	✓	-	✓	✓	-	-	-	✓	✓	-	✓	-	✓	-	-	-

2

Product Overview

The following sections are about the physical structure of the device, input/output ports, connectors, status LEDs and front panel button functions.

- ▶ [VINX-120-HDMI-ENC](#)
- ▶ [VINX-110-HDMI-DEC](#)
- ▶ [VINX-120AP-HDMI-ENC](#)
- ▶ [VINX-120AP-HDMI-ENC-DNT](#)
- ▶ [VINX-210AP-HDMI-ENC](#)
- ▶ [VINX-110AP-HDMI-DEC](#)
- ▶ [FRONT PANEL LEDs](#)
- ▶ [RJ45 LEDs](#)
- ▶ [FRONT PANEL BUTTONS](#)
- ▶ [DIP SWITCH](#)

2.1. VINX-120-HDMI-ENC

Front and Rear View

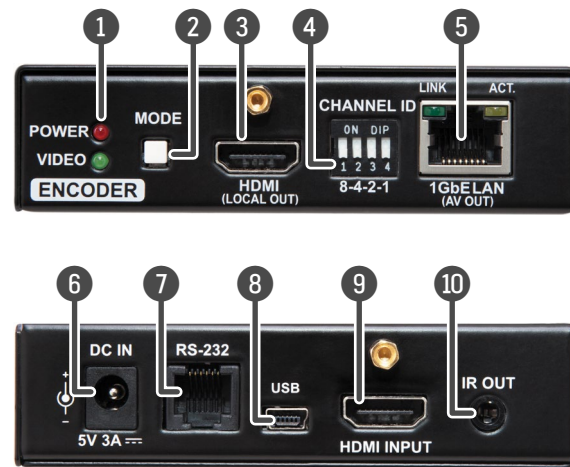

- ① **Status LEDs** See the [Front Panel LEDs](#) section.
- ② **Mode Button** **Short press:** switching between Video and Graphics modes.
Long press (more, than 10 seconds): reset to factory default settings.
- ③ **HDMI Output Port** Forwarding the same Audio / Video content as the AV Output Port.
- ④ **DIP Switch** Linking Encoder and Decoder devices; for more information see the [DIP Switch](#) section.
- ⑤ **AV Output Port** RJ45 connector for outgoing AV signal to the Decoder device or Network switch.
- ⑥ **DC 5V Input** 5V DC input for local power supply.
- ⑦ **RS-232 Port** RJ12 connector for transparent serial communication (point-to-point or point-to-multi point).
- ⑧ **USB Port** Mini B-type connector for USB pass-through (IP KVM) application.
- ⑨ **HDMI Input Port** Video port for DVI or HDMI signal.
- ⑩ **IR Output Port** IR signal output connector (for 3.5 mm Jack, 3-pole, TRS plug).

WARNING! Always use the supplied 5V power adaptor. Warranty void if damage occurs due to use of a different power source.

2.2. VINX-110-HDMI-DEC

Front and Rear View

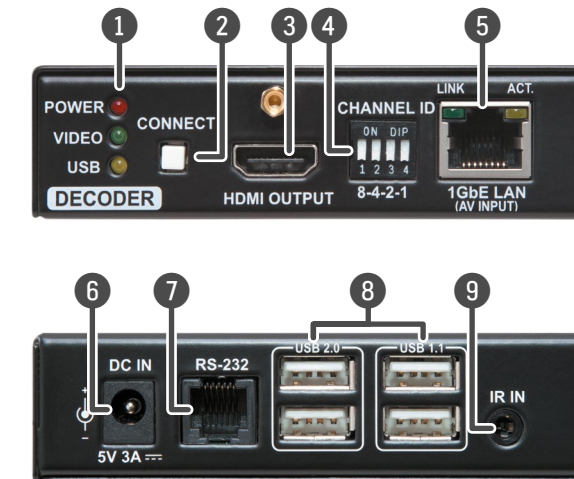

- ① **Status LEDs** See the [Front Panel LEDs](#) section.
- ② **Connect Button** **Short press:** acquire USB connection (this is required only in Multicast mode)
Long press (more, than 10 seconds): reset to factory default settings.
- ③ **HDMI Output Port** HDMI output to a sink device.
- ④ **DIP Switch** Linking Encoder and Decoder devices; for more information see the [DIP Switch](#) section.
- ⑤ **AV Input Port** RJ45 connector for incoming AV signal from the Encoder device or Network switch.
- ⑥ **DC 5V Input** 5V DC input for local power supply.
- ⑦ **RS-232 Port** RJ12 connector for transparent serial communication (point-to-point or point-to-multi point).
- ⑧ **USB Ports** USB 1.1 and 2.0 compatible A-type ports for transmitting USB HID and mass storage devices. USB 1.1 port can be used for changing the video stream by a keyboard, see the [Keyboard Shortcuts](#) section.
- ⑨ **IR Input Port** IR signal input connector (for 3.5 mm Jack, 3-pole, TRS plug).

2.3. VINX-120AP-HDMI-ENC

Front View

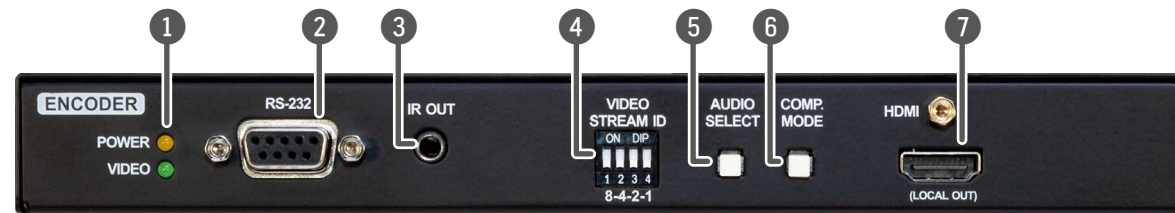

- | | | |
|---|--------------------------------|---|
| 1 | Status LEDs | See the Front Panel LEDs section. |
| 2 | RS-232 Port | D-SUB9 connector for transparent serial communication (point-to-point or point-to-multi point). |
| 3 | IR Output Port | IR signal output connector (for 3.5 mm Jack, 3-pole, TRS plug). |
| 4 | DIP Switch | Linking Encoder and Decoder devices (HW setting). |
| 5 | Audio Select button | Press the button to toggle between the following modes:
<div style="text-align: center;"> Auto → HDMI → Analog audio </div> |
| 6 | Compression Mode Button | Short press: switching between the Video and Graphics modes.
Long press (more, than 10 seconds): reset to factory default settings. |
| 7 | HDMI Output | For a local sink device (mirrored from the AV output). |

Rear View

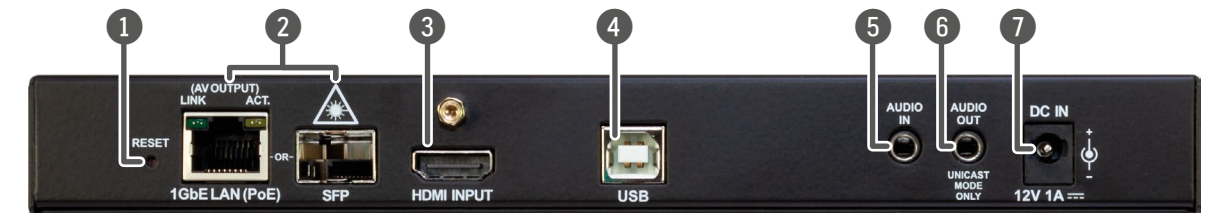

- | | | |
|---|--------------------------|---|
| 1 | Reset Button | Reboots the device. |
| 2 | AV Input Ports | RJ45 connector and slot for an SFP module. One at a time is available for receiving an AV signal. Please note that SFP module is not supplied with the device. |
| 3 | HDMI Input Port | Video port for DVI or HDMI signal. |
| 4 | USB Port | B-Type connector for USB pass-through application (e.g. for connecting the Encoder to a computer). |
| 5 | Audio Input Port | For unbalanced analog audio signal. |
| 6 | Audio Output Port | Presenting the audio signal coming from the Audio input port of the connected Encoder . This feature is available only in Unicast mode and if the Analog audio input is selected as an audio source on the Encoder . |
| 7 | DC 12V Input | 12V DC input for local power supply. |

2.4. VINX-120AP-HDMI-ENC-DNT

Front View

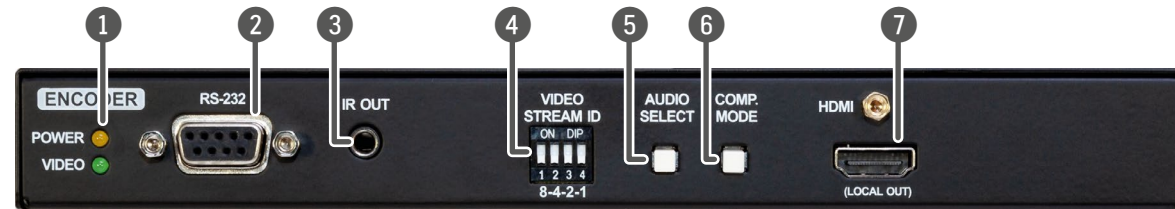

- | | | |
|---|--------------------------------|--|
| ① | Status LEDs | See the Front Panel LEDs section. |
| ② | RS-232 Port | D-SUB9 connector for transparent serial communication (point-to-point or point-to-multi point). |
| ③ | IR Output Port | IR signal output connector (for 3.5 mm Jack, 3-pole, TRS plug). |
| ④ | DIP Switch | Linking Encoder and Decoder devices (HW setting). |
| ⑤ | Audio Select button | Press the button to toggle between the following modes:
<div style="text-align: center;"> → Auto → HDMI → Analog audio → </div> |
| ⑥ | Compression Mode Button | Short press: switching between the Video and Graphics modes.
Long press (more, than 10 seconds): reset to factory default settings. |
| ⑦ | HDMI Output | For a local sink device (mirrored from the AV output). |

Rear View

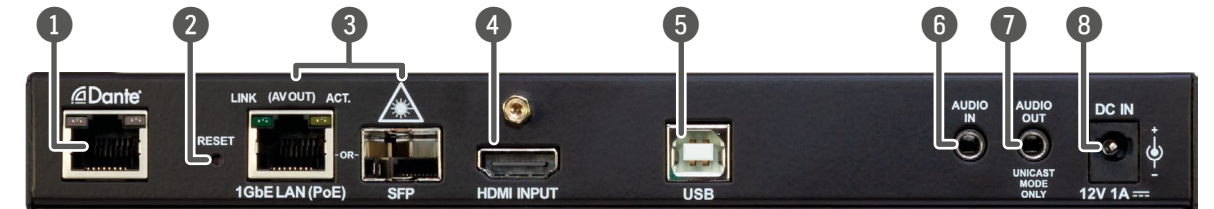

- | | | |
|---|----------------------------|---|
| ① | Dante® Audio Output | RJ45 connector for de-embedding the HDMI audio which can be transmitted as a 2-channel Dante® or AES67 source. |
| ② | Reset Button | Reboots the device. |
| ③ | AV Input Ports | RJ45 connector and slot for an SFP module. One at a time is available for receiving an AV signal. Please note that SFP module is not supplied with the device. |
| ④ | HDMI Input Port | Video port for DVI or HDMI signal. |
| ⑤ | USB Port | B-Type connector for USB pass-through application (e.g. for connecting the Encoder to a computer). |
| ⑥ | Audio Input Port | For unbalanced analog audio signal. |
| ⑦ | Audio Output Port | Presenting the audio signal coming from the Audio input port of the connected Encoder . This feature is available only in Unicast mode and if the Analog audio input is selected as an audio source on the Encoder . |
| ⑧ | DC 12V Input | 12V DC input for local power supply. |

2.5. VINX-210AP-HDMI-ENC

Front View

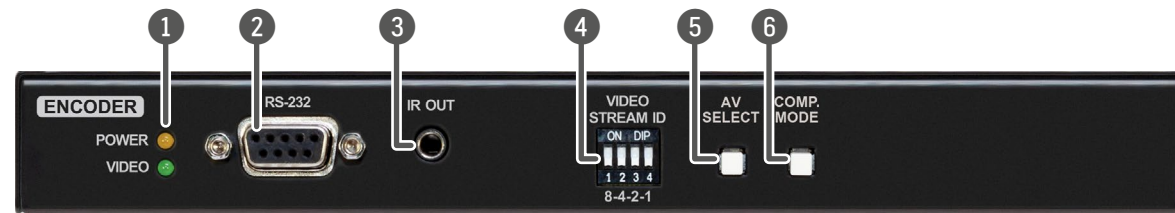

- | | | |
|----------|--------------------------------|--|
| 1 | Status LEDs | See the Front Panel LEDs section. |
| 2 | RS-232 Port | D-SUB9 connector for transparent serial communication (point-to-point or point-to-multi point). |
| 3 | IR Output Port | IR signal output connector (for 3.5 mm Jack, 3-pole, TRS plug). |
| 4 | DIP Switch | Linking Encoder and Decoder devices (HW setting). |
| 5 | AV Select Button | Press the button to toggle between the following modes:
<div style="text-align: center; margin: 5px 0;"> ↔ Auto → HDMI+Embedded audio ←
 ↔ VGA+Analog audio ← HDMI+Analog audio ← </div> See more details in the Front Panel Buttons section. |
| 6 | Compression Mode Button | Short press: switching between the Video and Graphics modes.
Long press (more, than 10 seconds): reset to factory default settings. |

Rear View

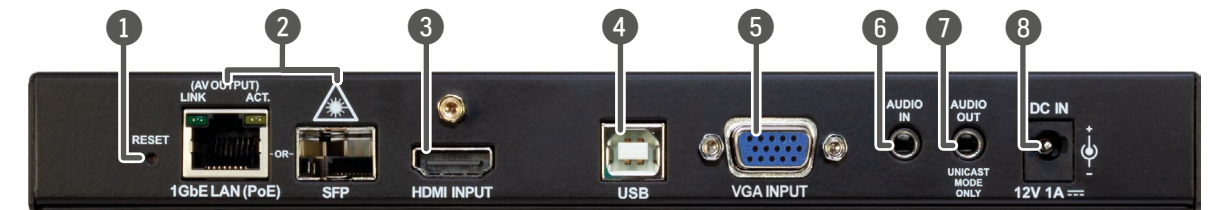

- | | | |
|----------|--------------------------|---|
| 1 | Reset Button | Reboots the device. |
| 2 | AV Input Ports | RJ45 connector and slot for an SFP module. One at a time is available for receiving an AV signal. Please note that SFP module is not supplied with the device. |
| 3 | HDMI Input Port | Video port for DVI or HDMI signal. |
| 4 | USB Port | B-Type connector for USB pass-through application (e.g. for connecting the Encoder to a computer). |
| 5 | VGA Input Port | Video port for analog VGA signal on VINX-120AP-HDMI-ENC. |
| 6 | Audio Input Port | For unbalanced analog audio signal. |
| 7 | Audio Output Port | Presenting the audio signal coming from the Audio input port of the connected Encoder . This feature is available only in Unicast mode and if the Analog audio input is selected as an audio source on the Encoder . |
| 8 | DC 12V Input | 12V DC input for local power supply. |

2.6. VINX-110AP-HDMI-DEC

Front View

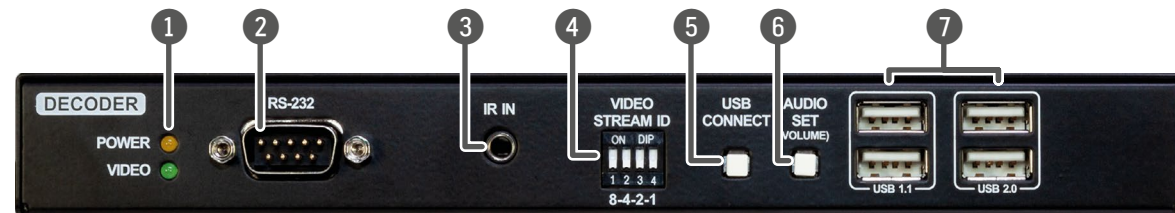

- | | | |
|---|---------------------------|--|
| ① | Status LEDs | See the Front Panel LEDs section. |
| ② | RS-232 Port | D-SUB9 connector for transparent serial communication (point-to-point or point-to-multi point). |
| ③ | IR Input Port | IR signal input connector (for 3.5 mm Jack, 3-pole, TRS plug). |
| ④ | DIP Switch | Linking Encoder and Decoder devices (HW setting). |
| ⑤ | USB Connect Button | Short press: acquire USB connection (this is required only in Multicast mode).
Long press (more, than 10 seconds): reset to factory default settings. |
| ⑥ | Audio Set Button | Short press: the analog audio output volume is increased by 10%.
Long press (more, than 5 seconds): the analog audio output volume is set to 0%. |
| ⑦ | USB Ports | USB 1.1 and 2.0 compatible A-type ports for transmitting USB HID and mass storage devices. USB 1.1 port can be used for changing the video stream by a keyboard, see the Keyboard Shortcuts section. |

Rear View

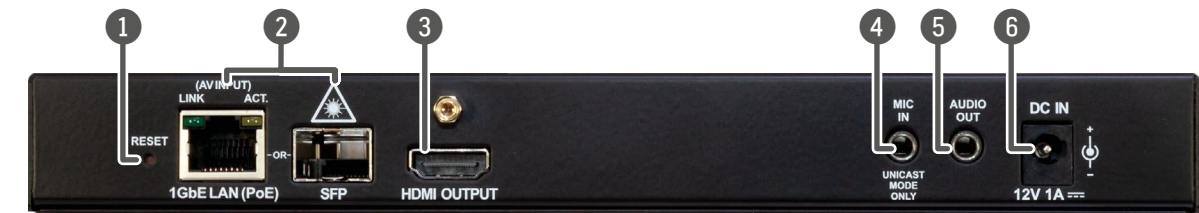

- | | | |
|---|--------------------------|---|
| ① | Reset Button | Reboots the device. |
| ② | AV Input Ports | RJ45 connector and slot for an SFP module. One at a time is available for receiving an AV signal. Please note that SFP module is not supplied with the device. |
| ③ | HDMI Output | HDMI output to a sink device on VINX-120AP-HDMI-DEC. |
| ④ | MIC Input Port | Mono input port for a microphone including +20 dB gain in the signal path. |
| ⑤ | Audio Output Port | Presenting the audio signal coming from the Audio input port of the connected Encoder . This feature is available only in Unicast mode and if the Analog audio input is selected as an audio source on the Encoder . |
| ⑥ | DC 12V Input | 12V DC input for local power supply. |

WARNING! The microphone input port applies a fixed bias to feed the connected electret (condenser) microphone. Thus it is not suitable for dynamic microphones which do not contain isolation or an impedance matching transformer. (Danger of damage of the microphone.)

2.7. Front Panel LEDs

INFO: However, the colors of the LEDs in the devices are different, the functions are the same.

POWER LED

- **OFF:** the device is not powered.
- **BLINKING:** booting is in progress.
- **ON:** the device is powered on.

VIDEO LED

- **OFF:** there is no network connection.
- **BLINKING:** the device is connected to a network but there is no video stream in progress.
- **ON:** the device is connected to a network and video stream is in progress.

USB LED (only in Decoders)

- **OFF:** there is no USB transmission between the Encoder and the Decoder.
- **ON:** the USB transmission is active between the Encoder and the Decoder.

POWER and VIDEO LEDs (only in Encoders)

- **BLINKING together:** there is a Video Stream ID clash in the network, e.g. another Encoder is set to the same Video Stream ID.

2.8. RJ45 LEDs

AV In/Out

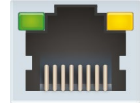
		Left LED, Green	Right LED, Yellow
	Blinking	Activity	Activity
	ON	10 Mbps	1000 Mbps

Dante® Audio Out

LED state	Left LED	Right LED	Function
	Off	Off	No power
	Solid green	Solid red	Dante is booting
	Blinking green	Solid green	Slave with sync (normal operation)
	Blinking green	Blinking green	Clock master (normal operation)
	Blinking green	Blinking red	Acquiring clock sync (normal operation)
	Alternating red/green	Alternating red/green	Identify (blinking for 6 seconds)
	Blinking red	Blinking red	Dante fail safe
	Blinking amber	Blinking amber	Device is upgrading

#new

2.9. Front Panel Buttons

Audio Select Button #button

Toggle between the following modes:

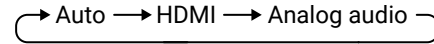

Auto: the Analog audio input port is selected when a plug is connected.

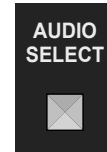

Mode and Compression Mode Buttons

- **Short press:** switching between the Movie and Graphics modes.
- **Long press** (more, than 10 seconds): reset to factory default settings.

When the network bandwidth is not enough to transmit the video signal, the following modes are available in the Encoder:

- **Movie mode** (Lower image quality @ Less bandwidth): The image quality is adjusted to the available bandwidth. If the bandwidth is decreased the image quality will be lower, but the video streaming is continuous.
- **Graphics mode** (Best image quality @ High bandwidth): The image quality is kept at a high level. If the bandwidth is decreased the image quality does not change, but frame drop may appear.

The setting has an affect when the available bandwidth is less than required.

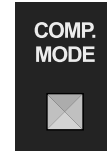

AV Select Button

Toggle between the following modes:

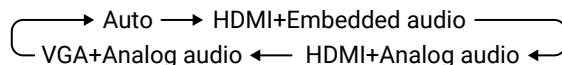

- **Auto mode:** the first connected source shall remain active as long as signal is present on the respective input. If sync is lost for at least 3 seconds, it will be switched over to the other source. No automatic switch back to the original input takes place when the signal is restored.

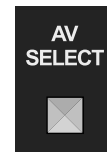

Connect and USB Connect Buttons

When the button is pressed for less, than ten seconds, the USB connection is acquired. This is necessary only in Multicast mode; when Unicast mode is active the assignment is arranged automatically.



Audio Set Button

- **Short press:** the analog audio output volume is increased by 10%.
- **Long press** (more, than 5 seconds): the analog audio output volume is set to 0%.

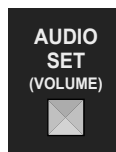

2.10. DIP Switch

The DIP switch can be used to set the Video Stream ID manually (HW setting). The interpretation of the DIP switch values can be found in the [DIP Switch States](#) section; please see the examples below:

DIP Switch State	Video Stream ID		/SYS/MB/GPIO. DipSwitch value
	Set by	Value	
	SW setting	see the built-in web	0x0
	HW setting	1	0x1
	HW setting	8	0x8

#led #dipswitch #videostreamid #streamid

3

Installation

The chapter is about the installation of the device and connecting to other appliances, presenting also the mounting options and further assembly steps.

- ▶ [MOUNTING OPTIONS](#)
- ▶ [MOUNTING INTO THE POWERED RACKMOUNT CAGE](#)
- ▶ [ELECTRICAL CONNECTIONS](#)
- ▶ [CONNECTING STEPS](#)

3.1. Mounting Options

WARNING! For fixing the device to a Rack shelf, use the screw supplied with the extender. Longer screw may touch internal parts and harm the device.

3.1.1. VESA100 Mounting Adapter for Extenders

DIFFERENCE: VESA100 Mounting Adapter can be used with the quarter-rack sized VINX extenders.

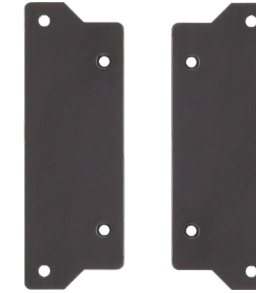

Mounting under the Desk

Two pieces of the adapter is needed for this kind of mounting. Fasten the adapters to the bottom of the extender and the desk as shown in the figure:

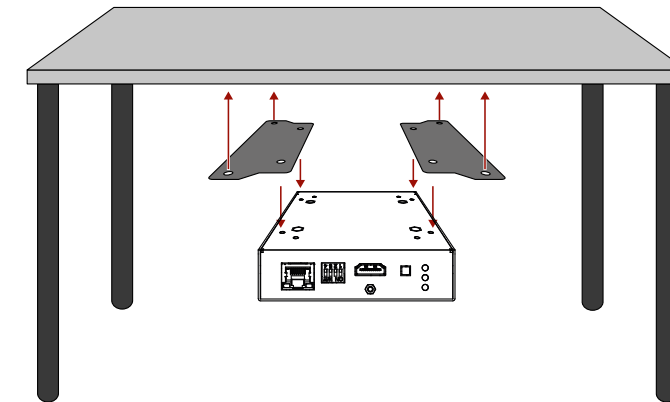

Mounting to a Display Device

Two mounting holes can be found on the bottom of the extender at each side, the VESA-compatible accessory plate can be fixed as indicated. The other two holes of the plate can be fixed to a VESA-compatible device (e.g. rear panel of an HDTV).

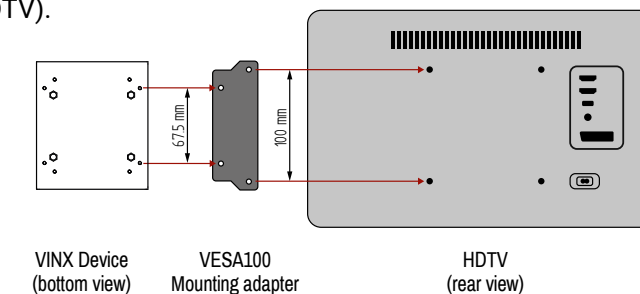

3.1.2. Rack Shelf Mounting

WARNING! For fixing the device to a Rack shelf, use the screw supplied with the extender. Longer screw may touch internal parts and harm the device. *#new*



The 1U high rack shelf provides mounting holes for fastening four VINX devices and put them into a standard rack cabinet (width of the Rack shelf is 448 mm – without the ears). Fix the device to the Rack shelf as shown in the figure:

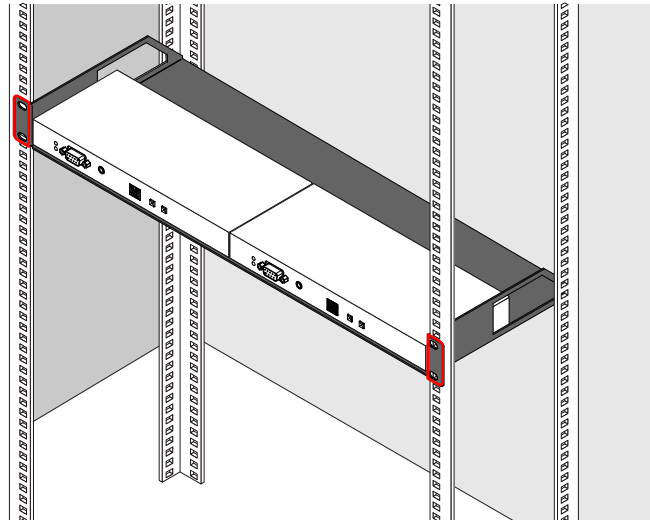

3.1.3. UD-kit Mounting

WARNING! For fixing the device to a Rack shelf, use the screw supplied with the extender. Longer screw may touch internal parts and harm the device. *#new*

Mounting with UD-kit double (Under Desk Double)



INFO: The fixing method is the same in case of UD-kit (for a quarter-rack sized device).

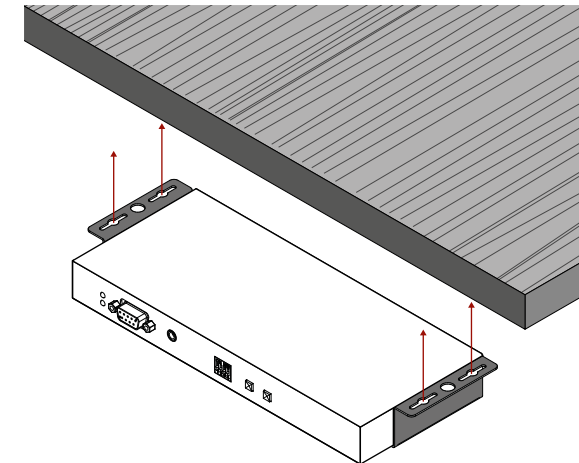

3.2. Mounting into the Powered Rackmount Cage

DIFFERENCE: Only the VINX-110-HDMI-ENC and VINX-120-HDMI-DEC devices are compatible with the PRC-16-205 Rackmount Cage.



The PRC-16-205 rackmount cage can be used to install up to 16 VINX devices in the same cabinet.

3.2.1. Features

- 16 slots for VINX devices in any combination.
- Built-in power supply unit for the devices.
- Easy to install as the cage is rack mountable: 3U-high, 1U-wide.
- The built-in blowers ensure the proper ventilation and airflow.
- The structure of the cage allows different arrangements not only for VINX devices.

For further information please see the Quick Start Guide of the [Rackmount Cage](#).

3.2.2. Assembling Steps

Step 1. Assembling the extender bracket.

Fasten the mounting bracket (highlighted with grey) onto the bottom of the extender with the provided M3x5mm PH flat head black screws (2 pcs./bracket) with a PH1 screwdriver.

Required screw:



M3x5, PH, flat head, black

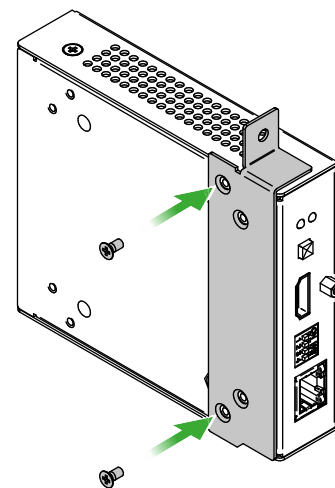

Step 2. 5V DC power cable connection.

Pull out the 5V DC power cable (highlighted with grey) belongs to the desired slot from the enclosure and connect it to the power connector of the extender.

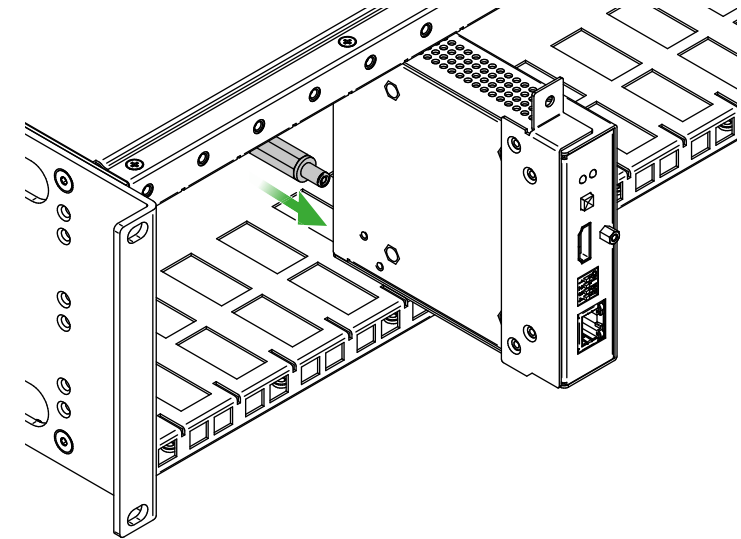

Step 3. Fastening the extender in the mounting slot.

Place the extender (highlighted with grey) to the desired mounting slot and fasten the extender bracket with 1 pc M4x8mm PH, D head unpainted screw with a PH1 screwdriver. Pay attention to the guide rails of the cage when placing the extender.

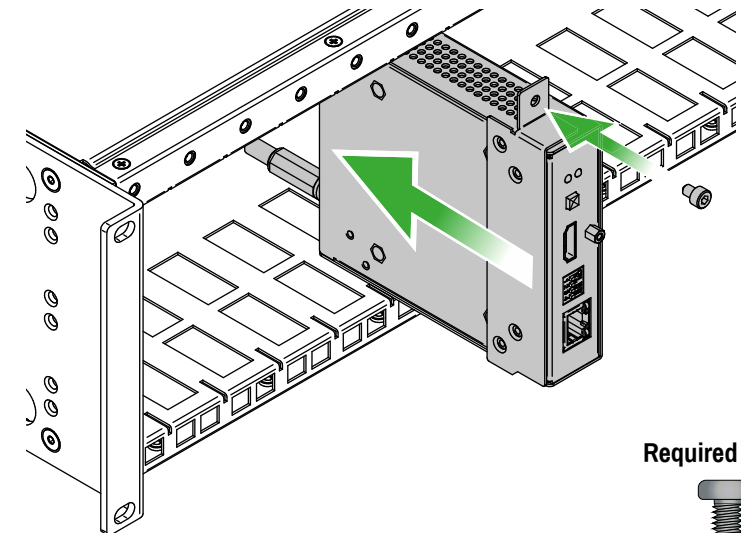

Required screw:

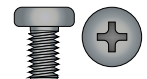

M4x8, PH, D head, unpainted

Step 4. Assembly of the Rack Ears and the Cable Guides.

The structure of the rack ears and the cable guides allow three kinds of installations in the Powered Rackmount Cage. The rack ears (highlighted with **blue**) are assembled to the front side in foremost position. Two cable guides (highlighted with **green**) are assembled to the device, one is to the front side in the middle position, the second one is to the rear side in lower position.

INFO: Below example is recommended if you have a deep rack and you need cabling on the front and the rear side as well.

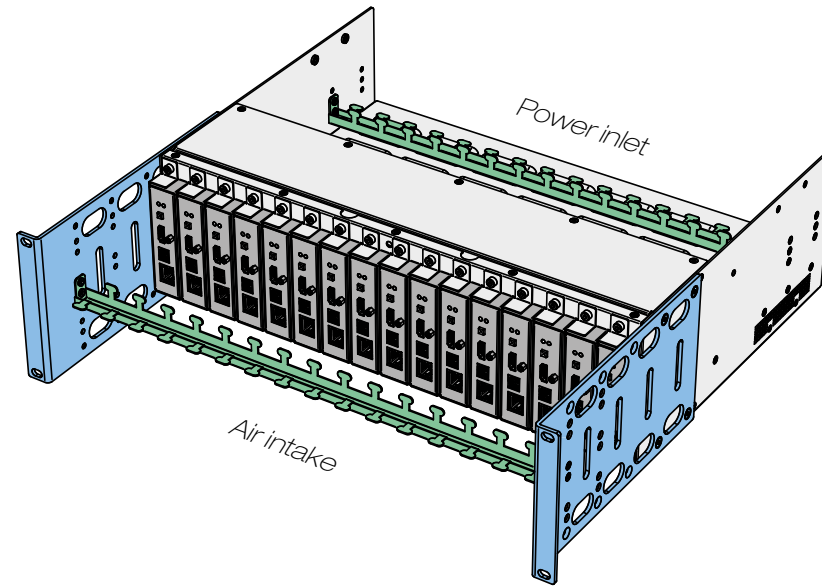

Other Compatible Devices

The rackmount cage is compatible with other Lightware extenders, too:

- HDMI-OPT-TX100
- HDMI-OPT-TX100R
- HDMI-OPT-TX200R
- HDMI-OPT-RX100
- HDMI-OPT-RX100R
- HDMI-OPT-RX200R
- HDMI-3D-OPT-RX150RA

3.3. Electrical Connections

1 GbE LAN and Dante® Audio Out

The devices provide standard RJ45 connectors for outgoing/incoming Video/Control signals. Always use high quality Ethernet cable for connecting Encoders and Decoders.

INFO: The connector type and the applied cable is the same for the Dante® audio output.

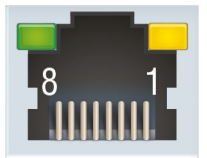

The Wiring of the Twisted Pair Cables

The recommended termination is based on TIA/EIA T 568 A or TIA/EIA T 568 B standards:

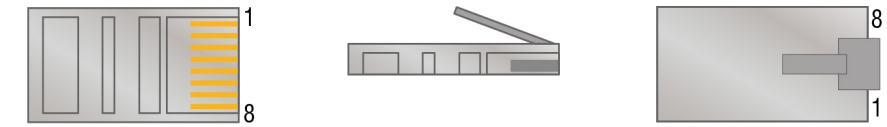

Pin	TIA/EIA T568A	Wire color	TIA/EIA T568B	Wire color
1		white/green		white/orange
2		green		orange
3		white/orange		white/green
4		blue		blue
5		white/blue		white/blue
6		orange		green
7		white/brown		white/brown
8		brown		brown

HDMI Input and Output Ports

The devices are assembled with standard 19-pole HDMI connectors for inputs and outputs. Special HDMI cables can be fastened to the housing by the nut.



USB Ports

The USB ports allow USB extension. The Encoders are assembled with USB B or mini-B type port (connecting a computer), and the Decoder devices contain two USB 1.1 and two USB 2.0 compatible A-type port. For more information about the USB extension see the [USB Interface](#) section.



Dante® is a registered trademark of Audinate Pty Ltd.

SFP Slots

The module inserted in the SFP slot can be used for network connection (AV transmission). Please note that SFP module is not supplied with the product.

DEFINITION: The small form-factor pluggable (SFP) is a compact, hot swappable optical module transceiver used for both telecommunication and data communication applications. It is a popular industry format jointly developed and supported by many network component vendors. The SFP interface supports data rates up to 1 Gbit/s. *

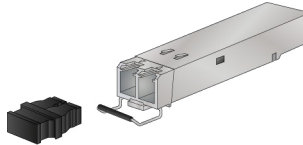

ATTENTION! Please note that only one of the network port is available at the same time in a device: either the SFP or the RJ45. Using both connectors at the same time results unknown outcome.

* Source: https://en.wikipedia.org/wiki/Small_form-factor_pluggable_transceiver

Maximum Allowed Optical Cable Length

The maximum allowed optical cable length depends on the installed SFP modules. Always check the specification of the optical modules before the fiber optical cabling.

Analog Audio Ports

DIFFERENCE: Below mentioned connectors can be found only on the AP-series' devices.

Input and Output Ports

The connectors are used for receiving/sending unbalanced analog audio signal. They are also known as (3.5 mm or approx. 1/8") audio jack, phone jack, phone plug and mini-jack plug.

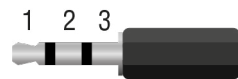

Pin no.	Signal
1	Left
2	Right
3	Ground



Jack audio plug pin assignments

ATTENTION! The input is noise-sensitive. Applying an unearthed audio source or using a Dual Transformer/ Isolator (DTI) device is highly recommended.

ATTENTION! Do not connect a headphone to the Audio output port.

Microphone Input Port (Return Audio)

Mono input port for microphones including +20 dB gain in the signal path (compared to the forward audio signal level). If this input is connected to a powered equipment hum noise issue may occur. This case an isolation transformer (a passive DI box) can help.



ATTENTION! The microphone input port applies a fixed bias to feed the connected electret (condenser) microphone. Thus it is not suitable for dynamic microphones which do not contain isolation or an impedance matching transformer. (Danger of damage of the microphone.)

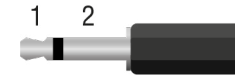

Pin no.	Signal
1	Signal
2	Ground



Microphone audio plug pin assignments

RS-232 Port

The Basic VINX-series

The quarter rack-sized devices contain a standard RJ12 connector which is used for RS-232 serial connection. The port can be used to connect serial devices by the supplied serial cables.

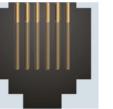

The AP-series

The half rack-sized devices contain a standard D-sub9 connector for RS-232 serial connection. The pinout of the connectors are different as follows:

VINX-120AP-HDMI ENC VINX-210AP-HDMI-ENC		VINX-110AP-HDMI-DEC
DCE unit		DTE unit
Tx data	Pin #2	Rx data
Rx data	Pin #3	Tx data
Ground	Pin #5	Ground

Please see the [Dante® Audio Output Interface](#) section for more details about the practical usage and the [RS-232 Signal Management \(VINX AP-Series\)](#) section for details about the signal transmission.

3.4. Connecting Steps

ATTENTION! Please make sure that the VINX devices within a system run the same firmware (package version). If the firmwares are different the seamless working is not guaranteed.

3.4.1. Preparing the Network

For the correct installation build a Local Area Network with a Layer 3 (L3) type switch (highly recommended). However, Unicast mode requires only Layer 2 (L2) switch. In both cases the switch must support the Multicast routing.

ATTENTION! VINX Encoder and Decoder send certain system commands over multicast packages. If the multicast routing is disabled on the network, the signal transmission may fail.

Layer 2 vs. Layer 3 Switch

The VINX Encoders and Decoders use multicast routing. The managed switch in the network shall offer the following capabilities:

- IGMPv2
- IGMP snooping
- IGMP fast leave
- IGMP Querier
- Multicast filtering
- 9k MTU - Jumbo/Giant frames

These features are supported by the Layer 3 type switches. Please see more technical information about the network requirements in the [Application Note \(LW-AN-001\)](#) section.

3.4.2. Point-to-Multipoint Transmission (Multicast Mode)

HDMI Connect an HDMI source device (e.g. a computer) to the HDMI input port of the Encoder. Connect HDMI display devices to the HDMI output port of the Decoder devices for the Video Wall application.

VGA Connect the desired VGA source (e.g. a laptop) to the Encoder.

RS-232 Optionally for RS-232 serial transmission: connect the desired devices (e.g. a touch Control, relay box) to the RS-232 ports by the supplied serial cables.

USB Optionally for USB extension: connect USB devices to the USB ports of the Decoders. Connect the desired host device (e.g. computer) to the Encoder via the USB mini-B type port.

Audio Optionally for audio transmission: connect the desired audio source device (e.g. a media player) to the audio input port of the Encoder. Optionally for audio extraction: connect an audio amplifier and speakers to the audio output port of the Decoder.

CATx Connect CATx cables between the VINX devices and the L3 Switch.

Power For devices with local power only: connect the power cord of the supplied adaptor to the DC input first, then to the AC power socket.

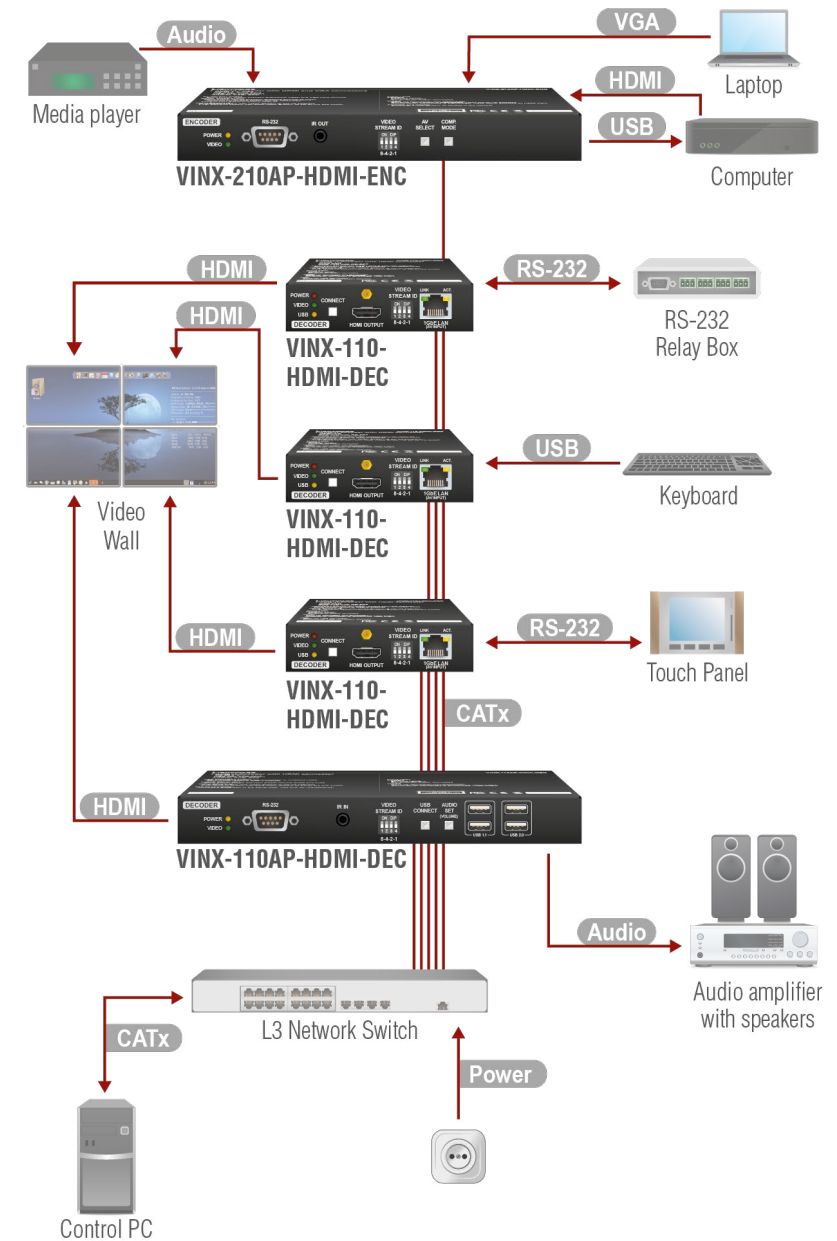

For more information about installation techniques please see the [Installation Checkpoints](#) section.

3.4.3. Point-to-Point Transmission (Unicast Mode)

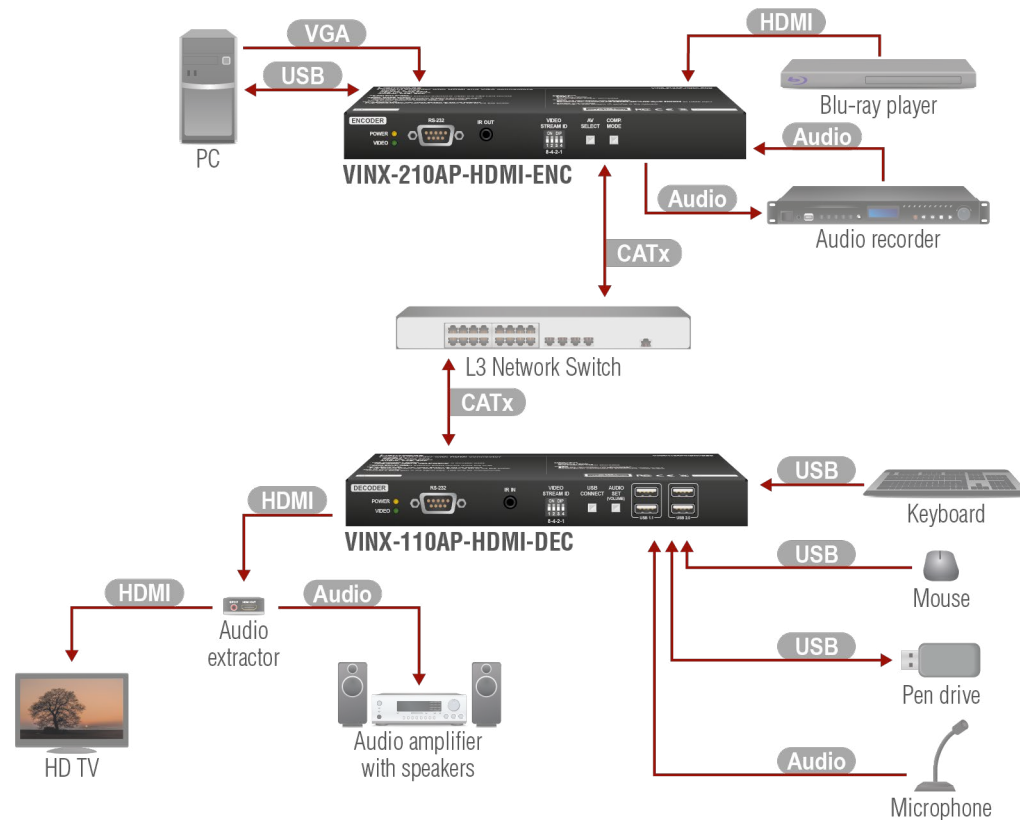

HDMI Connect an HDMI source device (e.g. a blu-ray player) to the HDMI input port of the Encoder.
Connect a HDMI display device to the HDMI output port of the Decoder device.
Optionally for audio extraction: connect an audio extractor device between the display device and the Decoder.

VGA Connect the desired VGA source (e.g. a computer) to the Encoder.

USB Optionally for USB extension: connect USB devices to the USB ports of the Decoder. Connect the desired host device (e.g. computer) to the Encoder via the USB type-B port.

Audio Optionally for audio extraction: connect an audio amplifier and speakers to the audio output port of the audio extractor.
Optionally for return audio transmission: connect the desired audio source device (e.g. a microphone) to the audio input port of the Decoder. Connect an audio recorder to the audio input and output ports of the Encoder, thus, you can both record and embed the audio signal in the HDMI stream.

CATx Connect CATx cables between the VINX devices and the L3 Switch.

Power For devices with local power only: connect the power cord of the supplied adaptor to the DC input first, then to the AC power socket.

3.4.4. Installation Checkpoints

The following help to have a successful install:

- Use **CAT7 SFTP AWG23** cables for connecting the devices; the maximum allowed cable length is 100m.
- Supply the devices by **local adaptors** or by **PoE**; the feature is enabled on the RJ45 ports by default.
- **Power on** the devices as the final step.
- **Connect a computer** to the network to arrange the necessary settings easily (see the [Software Control Options](#) chapter).
- **Group the devices** by the DIP switch or via the built-in website.
- Make sure that each Encoder has a **unique video stream ID**. Set the same ID in the desired Decoders and Encoder.
- Check if the **desired input port** is selected to transmit.
- **Universal EDID** is emulated on the input ports that supports many common resolutions. If necessary, emulate a specific resolution by selecting a factory pre-programmed EDID.
- Select the **desired Decoder for USB** transmission in Multicast mode. (The USB connection is established automatically in Unicast mode.) Pay attention to the USB port types: USB 1.1 and USB 2.0 support.

4

Device Concept

The following chapter describes the features of the device with a few real-life examples.

- ▶ [VINX DEVICE CONCEPT](#)
- ▶ [VIDEO INTERFACE](#)
- ▶ [ANALOG AUDIO INTERFACE](#)
- ▶ [USB INTERFACE](#)
- ▶ [DANTE® AUDIO OUTPUT INTERFACE](#)
- ▶ [RS-232 INTERFACE](#)

4.1. VINX Device Concept

DIFFERENCE: The number of the Encoder and Decoder devices is 'limited' to 100 within a system with firmware package v1.x.

The key feature of the VINX series is the AV signal transmission from an Encoder to many Decoder devices. The video wall can be expanded at a later time, e.g. building a wall with 12 Decoders and add further 12 Decoders later. Another feature is the transmission of RS-232, USB and Infrared signals.









INFO: The USB, Serial, and IR data transmission works independently from the video signal presence.

Unicast Mode (Point-to-Point Connection)

A Decoder is connected to an Encoder device.

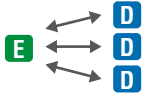
Multicast Mode (Point-to-Multi point Connection)

Many Decoder devices are connected to the same Encoder.

Signal	Unicast mode	Multicast mode
Video		
USB		
RS-232		
IR		
Analog* audio		

 Encoder  Decoder

* The Analog audio interface contains limitations, please see the details in the [Analog Audio Interface](#) section.

The USB transmission is available only at one Encoder-Decoder connection at the same time. The desired device can be activated by the front panel button or via the built-in website.

4.2. Video Interface

The following sections describe the modes of the video transmissions. When the necessary network settings are arranged, the following have to be set:

Video Stream ID Setting

DEFINITION: The **Video Stream ID** is a four-digit number sequence that identifies a certain stream generated by an Encoder and received by a Decoder.

The Video Stream ID creates the connection between an Encoder and a Decoder. Set the Video stream ID to the same value in the desired VINX devices:

- Use the **DIP switch** and set a value other than '0000', or
- Set the **DIP switch** to '0000' and define the ID via the **built-in web page**, see the [Video Status and Settings](#) section, or
- Set the **DIP switch** to '0000' and define the ID by sending the necessary **LW3 command** to the device, see the [Setting up a Video Wall \(Example\)](#) section.

INFO: The DIP switch state can be ignored by an LW3 command, see the [DIP Switch Enable](#) section.

Unicast/Multicast Mode Setting

DEFINITION: The **Unicast** mode is for **point-point** connection: assign an Encoder and a Decoder directly to each other. The devices can be connected directly or via the L3 switch.

DEFINITION: The **Multicast** mode is for **point-multipoint** connection: assign an Encoder and many Decoders to each other (L3 switch is a must in this mode).

Set the desired working mode of the extenders by:

- Selecting the mode via the **built-in web page**, see the [Advanced Settings](#) section, or
- Sending the necessary **LW3 command** to the device, see the [Setting the Working Mode \(Unicast/Multicast\)](#) section.

Delay in the Video Transmission

Due to the design of the devices frame delay is in the signal transmission from the Encoder towards the Decoder For further details see the [Delay in the Video Transmission](#) section.

4.2.1. One-to-one Video Transmission (Unicast Mode)

The Encoder and the Decoder devices are arranged in a LAN by connecting them to an **L2 or L3 switch**. Setting the extenders to Unicast mode it is possible to extend the video signal by an Encoder to a dedicated Decoder.

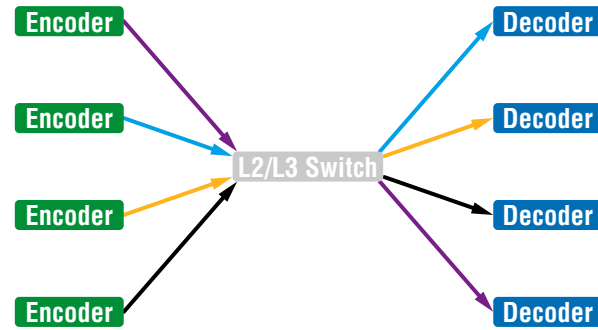

Displayed Images of the Sinks Connected to the Decoders:



INFO: The Encoder and the Decoder can be connected directly and set to Unicast mode. In this case there is no need an L2/L3 switch but there is no way to communicate with other VINX devices.

4.2.2. One-to-All Video Transmission (Multicast Mode)

The Encoder and Decoder devices are arranged in a LAN by connecting them to an **L3 switch**. Setting the extenders to Multicast mode a certain video can be extended from an Encoder to multiple Decoders.

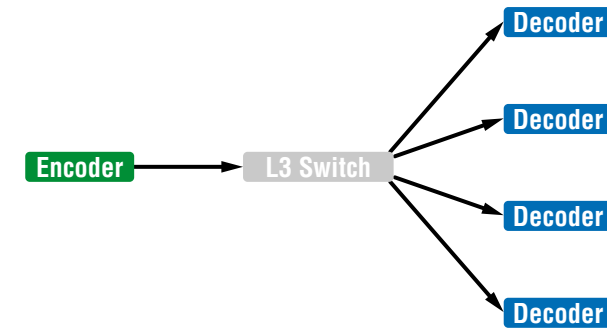

Video Wall Montage



Tiled Video Wall

4.2.3. Layout Examples

Multicast Mode with Video Wall

The Layout

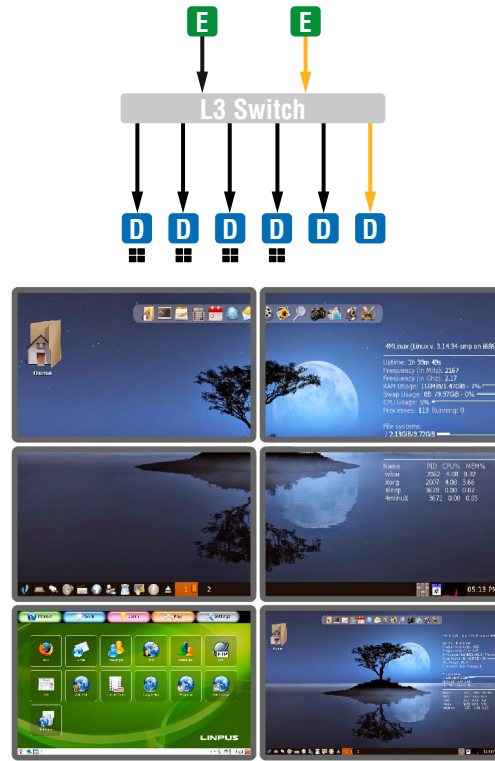

Features

- 2x2-sized video wall is defined and further two single displays are installed (bottom row).
- Any of the video signals can be displayed on the wall and on a single display device.
- The other video signal can be seen on the other display device.
- The video signal on the wall can be changed by using software tools (built-in web or LW3 protocol commands).

Legend

- E** Encoder
- D** Decoder
- The Decoder is assigned to a Video wall

Two Video Walls and Local Monitors with One Encoder

The Layout

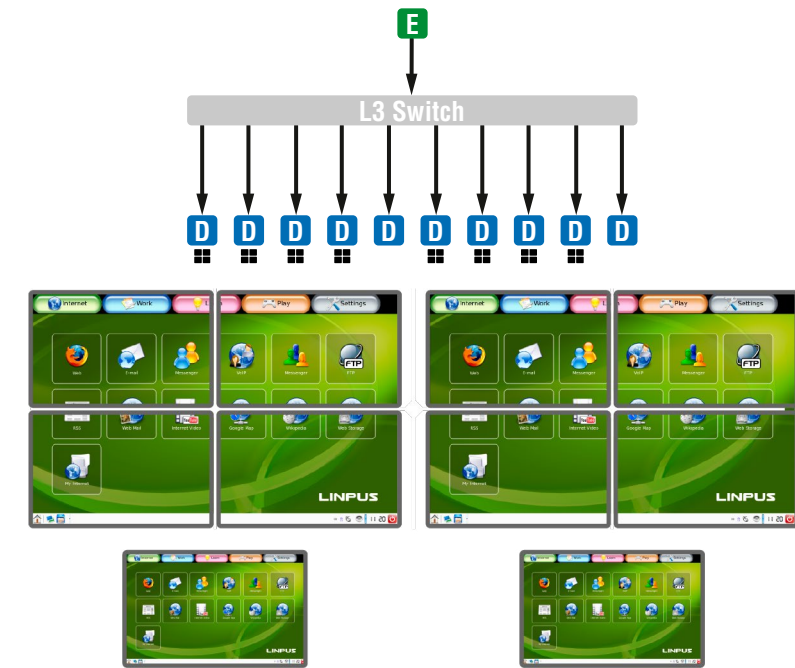

Features

- Two 2x2-sized video walls are defined and further 2 single displays are installed (e.g. the video walls and the local displays are located in different rooms).
- One video signal is displayed on the two video walls and on two local monitors.

Small View and Large View Combined in Multicast Mode

The Layout

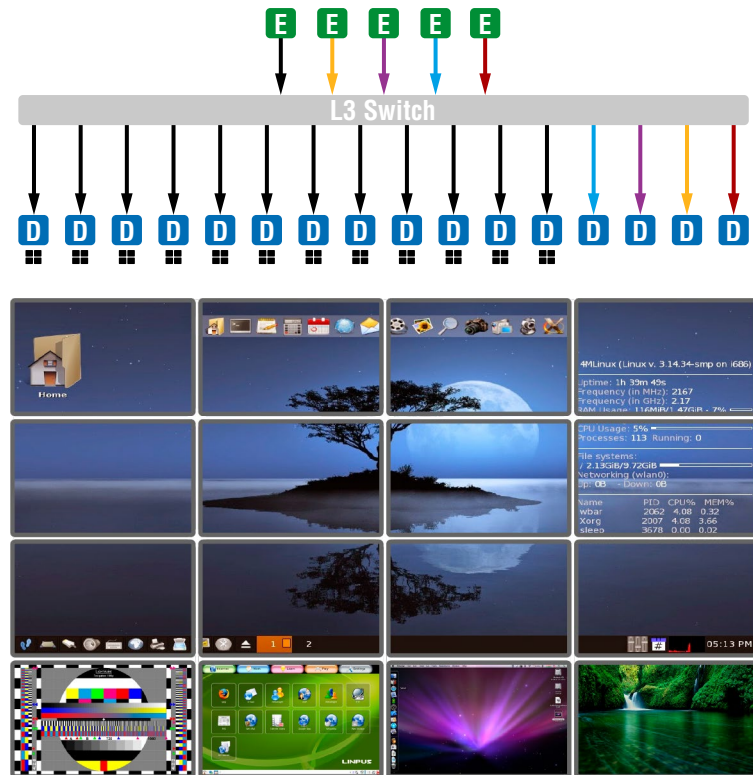

Features

- 3x4-sized video wall is defined and further four single displays are installed (bottom row).
- Any of the video signals can be displayed on the wall and on a single display device.
- The other video signals can be seen on the single display devices (bottom row).
- The video signal on the wall can be changed by using software tools (built-in web or LW3 protocol commands).

4.3. Analog Audio Interface

DIFFERENCE: The analog audio option is available only in VINX AP-series.

Unicast Mode

The Layout



Features

- The audio signal of the Media player is transmitted to the Audio amplifier (forward audio).
- The microphone signal is routed back to the Audio recorder device (return audio).

ATTENTION! The return audio (from the Decoder to the Encoder) is available only if the analog audio input is selected in the Encoder to transmit towards the Decoder. Thus, the other analog audio signal (MIC IN) connected to the Decoder can be routed back to the Audio output of the Encoder.

ATTENTION! The microphone input port applies a fixed bias to feed the connected electret (condenser) microphone. Thus it is not suitable for dynamic microphones which do not contain isolation or an impedance matching transformer. (Danger of damage of the microphone.)

Multicast Mode

The Layout



Features

- The analog audio signal is selected in the Encoder and embedded in the video stream.

4.4. USB Interface

USB 1.1 and USB 2.0 data transmission operates between an Encoder and a certain Decoder device. Connect the host device (e.g. a computer) to the Encoder and the USB devices to the Decoder. Supported USB devices:

- **USB HID devices:** keyboard, mouse, presenter.
- **Mass storage devices:** USB flash drive, external hard drive.

ATTENTION! The USB ports are not recommended for time-sensitive applications (e.g. webcam).

The maximum data transmission rate of USB 2.0 ports is 5 MBit/s.

The transmission works in Unicast and Multicast mode as well, but in latter case, the desired Decoder has to be selected by any of the following ways:

- Pressing the **Mode** button on the front panel for less, than three seconds (the connected display device will show **Starting USB**, the other Sinks will show **Stopping USB** on the screen),
- Pressing the **Acquire USB connection** button in the Advanced tab on the built-in web page (see the [USB Settings \(Multicast Mode\)](#) section), or
- Sending an LW3 command to the desired Decoder.

The USB devices connected to the other Decoders will be still powered but the data transmission is suspended.

ATTENTION! USB 1.1 ports can be used for the stream changing, see the [Keyboard Shortcuts](#) section.

ATTENTION! The active Decoder works like an extended USB hub connected to a computer. Pay attention to the storage device to remove safely before unplugging it or interrupting during a disc operation.

INFO: The USB transmission is automatically enabled between the Encoder and the Decoder in Unicast mode.

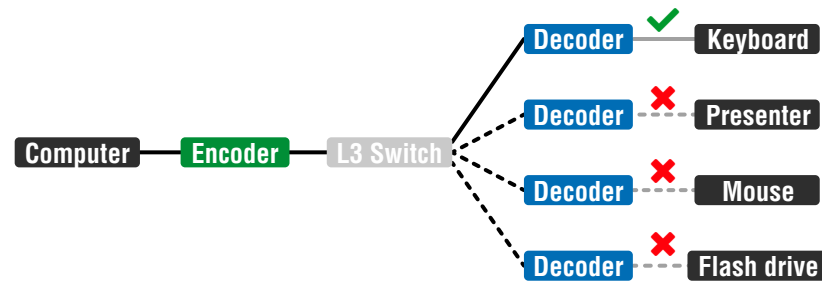

USB Transmission between an Encoder and a Decoder

4.5. Dante® Audio Output Interface

DIFFERENCE: The following section refers to the VINX-120AP-HDMI-ENC-DNT model only.

VINX-120AP-HDMI-ENC-DNT variant contains a special module that allows de-embedding the audio stream of the incoming HDMI signal and transmitting as a 2-channel Dante® or AES67 source over the dedicated RJ45 connector. #dante #audio

ATTENTION! Analog audio input signal cannot be routed to the Dante® audio output.

Port Diagram of VINX-120AP-HDMI-ENC-DNT

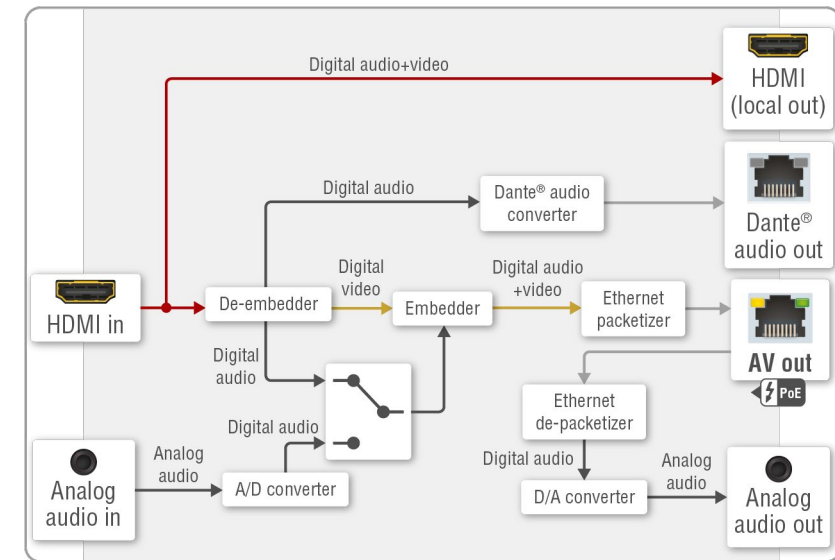

* The analog audio transmission (opposite direction than the video stream) is available only in Unicast mode.

Supported Audio

Input audio type	Signal support
2-ch LPCM **	supported
Multichannel	not supported
Compressed DTS/Dolby	not supported

** The supported sample rates are 44.1, 48, and 96 kHz.

Dante® is a registered trademark of Audinate Pty Ltd.

Important Notes

- It is essential to have the **right QoS settings** in the network switch where the Dante® audio is connected to. See the details in the [Application Note \(LW-AN-001\)](#) section.
- However, the Audio network and the video network are **separated** on distinct LANs (with 2x RJ45 conenctors), the Dante® audio can be transmitted over the same network as used for the VINX video streaming.
- The **AES67 mode** is supported by the VINX extender, which can be set in the Dante® Controller software.
- Multichannel or encoded audio** format cannot be de-embedded. In this case, no audio is sent to the Dante® network.
- Limitation:** VINX video stream and Dante® audio stream is **not in sync**; Dante® audio is 1.1 frame early. The delay occurs during the video transmission from the Encoder towards the Decoder; see more details in [Delay in the Video Transmission](#) section.
- Dante® audio cannot be received by the VINX device.

Settings and Signal Routing

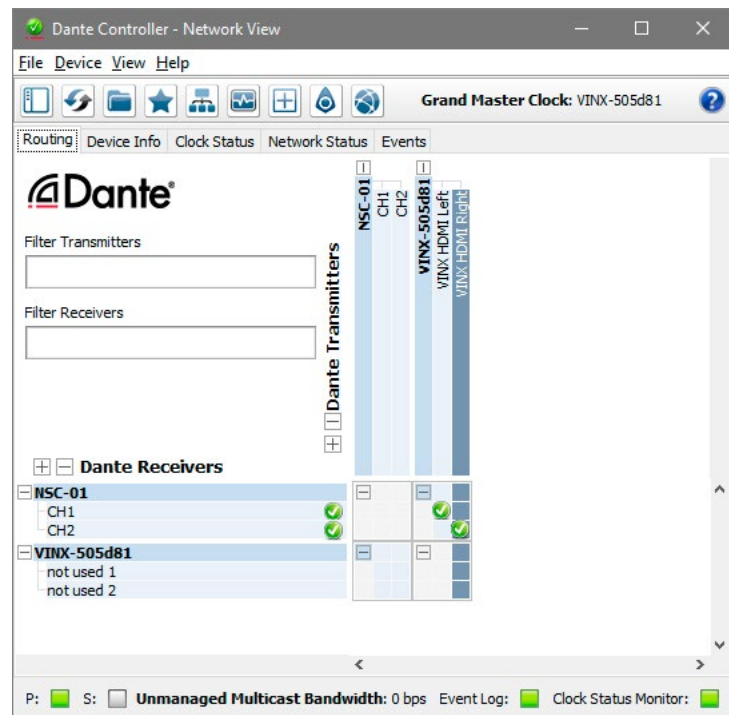

All these features are available in the Dante Controller software which can be downloaded from manufacturer's web page:

<https://www.audinate.com/products/software>

Device Settings

The discovered Dante®-compatible devices are displayed with middle-blue color. Double-click on the name to open the device settings.

The default device name is:

VINX-<Dante_MAC_address_last 6_characters>

It can be changed under Device config tab. Similarly, the channel names can be also renamed. NSC-01 is another device with Dante® audio interface.

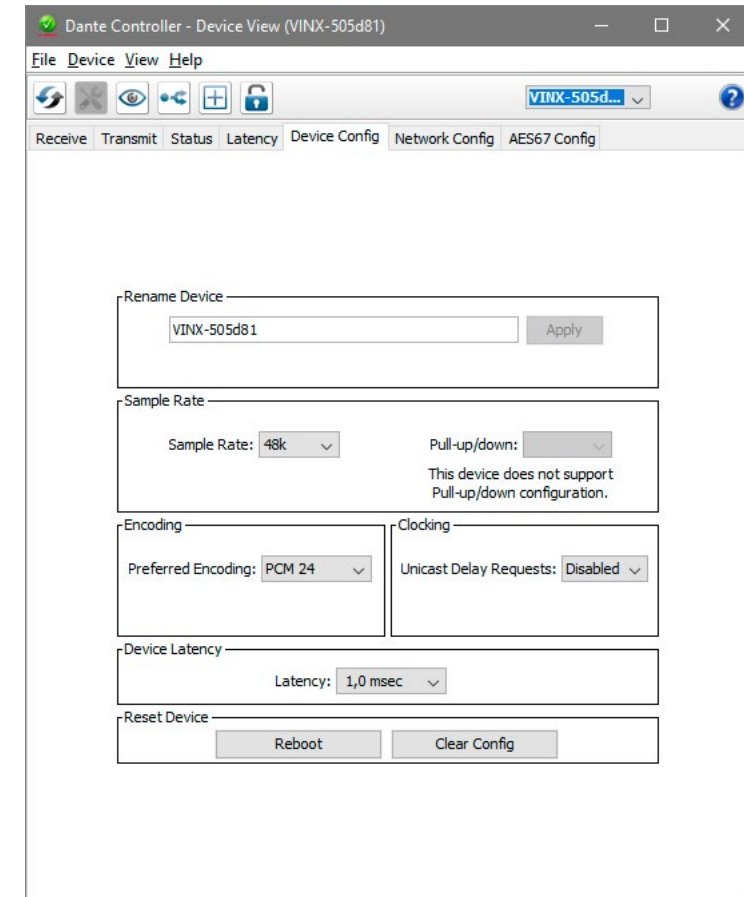

Press the  button to identify the device: the LEDs of the RJ45 connector will blink for six times in red.

4.6. RS-232 Interface

Serial data transmission works between an Encoder and all the connected Decoders which have the same Video Stream ID. This transmission is independent of the current working mode (Unicast/Multicast). To connect serial devices please use the cables supplied with the extenders.

ATTENTION! The serial data is transmitted only if video is transmitted between the affected devices.

Pass-through Mode

DEFINITION: The **Pass-through mode** means fully transparent bidirectional data transmission from an RS-232 port of a VINX Extender to an RS-232 port of a VINX Decoder – and Vice versa.

All data received from the serial ports of the Decoders is transmitted to the serial port of the Encoder and vice versa: the data received from the serial port of the Encoder is transmitted to the serial ports of all connected Decoders.

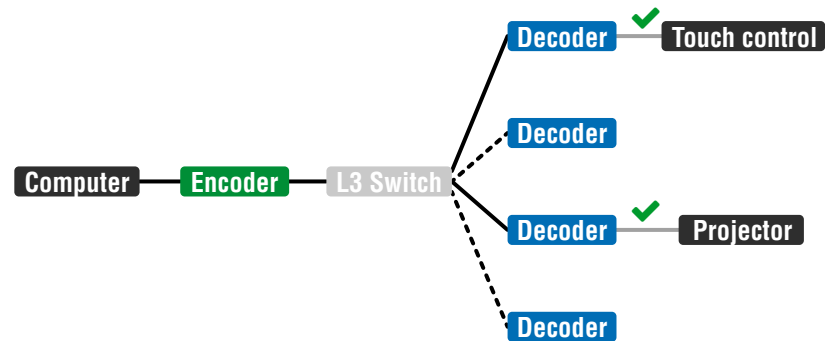

RS-232 Data Transmission (Pass-through mode)

Please note that transmitting data between two Decoders is not possible; see the above figure: sending serial data from the Touch Control to the Projector is not possible.

ATTENTION! The data transmission works only if the serial port parameters are set to the same values in all devices: serial data sender/receiver and the VINX Encoder and Decoder devices.

Command Injection Mode

DEFINITION: The **Command Injection mode** is like an RS-232–TCP/IP bidirectional converter. The mode allows data transmission between a TCP/IP device and a serial device.

When a device is connected to the network (e.g. TCP/IP connection from a computer) and a serial device is connected to the RS-232 port of a VINX device they can communicate with each other.

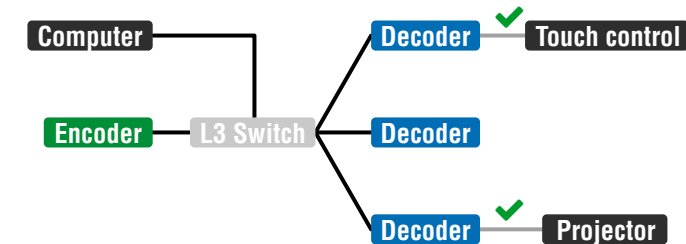

RS-232 Data Transmission (Command Injection mode)

The mode can be enabled as described in the [Setting the RS-232 Port Mode](#) section.

5

Software Control Options

The VINX extenders allow setting all the parameters via a user-friendly interface. Open a web browser (Google Chrome or Mozilla Firefox is highly recommended) and connect to the extender to access the parameters and settings. The other option is to use the Lightware Device Controller (LDC) software and connect to the device without a web browser. The features are described in the coming sections.

- ▶ [CONNECTION METHODS](#)
- ▶ [CONNECTING VIA THE BUILT-IN WEB PAGE](#)
- ▶ [CONNECTING USING LIGHTWARE DEVICE CONTROLLER](#)
- ▶ [MAIN SETTINGS \(ENCODER\)](#)
- ▶ [MAIN SETTINGS \(DECODER\)](#)
- ▶ [CROSSPOINT MENU](#)
- ▶ [EDID MENU](#)
- ▶ [ADVANCED SETTINGS](#)
- ▶ [VIDEO WALL SETUP](#)

5.1. Connection Methods

When the VINX device and a control device (PC, laptop, mobile device) are connected to the same network, the VINX can be configured via a web browser (Google Chrome and Mozilla Firefox are recommended) or by running Lightware Device Controller (LDC).

Step 1 – Make the VINX and the control devices meet

The following cases may occur in case of a factory default device:

- a) **There is a DHCP server** in the network: the VINX device got an IP address from the DHCP server. Make sure the control PC is connected to the same network.
- b) **There is no DHCP server** in the network: the VINX device generates an IP address in the 169.254.x.x range (AutoIP). Set the IP address of the control PC to match with this range (with subnet mask 255.255.0.0).

Step 2 – Establish the connection

Connect to the VINX by any of the following ways:

- Connecting by the Lightware Device Controller Software, or
- Connecting via the Built-in Web Page.

5.2. Connecting via the Built-in Web Page

ATTENTION! The supported web browsers are Google Chrome and Mozilla Firefox.

If You do not Know the IP Address

TIPS AND TRICKS: When a monitor/projector is connected to a Decoder, the IP address will be displayed in the splash screen.

Find the MAC address of the desired device (located on the top of the extender) and launch the web browser:

- a) In case of a **Decoder**, type the following in the address line:
<http://LWR-clientAABBCCDDEEFF.local>
- b) In case of an **Encoder**, Type the following in the address line:
<http://LWR-gatewayAABBCCDDEEFF.local>

AABBCCDDEEFF is the MAC address of the device (without hypens) – which can be seen on the housing of the extender.

INFO: When you successfully connected to an Encoder, all the other counterpart devices will be listed in the **Main settings** tab (General section).

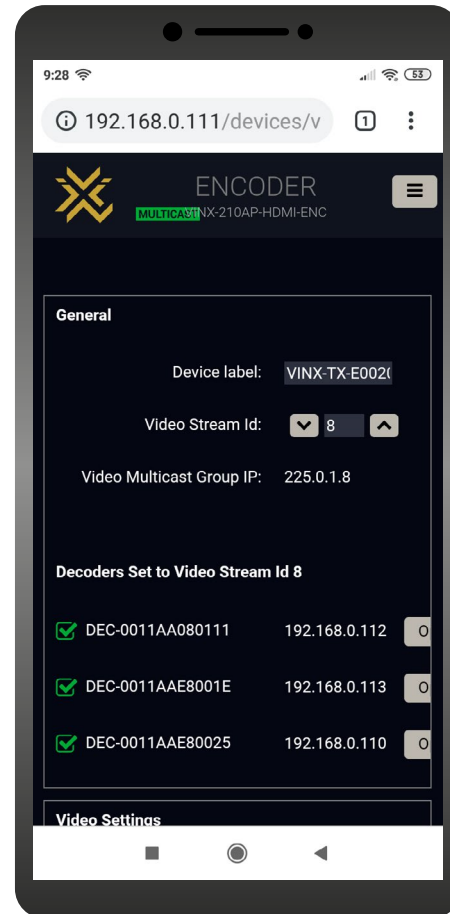

The Main Window – Displayed on a Mobile Device

5.3. Connecting Using Lightware Device Controller

Download the software from www.lightware.com and install it. After the installation, the Windows and the macOS application has the same look and functionality. This type of the installer is equal with the Normal install in case of Windows and results an updateable version with the same attributes.

Installation for Windows OS

Step 1. Run the installer. If the User Account Control drops a pop-up message click Yes.

Step 2. During the installation you will be prompted to select the type of the installation: **normal** and the **snapshot** install:

Normal install	Snapshot install
Available for Windows and macOS	Available for Windows
The installer can update only this instance	Cannot be updated
Only one updateable instance can exist for all users	Different versions can be installed for all users

Comparison of the Installation Types

ATTENTION! Using the Normal install as the default value is highly recommended.

Installation for macOS

Mount the DMG file with double clicking on it and drag the LDC icon over the Applications icon to copy the program into the Applications folder. If you want to copy the LDC into another location just drag the icon over the desired folder.

5.3.1. Upgrading the LDC

When the **Device Discovery** window appears automatically, the program checks the available updates on Lightware’s website and opens the update window if the LDC found updates (default setting).

Set the desired update setting in the **Options** section. When the **Check for updates automatically** option is marked, the LDC tries to find a new version after startup.

INFO: The Update window can be opened manually by clicking the question mark and the Update button.

5.3.2. Running the LDC

Launch the LDC software. The **Ethernet** tab consists of two lists:

- **Favorite Devices:** You can add any Lightware device that is connected via Ethernet and no need to browse all the available devices. Devices can be added by pressing the **Add** button or marking the desired device by the ★ symbol in the **All Devices** list.
- **All Devices:** The Lightware devices are listed which are available in the connected network.

Select a device and click on the green **Connect** button, or just double-click on it.

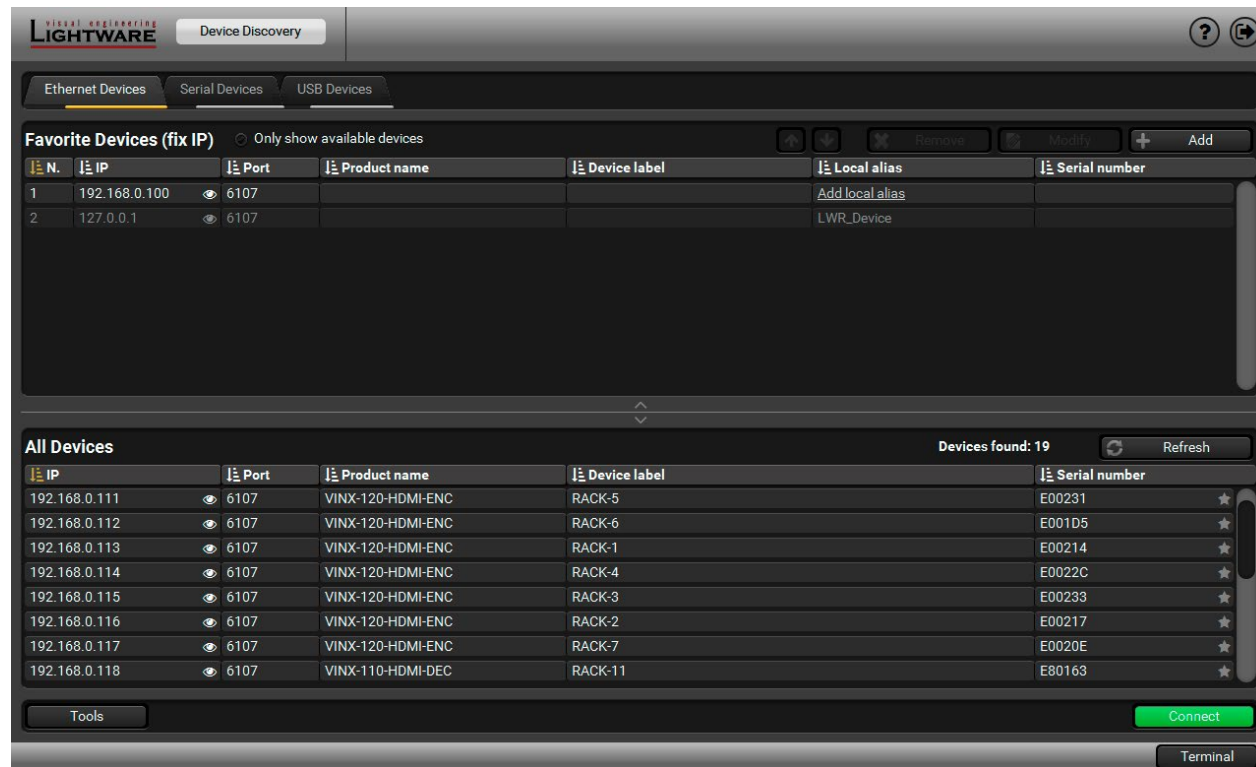

Device Discovery Window

Command Line Parameters

The common way to start the software is double-click on the LDC icon but you can use command line parameters for special functions as follows.

Direct Connection to a Known IP Address

The LDC can be connected to a device with a defined IP address directly; in this case, the Device Discovery window is not displayed. Apply the command line parameters as follows (for VINX devices – and for LW3 devices in general – use the port number 6107):

Format: `LightwareDeviceController -i <IP_address>:<port>`

Example: `LightwareDeviceController -i 192.168.0.20:6107`

Adjusting the Zoom

The window can be zoomed to a specific value to fit to the resolution of the desktop (higher/lower). '1' is the default value (100%).

Format: `LightwareDeviceController -z <magnifying_value>`

Example: `LightwareDeviceController -z 1.2`

ATTENTION! The last set value is stored and applied when LDC is started without a parameter

Further Tools

The **Tools** menu contains the following options:

- **Log Viewer:** The tool can be used for reviewing log files which have been saved previously.
- **Create EDID:** This tool opens the Easy EDID Creator wizard which can be used for creating unique EDIDs in a few simple steps. Functionality is the same as the Easy EDID Creator.
- **Demo Mode:** This is a virtual MX-FR17 matrix router with full functionality built into the LDC. Functions and options are the same as a real MX-FR17 device.

The **Terminal** window is also available by pressing its button on the bottom.

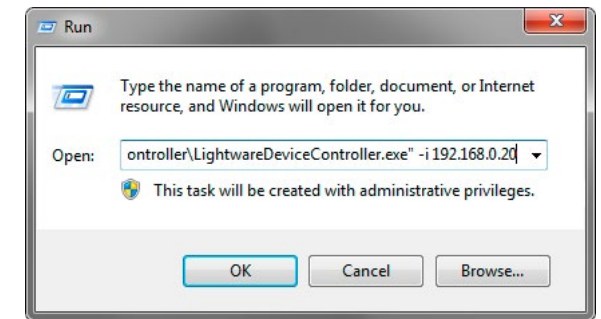

5.4. Main Settings (Encoder)

5.4.1. General Settings

Unicast Mode *#unicast*

The Video stream ID is used not only in Multicast mode. To assign an Encoder and a Decoder in Unicast mode, set the same Video stream ID in both devices.

Grouping the VINX Extenders *#multicast*

Video Stream ID *#videostreamid #streamid*

The current ID number is shown. The following rules are defined to avoid Video Stream ID conflicts:

- When the DIP switch is in **0000** position the SW setting will be valid or else the HW setting (DIP switch) will be valid.
- When the DIP switch is set back to **0000** the SW setting will inherit the ID (the previous DIP switch value).
- SW setting and HW setting can be combined within the group but in this case the DIP switch value will determine the common Video Stream ID.

INFO: The DIP switch state can be ignored by an LW3 command, see the [DIP Switch Enable](#) section.

Decoder Assignment

The list contains the VINX devices which are available within the same subnet. Mark the desired devices to set the same ID.

Device Label *#label #devicelabel*

Unique name (up to 32 ASCII characters) can be set which will be visible when the given device is listed in the built-in web page of other VINX devices. Furthermore, the name is listed when browsing the client list of a DHCP server.

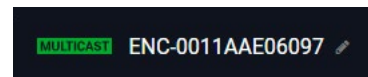

ATTENTION! It might happen that two or more Encoders installed in the same system with the same Video Stream ID. That would result display problems (e.g. more mouse cursors are displayed when desktop images are shown). Check the Video Stream ID settings of the Encoders.

ATTENTION! The **Video wall setup** submenu is not displayed on mobile devices in most cases due to the limitation of these screens.

TIPS AND TRICKS: Press the VINX drawing in the top left corner to navigate back to the Device Discovery window.

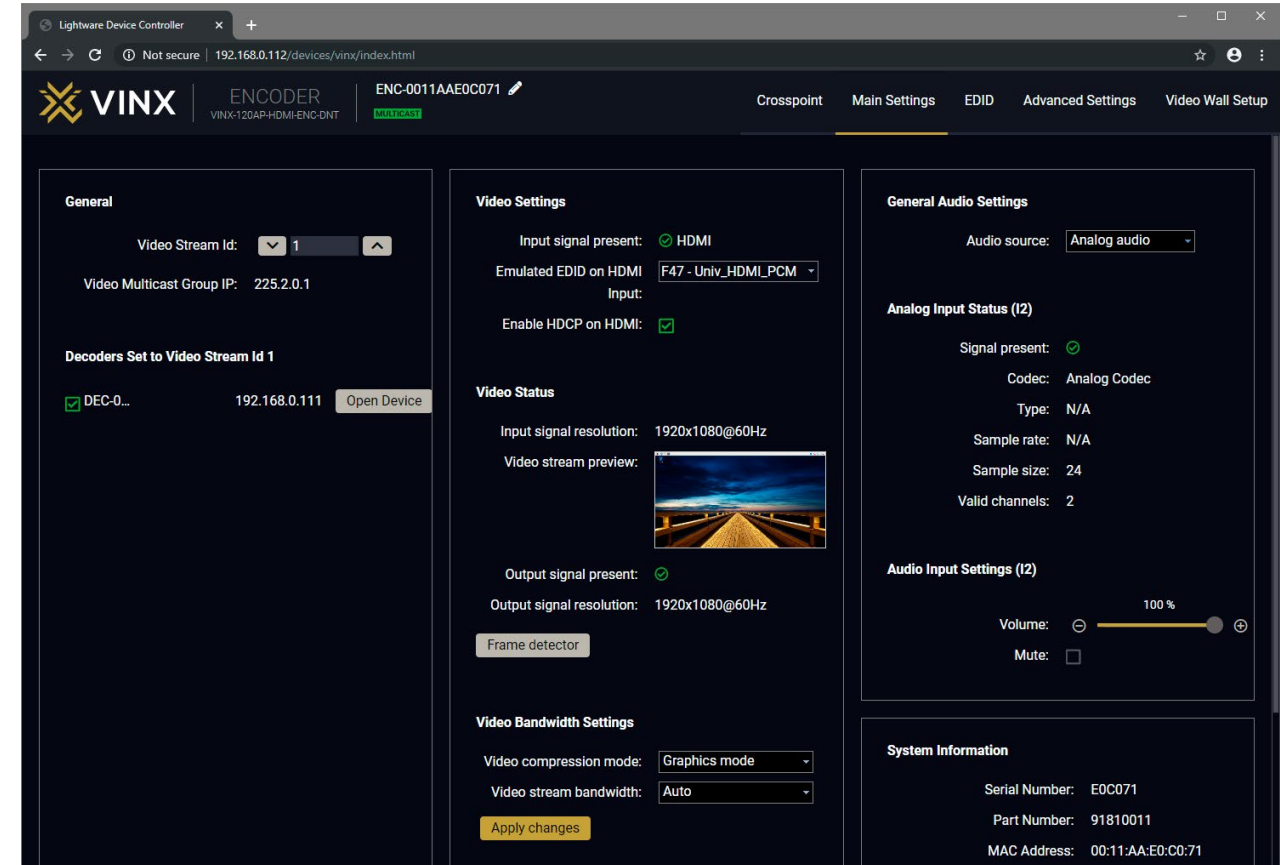

The Main Window of the Built-in Web Page (Encoder) – Displayed on a Computer

Symbol Legend

- UNICAST** The current working mode
- MULTICAST** The Video stream ID is set by the DIP switch
- DIP SWITCH** The given Decoder belongs to a video wall
- Displaying the Main Menu (if there is not enough space)
- Connecting to another device (opened in new tab)

5.4.2. Video Status and Settings

The properties of the incoming and outgoing video signals are displayed in the following sections.

Video Settings *#hdc*

- The emulated EDID can be selected (see the [EDID Operations](#) section).
- Setting the HDCP status on the input:
 - **Enable:** the connected source will detect the Encoder is **HDCP-compliant**.
 - **Disable:** the connected source will detect the Encoder is **not** HDCP-compliant. Thus, if the content allows the signal will not be HDCP encrypted.

Video Status *#status*

- Input signal presence and **Video stream preview**. The image is updated approx. every third seconds.
- Displaying the **Frame Detector** in a new window, see the [Frame Detector](#) section.

ATTENTION! If the HDCP setting is changed a window will pop up to confirm as the device will be restarted to apply the settings.

ATTENTION! The EDID information cannot be read by the source attached to the HDMI input of an Encoder if HDCP is disabled on the input. That may stop the video transmission in case of certain source devices.

Video Source Selection *#source*

DIFFERENCE: The feature is available in VINX-210AP-HDMI-ENC device only.

- The desired video source can be selected by the drop-down menu: **HDMI / VGA / Auto**.
- **Auto mode:** the first connected source shall remain active as long as signal is present on the respective input. If sync is lost for at least 3 seconds, a switch over to the other source shall occur. No automatic switch back to the original input shall occur when the signal is restored.

Video Bandwidth Settings

Compression Mode *#compression*

When the network bandwidth is not enough to transmit the video signal the following modes are available in the Encoder:

- **Movie mode** (Lower image quality @ Less bandwidth): The image quality is adjusted to the available bandwidth. If the bandwidth is decreased the image quality will be lower, but the video streaming will be continuous.
- **Graphics mode** (Best image quality @ High bandwidth): The image quality is kept at a high level. If the bandwidth is decreased the image quality does not change, but frame dropping may appear.

The setting has an affect when the available bandwidth is less than required.

Video Stream Bandwidth *#bandwidth*

A specific bandwidth limitation can be set in the Encoder which **affects only the video signal** transmission. The following values are available:

Auto / 10 Mbps / 50 Mbps / 100 Mbps / 150 Mbps / 200 Mbps

The **Auto** setting is the default value which means: the available bandwidth is determined according to current network traffic.

ATTENTION! If the Bandwidth setting is changed a window will pop up to confirm as the device will be restarted to apply the settings.

5.4.3. Audio Settings

The General audio settings allows selecting the desired audio source and setting the volume of the output signal.

Auto select analog mode: the Analog audio input port is selected when a plug is connected.

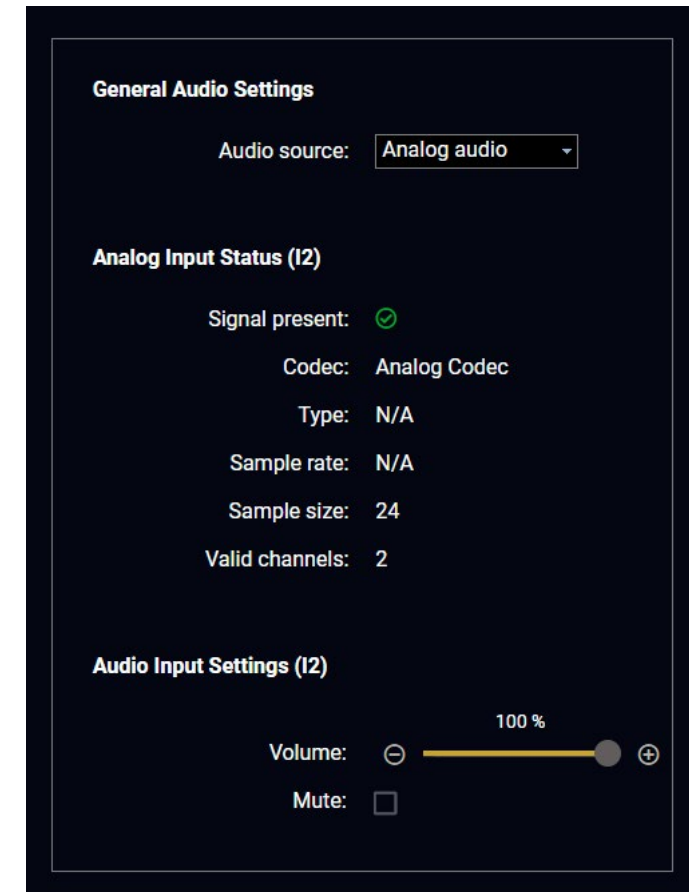

#audio #analogaudio #volume #mute #unmute

5.5. Main Settings (Decoder)

5.5.1. General Settings

Unicast Mode *#unicast*

The Video stream ID is used not only in Multicast mode. To assign an Encoder and a Decoder in Unicast mode, set the same Video stream ID in both devices.

Grouping the VINX Extenders *#multicast*

Video Stream ID *#videostreamid #streamid*

The current ID number is shown. The following rules are defined to avoid Video Stream ID conflicts:

- When the DIP switch is in **0000** position the SW setting will be valid or else the HW setting (DIP switch) will be valid.
- When the DIP switch is set back to **0000** the SW setting will inherit the ID (the previous DIP switch value).
- SW setting and HW setting can be combined within the group but in this case the DIP switch value will determine the common Video Stream ID.

INFO: The DIP switch state can be ignored by an LW3 command, see the [DIP Switch Enable](#) section.

Encoder-Decoder Assignment

The list contains the VINX encoders available within the same subnet. Mark the desired devices to set the same ID.

Device Label *#label #devicelabel*

Unique name (up to 32 ASCII characters) can be set which will be visible when the given device is listed in the built-in web page of other VINX devices. Furthermore, the name is listed when browsing the client list of a DHCP server.

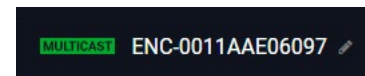

ATTENTION! It might happen that two or more Encoders installed in the same system with the same Video Stream ID. That would result display problems (e.g. more mouse cursors are displayed when desktop images are shown). Check the Video Stream ID settings of the Encoders.

ATTENTION! The **Video wall setup** submenu is not displayed on mobile devices in most cases due to the limitation of these screens.

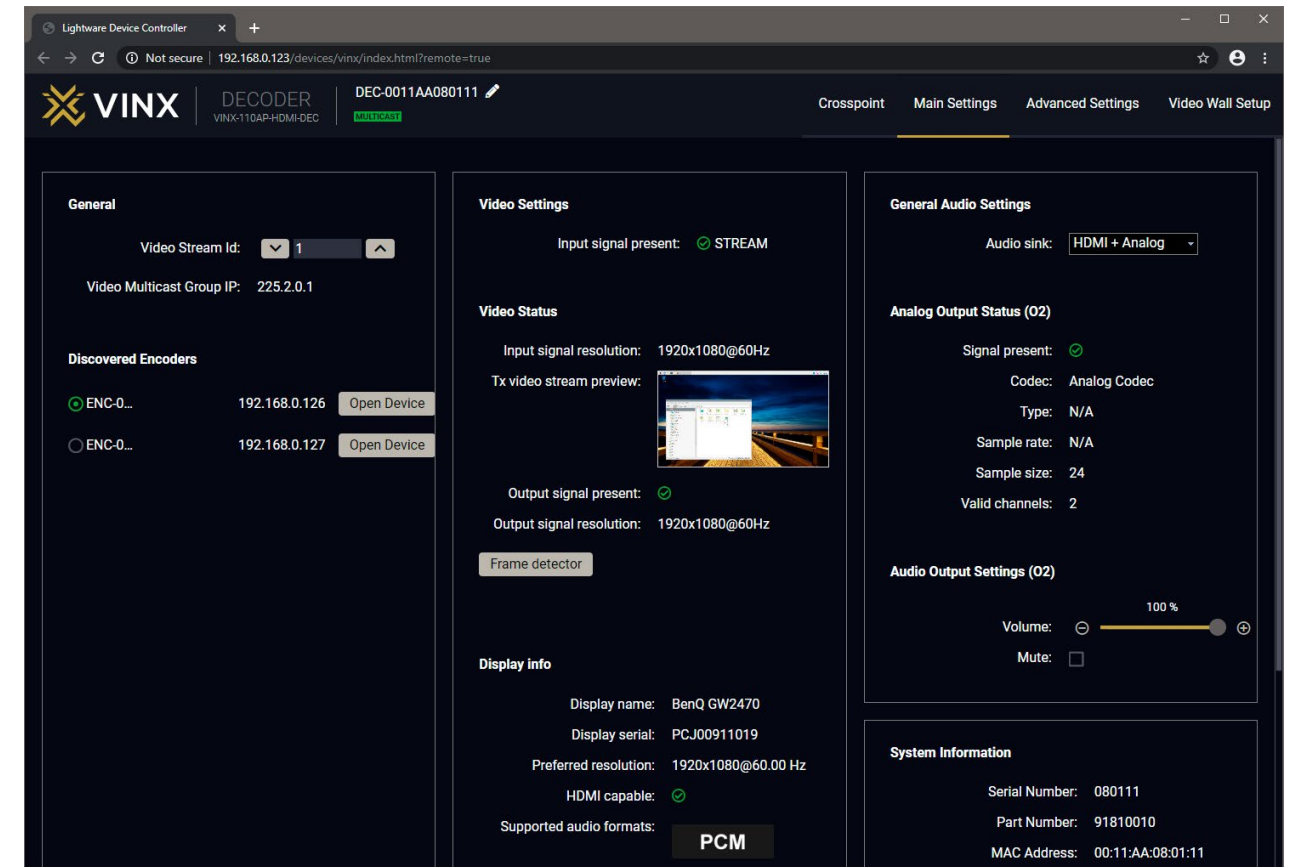

The Main Window of the Built-in Web Page (Decoder) – Displayed on a Computer

5.5.2. Video Status and Settings

The content of the window is almost the same as in the case of the Encoder. The Video Status Information is filled with details when valid signal is detected and a sink is connected. The addition is the **Scaler settings** which is also available on the **Advanced Settings** page.

DEFINITION: Scaling a video signal means changing the image resolution. The new resolution may change the aspect ratio and/or the appearance of the image. *#status*

Scaler settings *#scaler*

The outgoing video signal can be set in each Decoders separately.

Output Scaling

- **Pass-through:** the resolution, the refresh rate, and the type of the outgoing and incoming signals are the same.
- **Auto detect from EDID:** the resolution of the outgoing video is scaled to meet with the preferred timing coming from the EDID of the connected display device.
- **Custom:** a wide range of the scaling resolutions are available from 640x480 till 4096x2160.

Output Standard

When the Output scaling is set to **Custom**, the outgoing signal can be set to **DVI** or **HDMI**.

Picture Rotation/Flip *#rotation #flip*

The following options are available:

- No rotation,
- Flip vertically,
- Flip horizontally,
- Rotate by 90 / 180 / 270 degrees.

5.5.3. Audio Settings

Audio sink: you can select where to transmit the audio, towards the HDMI sink and/or the analog audio device connected to the Decoder.

The volume of the analog audio can be set by the slider.

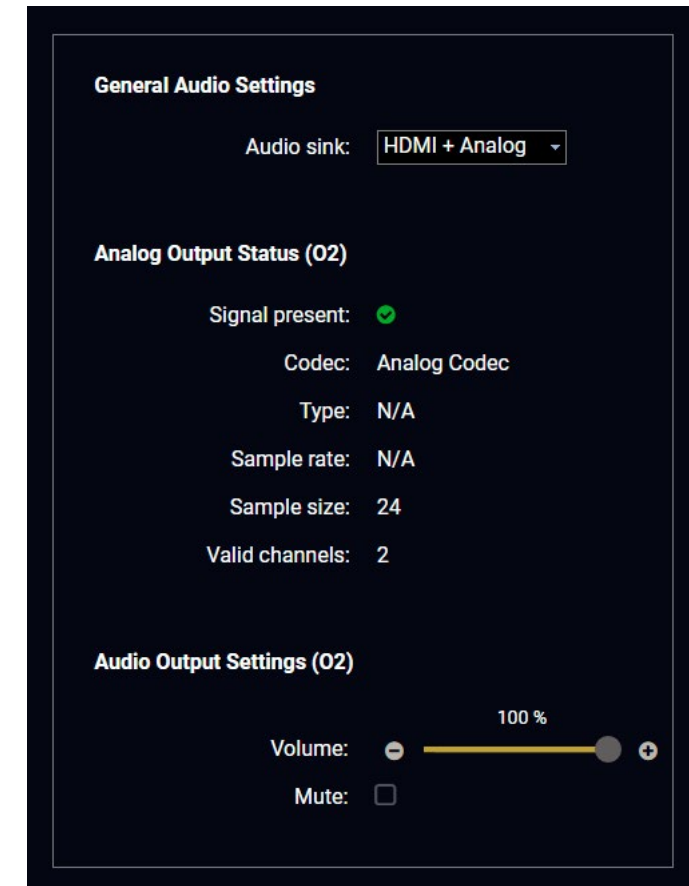

General Audio Settings in a Decoder

#audio #analogaudio #volume #mute #unmute

5.6. Crosspoint Menu

The page allows the user make crosspoint switches between the encoders and the decoder end-points (individual decoders or video walls) in the system. Only at most the **first 16 Encoders** shall appear in the Crosspoint page. If the subnet contains more encoders, the Crosspoint page shall display an appropriate message indicating why the Crosspoint pane and the Property panel is not displayed. The Crosspoint page can show **up to 24 devices** (Encoder+Decoder) at most. *#crosspoint #switch*

The **TX** means the **Encoder**, the **RX** means the **Decoders**, and the defined **Video Walls** are shown as **VW**.

ATTENTION! Please note that the Decoders which belong to a Video wall will not be displayed as individual devices.

The applied icons in the Crosspoint mean different states as follows:

- Unselected connection
- Selected but disabled connection
- Selected connection with no signal present
- Selected connection with signal present
- Unselected and disabled connection
- Active stream, but no signal present
- Stream ID is set by DIP switch
- Signal present

Press the **i** button to open the **Legend** window and display above list.

5.6.1. Frame Detector

The ports can show detailed information about the signal like blanking intervals and active video resolution. This feature is a good troubleshooter if compatibility problems occur during system installation. Lightware’s Frame Detector function works like a signal analyzer and makes possible to determine the exact video format that is present on the port, thus helps to identify many problems. E.g. actual timing parameters may differ from the expected and this may cause some displays to drop the picture. *#framedetector*

Frame Detector measures detailed timings on the video signals just like a built-in oscilloscope, but it is much more easy to use. Actual display area shows the active video size (light grey). Dark grey area of the full frame is the blanking interval which can contain the info frames and embedded audio data for HDMI signals. Shown values are measured actually on the signal and not retrieved only from the HDMI info frames.

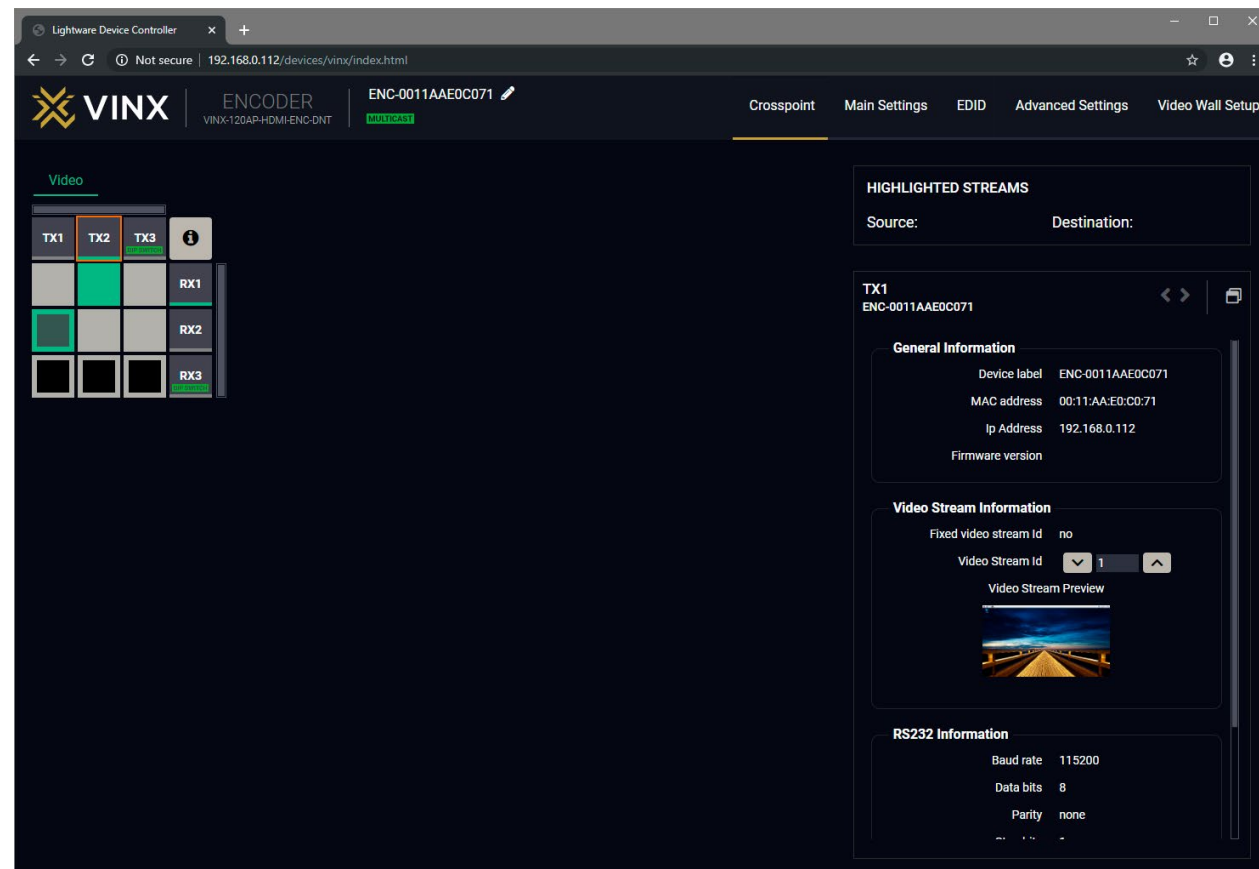

The Crosspoint Menu

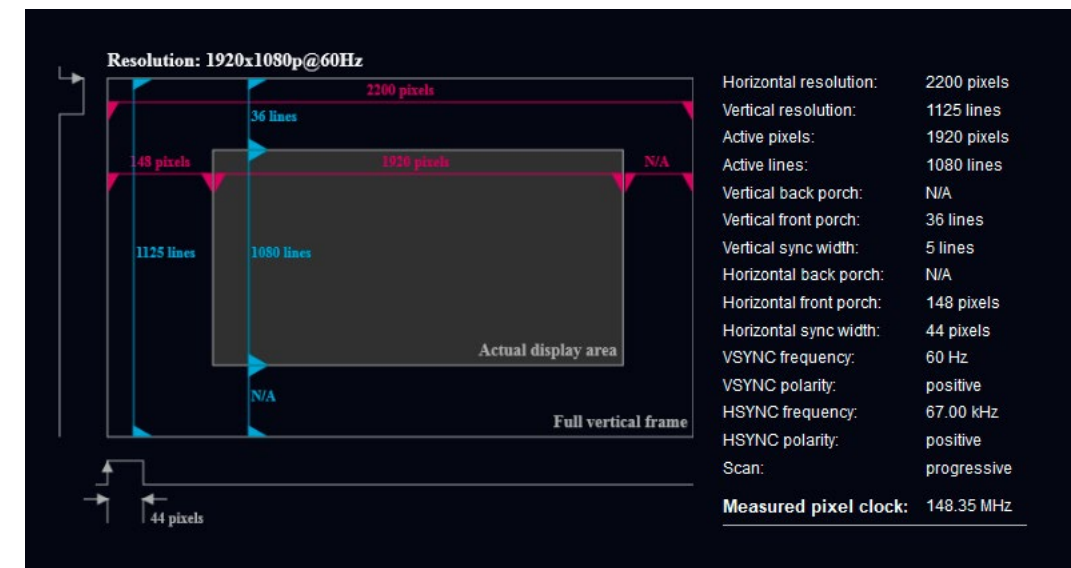

Frame Detector (Opened in a New Tab)

5.7. EDID Menu

DEFINITION: The **Extended Display Identification Data (EDID)** is the passport of the display devices. It contains information about the capabilities of the display, such as supported resolutions and audio formats, refresh rates, the type and the manufacturer of the display device, etc.

Advanced EDID Management is available in the Encoder. Navigate to the **EDID** menu. There are two panels: the left contains the **Source EDIDs**, the right panel contains the **Destination places** where the EDIDs can be emulated or copied. See more information in the [EDID Management](#) section. `#edid`

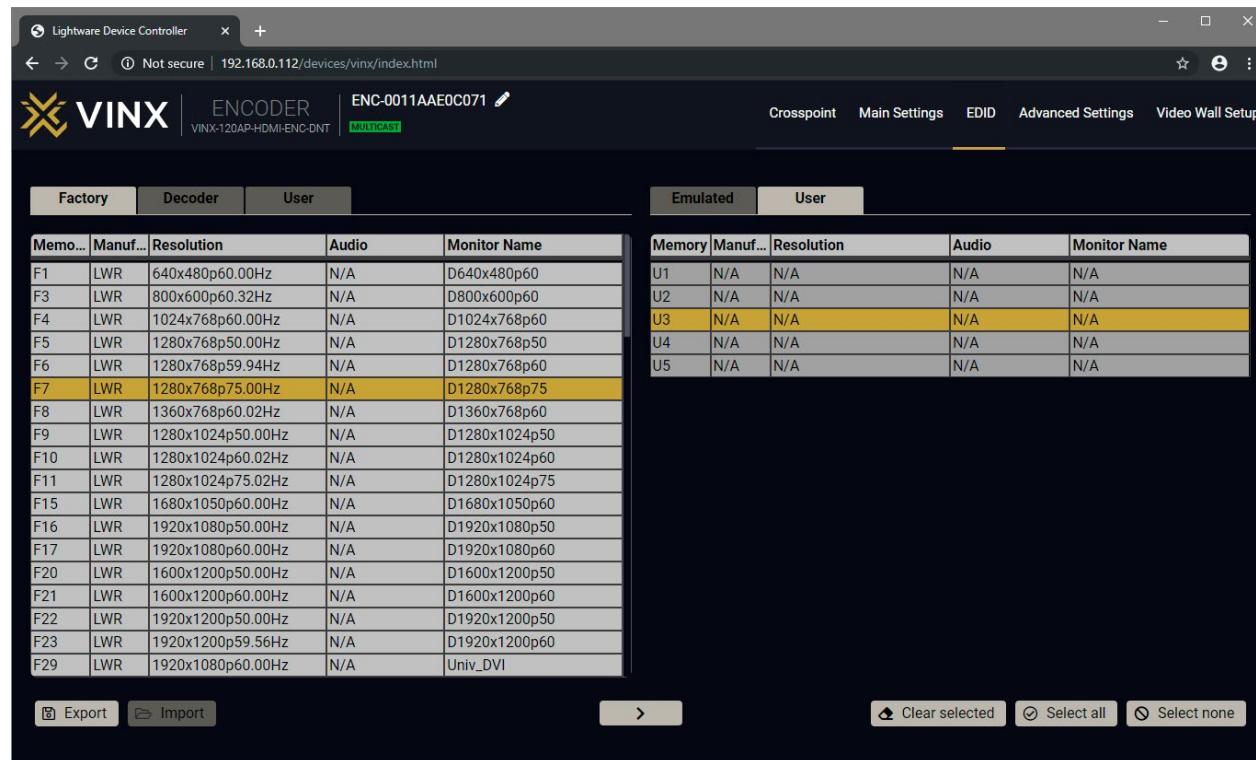

The EDID Menu (in an Encoder)

5.7.1. The EDID Memory Structure

The EDID memory consists of four parts:

- **Factory EDID list** shows the pre-programmed EDIDs (F1-F132).
- **Decoder EDID list** shows the EDIDs of the display devices connected to the assigned Decoders. The Decoders store the last display devices' EDID on the HDMI output, so there is an EDID shown even if there is no display device attached to the output port at that moment.
- **User memory locations** (U1 – U5) can be used to save custom EDIDs. Any EDID from any of the User/Factory/Decoder EDID lists can be copied to the user memory.
- **Emulated EDID** shows the currently emulated EDID for the HDMI input port of the Encoder. The source column displays the memory location that the current EDID was routed from.

5.7.2. EDID Operations

Changing the Emulated EDID

- Step 1.** Choose the desired **EDID list** on the source panel and select an **EDID**.
- Step 2.** Select the **Emulated** tab on the Destination panel.
- Step 3.** Select the desired **port** on the right panel.
- Step 4.** Press the **Transfer** button to change the emulated EDID.

Learning an EDID

The process is the same as changing the emulated EDID; the only difference is the Destination panel: select the **User** tab. Thus, one or more EDIDs can be copied into the user memory.

Exporting an EDID

The source EDID can be downloaded as a file (*.EDID) to the computer.

- Step 1.** Select the desired **EDID** from the Source panel.
- Step 2.** Press the **Export** button and save the file to the computer.

Importing an EDID

Previously saved EDID file (*.EDID) can be uploaded to the user memory:

- Step 1.** Select the **User** tab on the Source panel and select a **memory slot**.
- Step 2.** Press the **Import** button below the Source panel.
- Step 3.** Browse the file in the opening window then press the **Open** button. The content of the EDID file is imported into the selected User memory.

ATTENTION! The new EDID overwrites the selected memory place.

Deleting EDID(s)

The EDID(s) from the User memory can be deleted as follows:

- Step 1.** Select the **User** tab on the Destination panel.
- Step 2.** Select the desired **memory slot(s)**; one or more can be selected (**Select All** and **Select None** buttons can be used).
- Step 3.** Press the **Clear selected** button to delete the EDID(s).

5.8. Advanced Settings

5.8.1. Common Settings (Encoder and Decoder)

The submenu contains two tabs: **Multicast** and **Unicast**. The currently valid mode is highlighted with yellow. Press the desired button to choose the mode and access the settings. [#unicast](#) [#multicast](#)

ATTENTION! When the mode is changed the device must be restarted; you will get a notification.

Network Settings [#network](#) [#ipaddress](#) [#dhcp](#)

The factory default IP address of the extender is set to get it from the DHCP server in the network. The drop-down list and the further parameters allow changing the network settings to the desired value.

ATTENTION! When the desired Network parameters are set, press the **Apply changes** button; the device will reboot.

Please use the port number 6107 for connecting to the device directly from a third-party application.

Upgrade Firmware [#firmwareversion](#)

For the details please see the [Firmware Upgrade](#) section.

Programmers' LW3 Terminal

See the [LW3 Terminal](#) section.

RS-232 Settings [#rs232](#) [#rs-232](#) [#serial](#)

The RS-232 serial data transmission is fully transparent between the Encoder and the connected Decoder devices. All data received on the serial port of the Decoders is transmitted to the serial port of the Encoder and vice versa: the data received on the serial port of the Encoder is transmitted to the serial port of all connected Decoders.

ATTENTION! The data transmission works only if the serial port parameters were set to the same values in all the devices: serial data sender/receiver and the VINX Encoder and Decoder devices.

See more information in the [Dante® Audio Output Interface](#) section.

USB Settings (Multicast Mode)

The **Encoder** displays the name of the currently connected Decoder.

The **Decoder** displays if the USB connection is established; press the button to acquire the connection if needed. [#usbkvm](#) [#kvm](#)

Restart and Factory Default Settings [#reboot](#) [#reset](#) [#restart](#)

Scroll down to these dedicated buttons. [#factory](#)

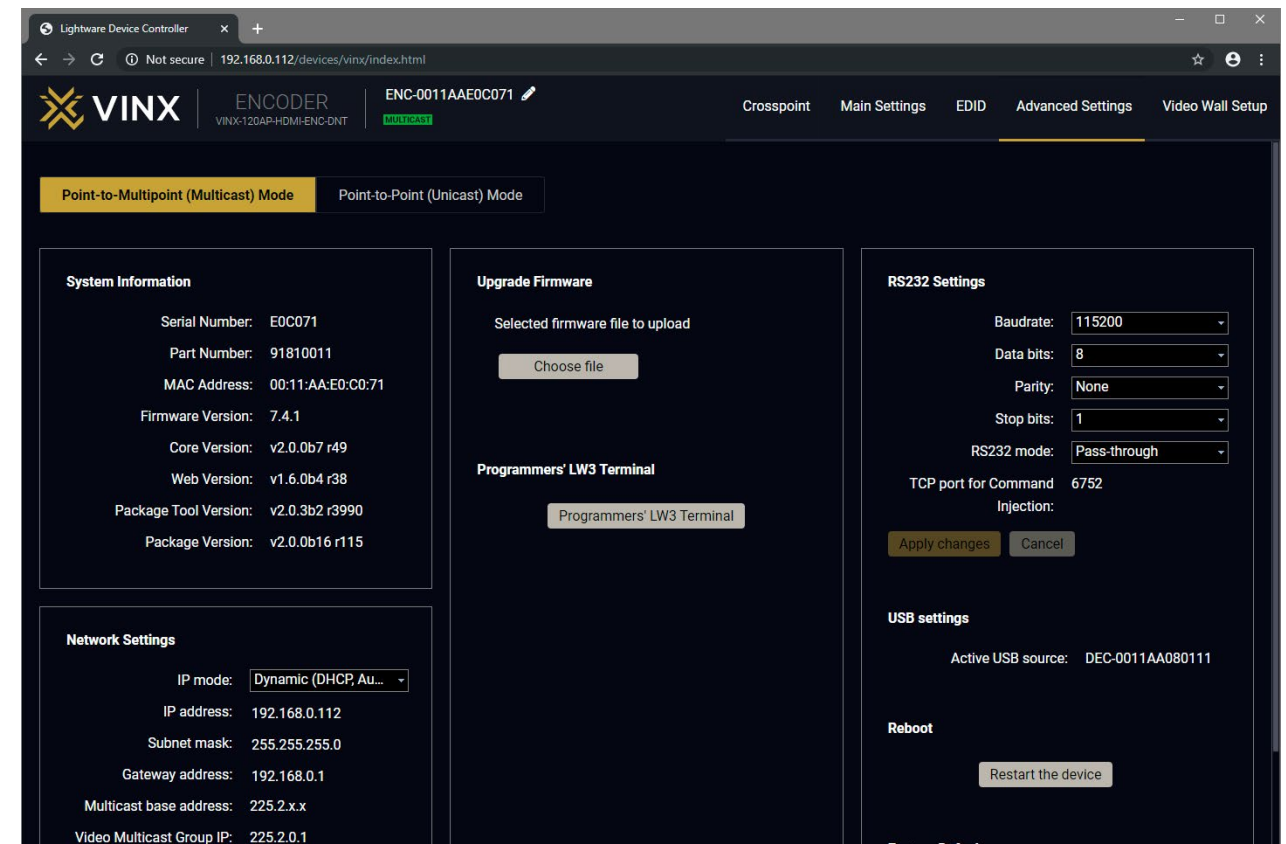

The Advanced Settings Menu of an Encoder in Multicast Mode

5.8.2. Decoder-related Settings

OSD Settings (the On-Screen Display Feature) *#osd*

Certain system messages can be displayed on the connected screen; the following are defined:

- **Enable OSD:** set it to 'ON' state to enable the OSD feature.
- **HDCP messages:** 'HDCP failed'
- **USB messages:** 'Requesting USB', 'Starting USB', 'Stopping USB'
- **Video quality messages:** 'Graphics mode', 'Movie mode'
- **Dither messages:** reserved
- **Other messages:** reserved

Press the **Apply changes** button and **restart** to save the new settings.

Keyboard Shortcuts

A keyboard connected to the USB 1.1 port of a Decoder can be used to change the assigned Encoder to another one. Thus, the input source of a Decoder can be changed quickly and easily.

INFO: The Video Stream ID of the Decoder is changed when a command is executed.

The shortcut can be set:

- to select a certain stream directly, or
- to select the next/previous stream in the list.

Setting (Changing) a Shortcut

Step 1. Open the web page of the desired Decoder and navigate to the **Advanced Settings** page.

Step 2. Connect an USB keyboard to that computer directly, or through the desired Decoder and the Encoder (make sure the Encoder is connected to the computer via USB).

Step 3. Place the cursor in the desired Shortcut box.

Step 4. Press the desired key combination; the new setting will be displayed and stored.

Executing a Command (Calling a Shortcut)

Connect the keyboard to an **USB 1.1 port** (not the USB 2.0!) of the desired Decoder. Press the key(s) **three times** quickly (within 750 ms).

Stream ID List *#videostreamid #streamid*

You can set a custom list of streams, thus, the Previous/Next stream shortcuts will select the streams in the desired order.

Scaler Settings *#scaler*

The same options as in the [Scaler settings](#) *#scaler* section.

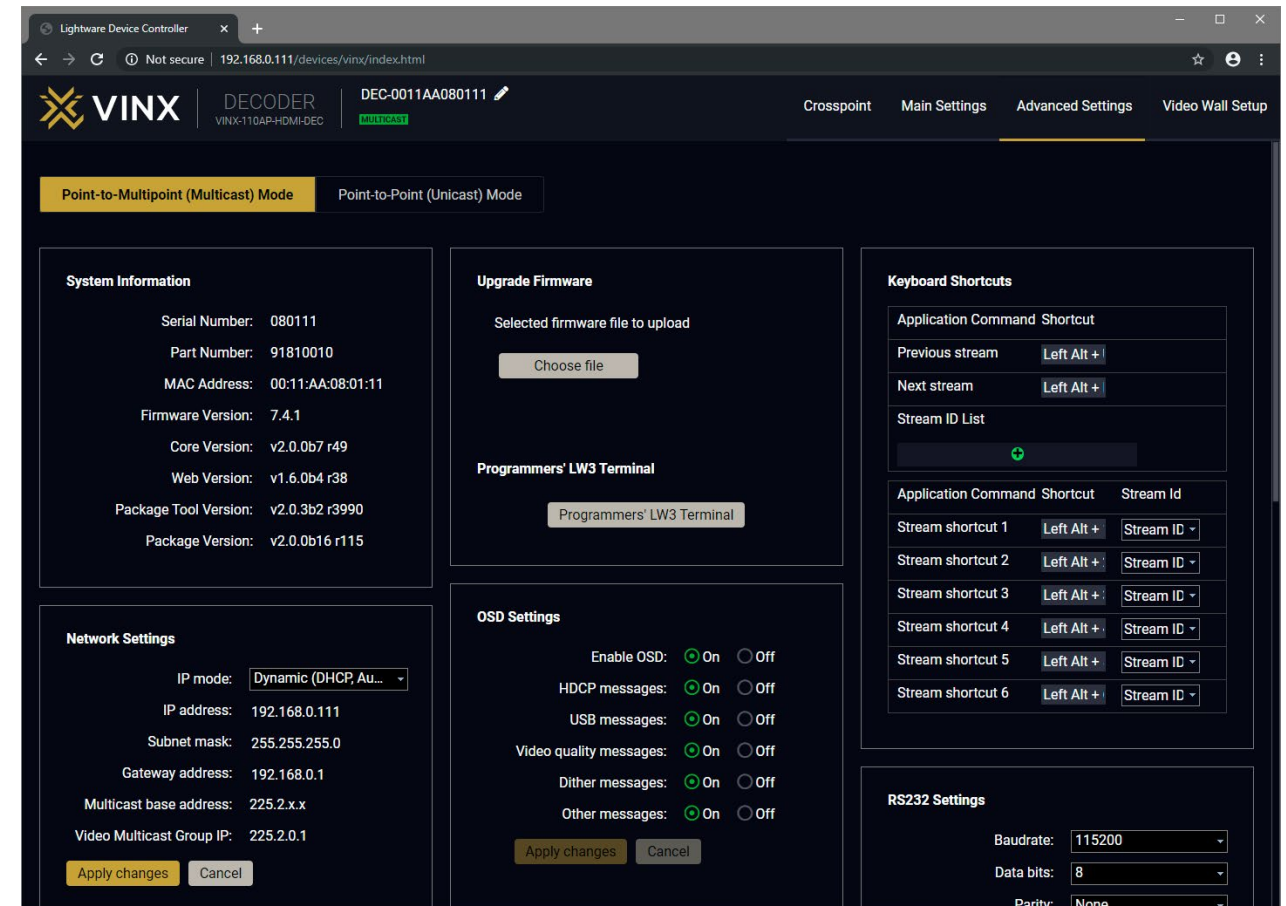

The Advanced Settings Menu of a Decoder in Multicast Mode

5.8.3. LW3 Terminal

This window is the surface of the Lightware Protocol 3 (LW3) tree with a terminal window. Commands and specific parameters (which are not available on the graphical user interface of the LDC) can be run and set. The introduction of the LW3 protocol and the most important commands can be found in the [Programmer's Reference](#) section.

Legend *#terminal*

- 1 **LW3 Protocol Help** Displaying the most important information about LW3 protocol commands in a new window.
- 2 **Terminal Window** Commands and responses with time and date stamps are listed in this window. Sent command starts with '>' character, received response starts with '<' character. The content of the window can be emptied by the **Clear** button. If the **Autoscroll** option is ticked, the list is scrolled automatically when a new line is added.
- 3 **Edit Mode** The default appearance is the read-only mode. If you want to modify the values or parameters, tick the option. You will be prompted to confirm your selection.
- 4 **Protocol Tree** LW3 protocol tree; select an item to see its content.
- 5 **Node List** The parameters and nodes of the selected item in the protocol tree are shown.
 - **Manual** button: displaying the manual (short description) of the node in a pop-up window.
 - **Set** button: Saving the value/parameter typed in the textbox.
 - **Call** button: Executing the method, e.g. reloading the factory default settings.
- 6 **Warning Mode** If this option is enabled, a warning window pops up when you enable the **Edit mode**.
- 7 **Command Line** Type the desired command and execute it by pressing the **Send** button.

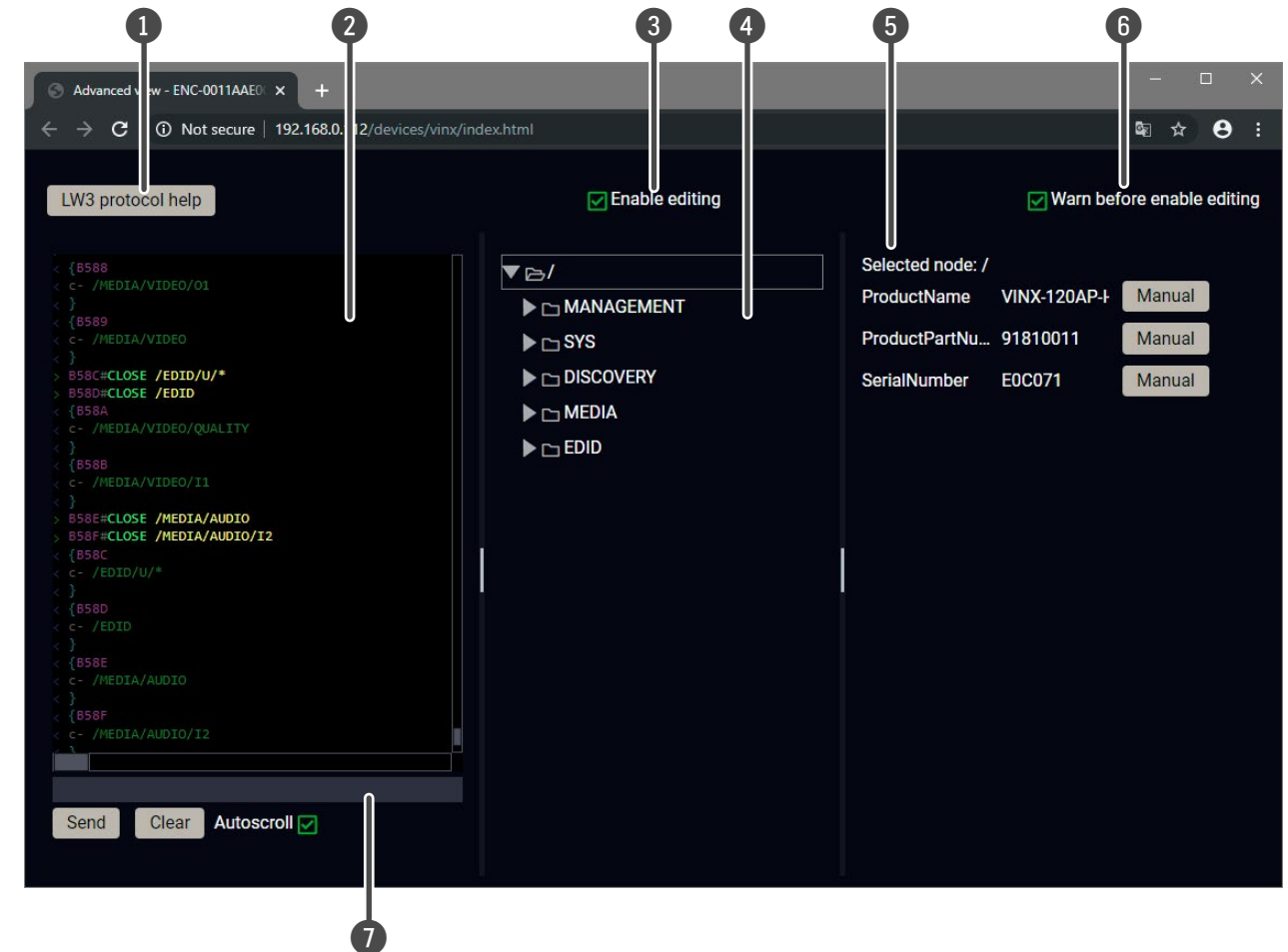

The Terminal Window

5.9. Video Wall Setup

ATTENTION! This tab is displayed only when the device is in Multicast mode. Although changing parameters usually takes effect within an acceptable period of time, it might happen that feedback is not received and not visible on the web page for several seconds.

Basic Rules *#videowall*

- One Decoder can be a part of only one video wall.
- The video wall must have a unique name within a system; the length of the name shall not exceed 24 characters.
- The video wall parameters are stored in the LW3 protocol tree of the Decoders but you can also create/access it in the Encoder.

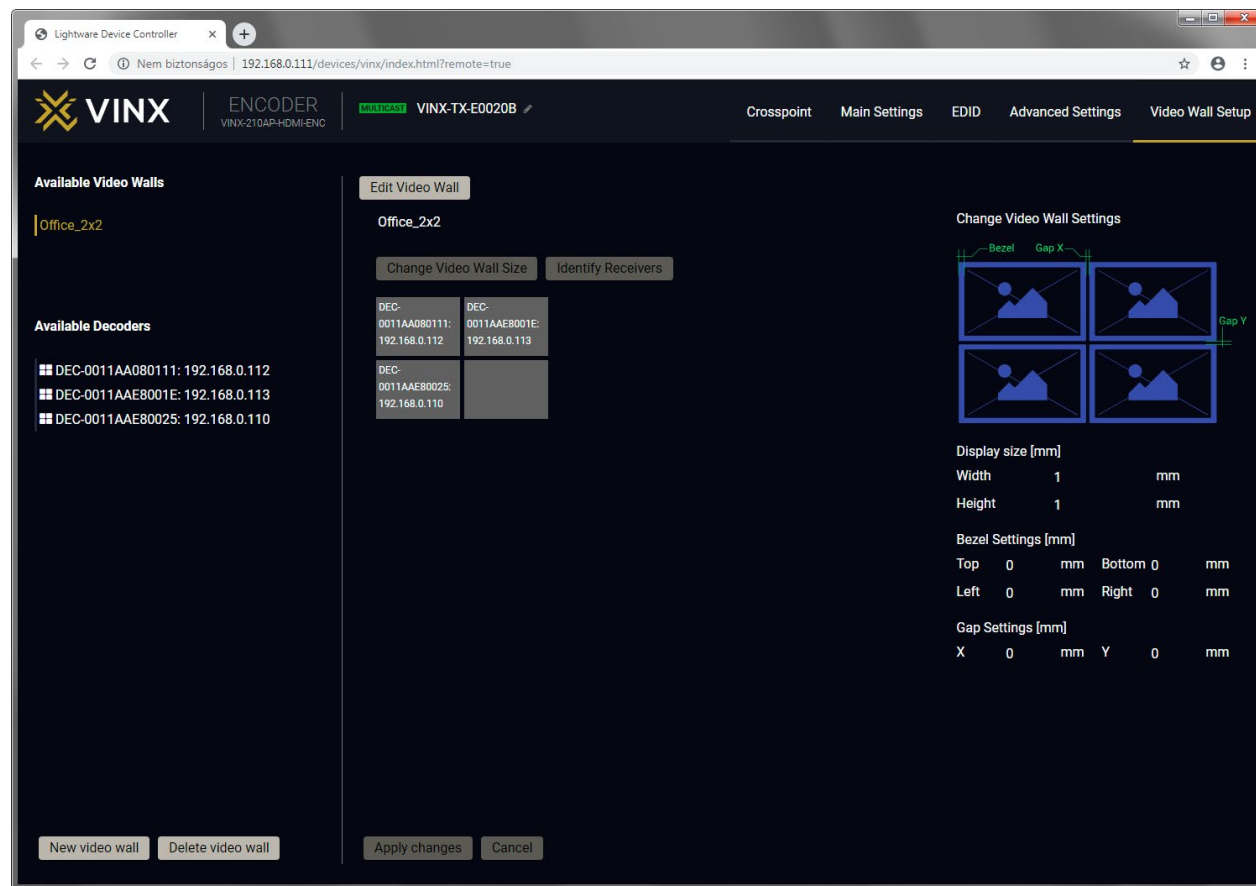

The Video Wall Setup Page

5.9.1. Creating a Video Wall

- Step 1.** Navigate to the **Video Wall Setup** page.
- Step 2.** Press the **New video wall** button. Enter the desired name of the wall (press the pencil icon  to change) and press the **Enter** or click on the pencil icon.
- Step 3.** Press the **Change Video Wall Size** button to set the exact size of the wall. A new window will pop up, click on the desired size (see besides).
- Step 4.** Drag and drop the Decoders to the desired place in the wall.
- Step 5.** Press the **Apply changes** button to save the settings.

ATTENTION! A New video wall is stored only when at least one Decoder is linked to the wall.

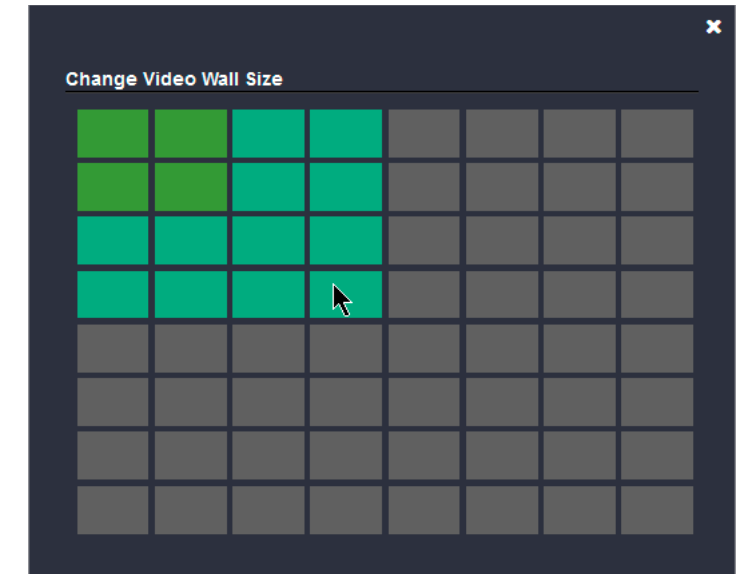

5.9.2. Identify the Decoders

The Decoders of a video wall can be identified by pressing the **Identify Receivers** button. In this case, the IP address and the position in the Video wall are displayed on the connected screens.

Identify Receivers

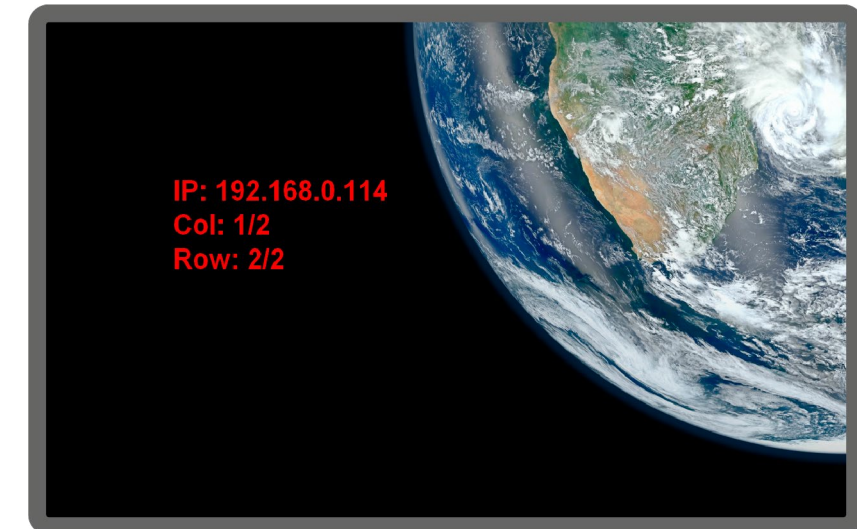

5.9.3. Gap and Bezel Settings

ATTENTION! Always press the **Apply changes** button if you want to save the changes of the below mentioned parameters.

DEFINITION: Hereby defined **Gap** means the physical distance between the edges of the display devices – see the attached figure.

DEFINITION: The **Bezel** means the thickness of the Display device's frame – see the attached figure.

In certain cases, the dimensions of the sinks and the arrangement of the video wall requires special parameters to set. The Gap and Bezel parameters allow setting the non-visible areas (between the display devices) of the image:

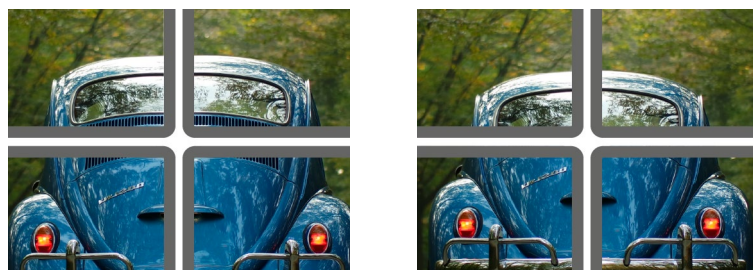

No Gap (left) and Manually Set Gap (right)

- **No Gap:** The left figure shows that no gap is defined. In this case, the whole image is shown on the screens but the image looks a bit distorted.
- **Defined Gap:** The right figure shows that gap is defined, therefore, some part of the image is not visible, but the appearance of the overall image is more realistic.

Set the bezel and gap parameters which suit the best for the current image content.

The following parameters can be set:

- **Display Size** (width and height): the physical size (dimensions) of the screen (screen size + bezel).
- **Bezel Settings** (top, bottom, left, right): the physical size (thickness) of the bezel.
- **Gap Settings** (horizontal, vertical): the distance of the displays (see the following section).

INFO: If the Bezel and Gap values are set to zero the Display size values (dimensions) do not matter.

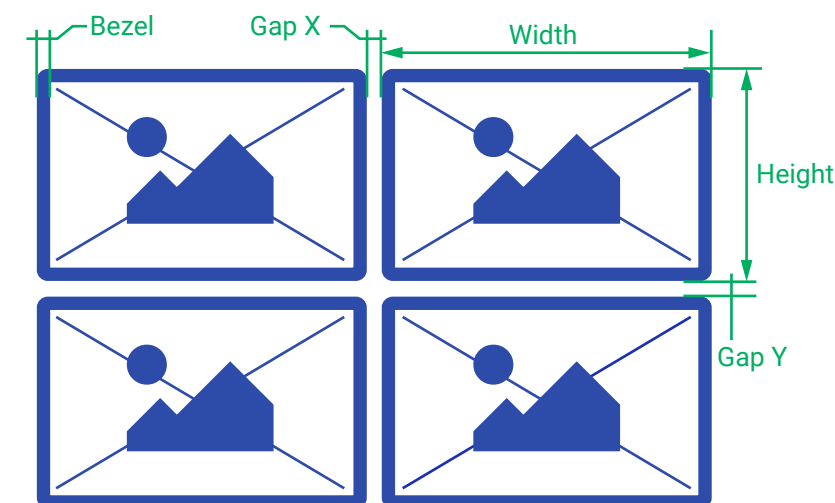

5.9.4. Modifying a Video Wall

The Name of the Video Wall

Step 1. Press the **Edit Video Wall** button.

Step 2. Change the name of the video wall and press the **Apply changes** button.

Changing the Layout of the Decoders

Step 1. Press the **Edit Video Wall** button.

Step 1. Drag and drop a Decoder to the below indicated red colored (hidden) place; the device will be removed from the wall.

Step 2. Another Decoder can be dragged and dropped to the empty place.

Step 3. Press the **Apply changes** button to save the settings.

ATTENTION! If you reduce the size of an existing video wall, the Decoders which would be outside of the new area show the original picture.

Changing the Gap and Bezel Settings

Step 1. Press the **Edit Video Wall** button.

Step 2. Set the desired gap and bezel values and press the **Apply changes** button to save the settings.

5.9.5. Deleting a Video Wall

Step 1. Select the video wall from the list.

Step 2. Click on the **Delete video wall** button and confirm in the pop-up window. The original image will be displayed on all connected Decoders.

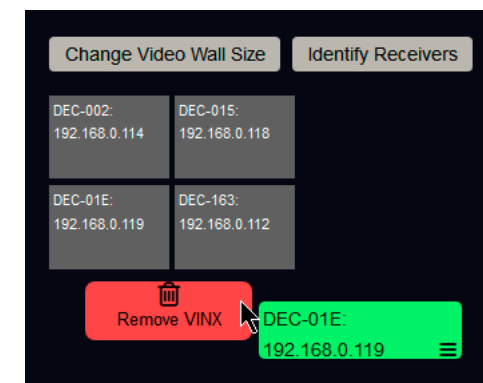

6

Programmer's Reference

The device can be controlled through Lightware 3 (LW3) protocol commands to ensure the compatibility with other Lightware products. The supported LW3 commands are described in this chapter.

- ▶ [OVERVIEW](#)
- ▶ [INSTRUCTIONS FOR THE TERMINAL APPLICATION USAGE](#)
- ▶ [PROTOCOL RULES](#)
- ▶ [SYSTEM COMMANDS](#)
- ▶ [NETWORK CONFIGURATION](#)
- ▶ [ENCODER-RELATED COMMANDS](#)
- ▶ [DECODER-RELATED COMMANDS](#)
- ▶ [AUDIO-RELATED COMMANDS](#)
- ▶ [SERIAL PORT SETTINGS](#)
- ▶ [ARRANGING THE EXTENDERS TO GROUPS](#)
- ▶ [VIDEO WALL SETTINGS](#)
- ▶ [SETTING UP A VIDEO WALL \(EXAMPLE\)](#)
- ▶ [CROSSPOINT SWITCHING EXAMPLES](#)
- ▶ [EDID MANAGEMENT \(ENCODER\)](#)
- ▶ [LW3 COMMANDS - QUICK SUMMARY](#)

6.1. Overview

The Lightware Protocol #3 (LW3) is implemented in almost all new Lightware devices (matrix switchers, signal extenders and distribution amplifiers) since 2012. The protocol is ASCII-based and all commands are terminated with a carriage return (Cr, '\r') and line feed (Lf, '\n') pair. It is organized as a tree structure that provides outstanding flexibility and user-friendly handling with 'nodes', 'properties' and 'methods'. The **Advanced View** of the Lightware Device Controller software is the perfect tool for browsing and learning how the LW3 protocol can be used in practice.

6.2. Instructions for the Terminal Application Usage

Terminal Application

The LW2 protocol commands can be applied to the receiver using a terminal application. You need to install one of them to your control device, for example **Putty** or **CLI**. `#terminal`

Establishing Connection

Follow the steps for establishing connection to the receiver:

- Step 1.** Connect the receiver to a LAN over Ethernet.
- Step 2.** Open the terminal application (e.g. Putty).
- Step 3.** Add the **IP address** of the device (default: 192.168.0.100) and the **port number (6107)**.
- Step 4.** Select the **Raw** connection type, and open the connection.

Once the terminal window is opened, you can enter the LW3 protocol commands which are listed in the following sections.

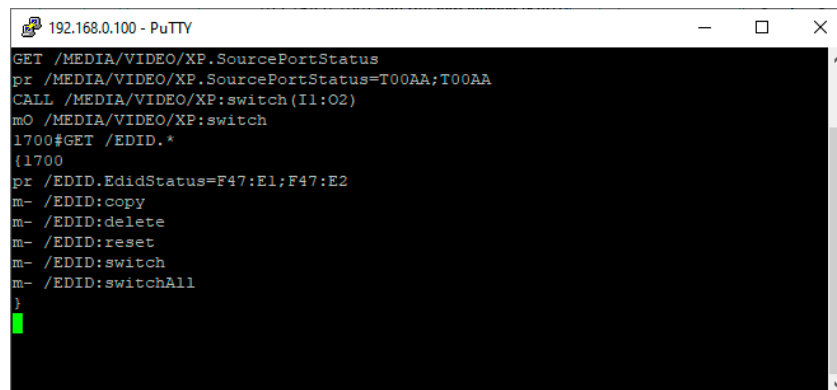
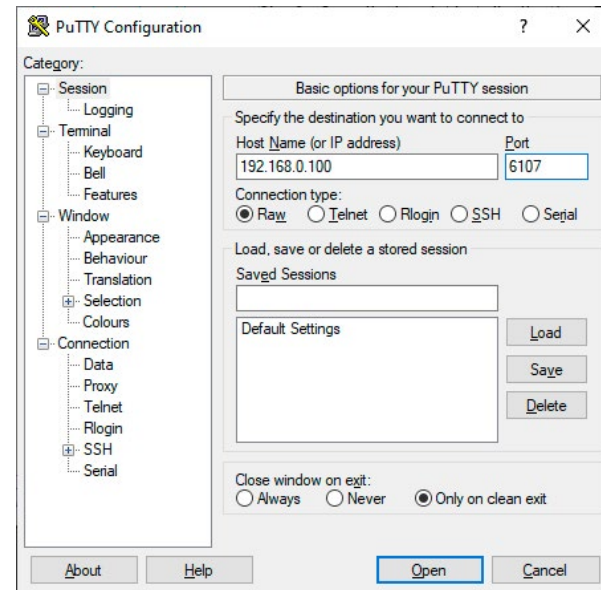

LW3 protocol command communication in a terminal window

6.3. Protocol Rules

6.3.1. The LW3 Tree Structure

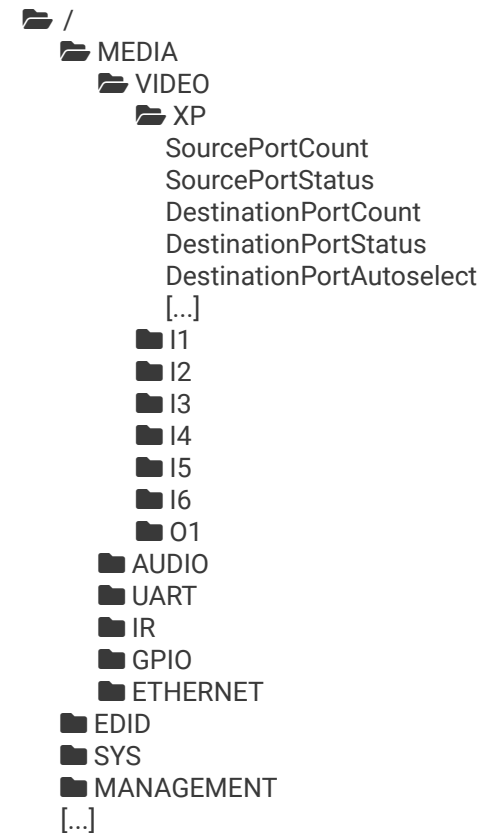

6.3.2. The LW3 Command Structure

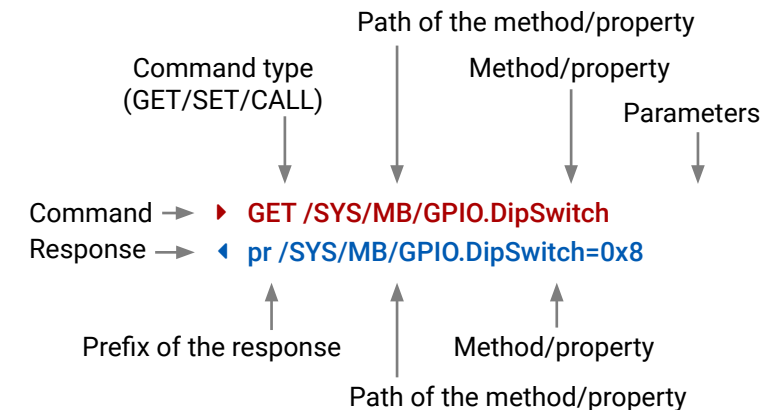

6.3.3. Legend for the Control Commands

Command and Response – Example

- ▶ GET•/SYS/MB/GPIO.DipSwitch
- ◀ pr•/SYS/MB/GPIO.DipSwitch=<DIP_value>

Format	Description
<in>	Input port number
<out>	Output port number
<port>	Input or output port number
<loc>	Location number
▶	Sent command
◀	Received response
•	Space character

Further not listed <parameters> are defined at each commands.

6.3.4. General Rules

- All names and parameters are **case-sensitive**.
- The nodes are separated by a slash ("/) character.
- The node name can contain the elements of the English alphabet and numbers.
- Use the **TCP port no. 6107** when using LW3 protocol over Ethernet.
- When a command is issued by the device, the received response cannot be processed by the CPU.
- The path of a node has to contain all parent nodes from the root node.

6.3.5. Command Types

GET command

The **GET** command can be used to get the child nodes, properties and methods of a specific node. It can also be used to get the value of a property. Use the dot character (.) when addressing a property:

- ▶ GET /.SerialNumber
- ◀ pr /.SerialNumber=87654321

GETALL command

The **GETALL** command can be used to get all child nodes, properties and methods of a node with one command.

- ▶ GETALL /MEDIA/UART
- ◀ n- /MEDIA/VIDEO/I1
- ◀ n- /MEDIA/VIDEO/O1
- ◀ n- /MEDIA/VIDEO/QUALITY
- ◀ pr /MEDIA/VIDEO.I1=I1
- ◀ pr /MEDIA/VIDEO.O1=O1
- ◀ pr /MEDIA/VIDEO.PortCount=2

SET command

The **SET** command can be used to modify the value of a property. Use the dot character (.) when addressing the property:

- ▶ SET /MEDIA/VIDEO/QUALITY.QualityMode=0
- ◀ pw /MEDIA/VIDEO/QUALITY.QualityMode=0

CALL command

A method can be invoked by the **CALL** command. Use the colon character (:) when addressing the method:

- ▶ CALL /MEDIA/VIDEO/QUALITY:applySettings(true)
- ◀ m0 /MEDIA/VIDEO/QUALITY:applySettings

6.3.6. Prefix Summary

DEFINITION: The prefix is a 2-character long code that describes the type of the response.

The following prefixes are defined in the LW3 protocol:

Prefix	Description
n-	a node
nE	an error for a node
nm	a manual of a node
ns	a child node of a node
pr	a read-only property
pw	read-write property
pE	an error for the property
pm	a manual for the property
m-	a method
mO	a response after a success method execution
mF	a response after a failed method execution
mE	an error for a method
mm	a manual for a method

6.3.7. Error Messages

There are several error messages defined in the LW3 protocol, all of them have a unique error number.

- ▶ SET /MEDIA/UART/P1.Baudrate=9
- ◀ pE /MEDIA/UART/P1.Baudrate %E004:Invalid value

6.3.8. Escaping

DEFINITION: An escape sequence is a sequence of characters that does not represent itself when used inside a character or string literal, but is translated into another character or a sequence of characters.

Property values and method parameters can contain characters which are used as control characters in the protocol. They must be escaped. The escape character is the backslash ('\') and escaping means injecting a backslash before the character that should be escaped (like in C language).

Control characters are the following: \ { } # % () \r \n \t

The **original** message:

```
CALL /MEDIA/UART/P1:sendMessage(Set(01))
```

The **escaped** message:

```
CALL /MEDIA/UART/P1:sendMessage(Set\01\))
```

6.3.9. Signature

DEFINITION: The signature is a four-digit-long hexadecimal value that can be optionally placed before every command to keep a command and the corresponding responses together as a group.

Each line is terminated with a carriage return (Cr, '\r') and line feed (Lf, '\n') characters. In several cases the number of the lines in the response cannot be determined in advance, e.g. the client is intended waiting for the whole response and also wants to be sure, that the received lines belong together and to the same command. In these cases, a special feature the 'signature' can be used. In these cases, the response to that particular command will also be preceded by the signature, and the corresponding lines will be between brackets:

```
▶ 1700#GET /EDID.*
◀ {1700
◀ pr /EDID.EdidStatus=F89:E1;D1:E2;D1:E3;D1:E4;F89:E5
◀ m- /EDID:copy
◀ m- /EDID:delete
◀ m- /EDID:reset
◀ m- /EDID:switch
◀ m- /EDID:switchAll
◀ }
```

INFO: The lines of the signature are also Cr and Lf terminated.

6.3.10. Subscription

DEFINITION: Subscribe to a node means that the user will get a notification if any of the properties of the node is changed.

A user can subscribe to any node. These notifications are asynchronous messages and they are useful to keep the client application up to date, without receiving any unwanted information. When the user does not want to be informed about the changes anymore, he can simply unsubscribe from the node.

ATTENTION! The subscriptions are handled separately for connections. Hence, if the connection is terminated all registered subscriptions are deleted. After closing a connection the subscribe command has to be sent in order to get the notifications of the changes on that connection.

Subscribe to a Node

- ▶ OPEN /MEDIA/VIDEO
- ◀ o- /MEDIA/VIDEO

Get the Active Subscriptions

- ▶ OPEN
- ◀ o- /MEDIA/VIDEO
- ◀ o- /EDID
- ◀ o- /DISCOVERY

Subscribe to Multiple Nodes

- ▶ OPEN /MEDIA/VIDEO/*
- ◀ o- /MEDIA/VIDEO/*

Unsubscribe from a Node

- ▶ CLOSE /MEDIA/VIDEO
- ◀ c- /MEDIA/VIDEO

Unsubscribe from Multiple Nodes

- ▶ CLOSE /MEDIA/VIDEO/*
- ◀ c- /MEDIA/VIDEO/*

6.3.11. Notifications about the Changes of the Properties

When the value of a property is changed and the user is subscribed to the node, which the property belongs to, an asynchronous notification is generated. This notification is called as the 'change message'. The format of such a message is very similar to the response for the **GET** command:

◀ CHG /EDID.EdidStatus=F48:E1

A Short Example of How to Use the Subscription

There are two independent users controlling the device through two independent connections (**Connection #1** and **Connection #2**). The events in the rows occur after each other.

▶ OPEN /MEDIA/VIDEO/QUALITY	}	Connection #1
◀ o- /MEDIA/VIDEO/QUALITY		
▶ GET /MEDIA/VIDEO/Quality.QualityMode	}	Connection #2
◀ pm /MEDIA/VIDEO/QUALITY.QualityMode=graphic		
▶ GET /MEDIA/VIDEO/Quality.QualityMode	}	Connection #2
◀ pm /MEDIA/VIDEO/QUALITY.QualityMode=graphic		
▶ SET /MEDIA/VIDEO/Quality.QualityMode=movie	}	Connection #1
◀ pw /MEDIA/VIDEO/QUALITY.QualityMode=movie		
◀ CHG /MEDIA/VIDEO/QUALITY.QualityMode=movie	→	Connection #1

Explanation: The first user (**Connection #1**) set a subscription to a node. Later the other user (**Connection #2**) made a change, and thanks for the subscription, the first user got a notification about the change.

6.4. System Commands

6.4.1. Querying the Product Name

Command and Response

- ▶ GET /.ProductName
- ◀ pr /.ProductName=<Product_name>

Parameters

The <Product_name> is the type of the device: read-only parameter and cannot be modified.

Example

- ▶ GET /.ProductName
- ◀ pr /.ProductName=VINX-120-HDMI-ENC

6.4.2. Setting the Device Label

Unique name can be set which will be visible when the given device is listed in the built-in web page of other VINX devices. Furthermore, the name is listed when browsing the client list of a DHCP server.

ATTENTION! This property is a writable parameter and not the same as the **ProductName**.

Command and Response *#label #devicelabel*

- ▶ SET /SYS/MB.DeviceLabel=<Custom_name>
- ◀ pw /SYS/MB.DeviceLabel=<Custom_name>

Parameters

The <Custom_name> may consist of ASCII characters and can be 32 characters length. Longer names are truncated.

Example

- ▶ SET /SYS/MB.DeviceLabel=Enc_80
- ◀ pw /SYS/MB.DeviceLabel=Enc_80

6.4.3. Querying the Serial Number

Command and Response

- ▶ GET /.SerialNumber
- ◀ pr /.SerialNumber=<serial_nr>

Example

- ▶ GET /.SerialNumber
- ◀ pr /.SerialNumber=87654321

6.4.4. Querying the Package Version

Command and Response *#firmwareversion*

- ▶ GET /SYS/MB.PackageVersion
- ◀ pr /SYS/MB.PackageVersion=<package_version>

Example

- ▶ GET /SYS/MB.PackageVersion
- ◀ pr /SYS/MB.PackageVersion=v1.4.0b7 r90

6.4.5. Resetting the Device

The extender can be restarted; the current connections (RS-232, USB, etc...) will be terminated.

Command and Response *#reboot #restart #reset*

- ▶ CALL /SYS:reset()
- ◀ m0 /SYS:Reset

Example

- ▶ CALL /SYS:reset()
- ◀ m0 /SYS:reset

6.4.6. Restoring the Factory Default Settings

Command and Response *#factory*

- ▶ CALL /SYS:factoryDefaults()
- ◀ m0 /SYS:factoryDefaults=

Example

- ▶ CALL /SYS:factoryDefaults()
- ◀ m0 /SYS:factoryDefaults=

The device is restarted, the current connections are terminated, the default settings are restored. See the complete list in the [Delay in the Video Transmission](#) section.

6.5. Network Configuration

ATTENTION! When you change a network property the new value is stored but the `applySettings` method must be called always to apply the new settings. When two or more serial parameters are changed the `applySettings` method is enough to call once as a final step; it results the extender to reboot.

6.5.1. Querying the IP Address

Command and Response *#network #ipsettings #dhcp*

- ▶ GET•/MANAGEMENT/NETWORK.IpAddress
- ◀ pr•/MANAGEMENT/NETWORK.IpAddress=<IP_Address>

Example

- ▶ GET /MANAGEMENT/NETWORK.IpAddress
- ◀ pr /MANAGEMENT/NETWORK.IpAddress=192.168.0.100

6.5.2. Querying the IP Setup Mode (FW 2.x.x)

DIFFERENCE: The following command is valid with firmware package 2.0.0 or newer.

Command and Response

- ▶ GET•/MANAGEMENT/NETWORK.IpSetupMode
- ◀ pw•/MANAGEMENT/NETWORK.IpSetupMode=<IP_mode>

Parameters

Identifier	Parameter description	Parameter values
<IP_mode>	The currently applied IP setup mode.	<p>static: using a static IP address, gateway and subnet mask entered by the user.</p> <p>autoip: generating and IP address from the AutoIP range (169.254.x.x) even if a DHCP server is available.</p> <p>dhcponeshot: trying to get the IP address, gateway and subnet mask from a DHCP server. If no answer arrives, fallback to autoIP.</p> <p>dhcpwautoip: (factory default setting) similar to dhcponeshot, but keep on with DHCP discovery queries even after AutoIP fallback. If there is a DHCP response, the IP parameters are set accordingly.</p> <p>dhcpwoautoip: try to get the IP address, gateway and subnet mask from a DHCP server without ever falling back to AutoIP mode.</p>

Example

- ▶ GET /MANAGEMENT/NETWORK.IpSetupMode
- ◀ pw /MANAGEMENT/NETWORK.IpSetupMode=static

Explanation

Static IP address (fix IP) setting is valid.

6.5.3. Setting the IP Setup Mode (FW 2.x.x)

DIFFERENCE: The following command is valid with firmware package 2.x.x.

Command and Response

- ▶ SET•/MANAGEMENT/NETWORK.IpSetupMode
- ◀ pw•/MANAGEMENT/NETWORK.IpSetupMode=<IP_mode>

Parameters

See the previous section.

Example

- ▶ SET /MANAGEMENT/NETWORK.IpSetupMode=autoip
- ◀ pw /MANAGEMENT/NETWORK.DhcpEnabled=autoip
- ▶ CALL /MANAGEMENT/NETWORK:applySettings(1)
- ◀ mO /MANAGEMENT/NETWORK:applySettings

INFO: The `applySettings` method will save and apply the new value and results the extender to reboot.

Explanation

The IP address is set in the 169.254.x.x range by the extender based on Auto IP (Automatic Private IP Addressing) method.

6.5.4. Querying the DHCP State (FW 1.x.x)

DIFFERENCE: The following command is valid with firmware package 1.x.x.

Command and Response

- ▶ GET•/MANAGEMENT/NETWORK.DhcpEnabled
- ◀ pw•/MANAGEMENT/NETWORK.DhcpEnabled=<DHCP_state>

Parameters

If the <DHCP_state> parameter is **0** (or **false**) the device is set to apply a static IP address. If the value is **1** (or **true**) the device is set to get a dynamic IP address from the DHCP server in the network.

Example

- ▶ GET /MANAGEMENT/NETWORK.DhcpEnabled
- ◀ pw /MANAGEMENT/NETWORK.DhcpEnabled=true

Explanation

The IP address assignment is dynamic, the device gets the IP address from the DHCP server.

6.5.5. Setting the DHCP State (FW 1.x.x)

DIFFERENCE: The following command is valid with firmware package 1.x.x.

Command and Response

- ▶ SET /MANAGEMENT/NETWORK.DhcpEnabled=<DHCP_state>
- ◀ pw /MANAGEMENT/NETWORK.DhcpEnabled=<DHCP_state>

Parameters

See the previous section.

Example

- ▶ SET /MANAGEMENT/NETWORK.DhcpEnabled=0
- ◀ pw /MANAGEMENT/NETWORK.DhcpEnabled=false
- ▶ CALL /MANAGEMENT/NETWORK:applySettings(1)
- ◀ mO /MANAGEMENT/NETWORK:applySettings

INFO: The **applySettings** method will save and apply the new value and results the extender to reboot.

Explanation

The IP address assignment is set to static, thus, you have to set it manually.

6.5.6. Setting a Static IP Address

DIFFERENCE: Make sure the IP address setting is static:
 In case of FW 1.x.x: when the **DhcpEnabled** property is **false** you can set a static IP address.
 In case of FW 2.x.x: when the **IpSetupMode** property is **static** you can set a static IP address.

Command and Response

- ▶ SET /MANAGEMENT/NETWORK.StaticIpAddress=<IP_address>
- ◀ pw /MANAGEMENT/NETWORK.StaticIpAddress=<IP_address>

Example

- ▶ SET /MANAGEMENT/NETWORK.StaticIpAddress=192.168.0.85
- ◀ pw /MANAGEMENT/NETWORK.StaticIpAddress=192.168.0.85
- ▶ CALL /MANAGEMENT/NETWORK:applySettings(1)
- ◀ mO /MANAGEMENT/NETWORK:applySettings

INFO: The **applySettings** method will save and apply the new value and results the extender to reboot.

6.5.7. Querying the Subnet Mask

Command and Response

- ▶ GET /MANAGEMENT/NETWORK.NetworkMask
- ◀ pr /MANAGEMENT/NETWORK.NetworkMask=<subnet_mask>

Example

- ▶ GET /MANAGEMENT/NETWORK.NetworkMask
- ◀ pr /MANAGEMENT/NETWORK.NetworkMask=255.255.255.0

6.5.8. Setting a Static Subnet Mask

DIFFERENCE: Make sure the IP address setting is static:
 In case of FW 1.x.x: when the **DhcpEnabled** property is **false** you can set a static IP address.
 In case of FW 2.x.x: when the **IpSetupMode** property is **static** you can set a static IP address.

Command and Response

- ▶ SET /MANAGEMENT/NETWORK.StaticNetworkMask=<subnet_mask>
- ◀ pw /MANAGEMENT/NETWORK.StaticNetworkMask=<subnet_mask>

Example

- ▶ SET /MANAGEMENT/NETWORK.StaticNetworkMask=255.255.255.0
- ◀ pw /MANAGEMENT/NETWORK.StaticNetworkMask=255.255.255.0
- ▶ CALL /MANAGEMENT/NETWORK:applySettings(1)
- ◀ mO /MANAGEMENT/NETWORK:applySettings

INFO: The **applySettings** method will save and apply the new value and results the extender to reboot.

6.5.9. Querying the Gateway Address

Command and Response

- ▶ GET /MANAGEMENT/NETWORK.GatewayAddress
- ◀ pr /MANAGEMENT/NETWORK.GatewayAddress=<gw_address>

Example

- ▶ GET /MANAGEMENT/NETWORK.GatewayAddress
- ◀ pr /MANAGEMENT/NETWORK.GatewayAddress=192.168.0.1

6.5.10. Setting a Static Gateway Address

DIFFERENCE: Make sure the IP address setting is static:

In case of FW 1.x.x: when the **DhcpEnabled** property is **false** you can set a static IP address.

In case of FW 2.x.x: when the **IpSetupMode** property is **static** you can set a static IP address.

Command and Response

- ▶ SET•/MANAGEMENT/NETWORK.StaticGatewayAddress=<gateway_address>
- ◀ pw•/MANAGEMENT/NETWORK.StaticGatewayAddress=<gateway_address>

Example

- ▶ SET /MANAGEMENT/NETWORK.StaticGatewayAddress=192.168.0.5
- ◀ pw /MANAGEMENT/NETWORK.StaticGatewayAddress=192.168.0.5
- ▶ CALL /MANAGEMENT/NETWORK:applySettings(1)
- ◀ mO /MANAGEMENT/NETWORK:applySettings

INFO: The **applySettings** method will save and apply the new value and results the extender to reboot.

6.6. Encoder-related Commands

6.6.1. Querying the Input Video Signal Presence

The input port can be queried if video signal is present.

Command and Response #status

- ▶ GET•/MEDIA/VIDEO/<in>.SignalPresent
- ◀ pr•/MEDIA/VIDEO/<in>.SignalPresent=<signal_present>

Parameters

If the <signal_present> parameter is **0**, then signal is not present at the port. If the value is **1**, then signal is present at the input.

Example

- ▶ GET /MEDIA/VIDEO/I1.SignalPresent
- ◀ pr /MEDIA/VIDEO/I1.SignalPresent=1

6.6.2. Querying the Resolution of the Input Video Signal

The resolution and the refresh rate of the incoming video signal can be queried.

Command and Response #resolution

- ▶ GET•/MEDIA/VIDEO/<in>.Resolution
- ◀ pr•/MEDIA/VIDEO/<in>.Resolution=<resolution@refresh_rate>

Example

- ▶ GET /MEDIA/VIDEO/I1.Resolution
- ◀ pr /MEDIA/VIDEO/I1.Resolution=1280x720@60Hz

6.6.3. Querying the Active Input Port

DIFFERENCE: Below command is valid for VINX-210AP-HDMI-ENC device only.

Command and Response

- ▶ GET•/MEDIA/VIDEO.InputSource
- ◀ pr•/MEDIA/VIDEO.InputSource=<source_ID>

Parameters

Identifier	Parameter description	Parameter values
<source_ID>	Identifier of the video input port	0: unknown 1: HDMI 2: VGA

Example

- ▶ GET /MEDIA/VIDEO.InputSource
- ◀ pr /MEDIA/VIDEO.InputSource=1

6.6.4. Querying the Video Input Selection Mode

DIFFERENCE: Below command is valid for VINX-210AP-HDMI-ENC device only.

Command and Response *#inputselection*

- ▶ GET•/MEDIA/VIDEO.SelectionMode
- ◀ pw•/MEDIA/VIDEO.SelectionMode=<sel_mode>

Parameters

Identifier	Parameter description	Parameter values
<sel_mode>	The currently applied input selection method.	0: Auto 1: HDMI 2: VGA

Auto mode: the first connected source shall remain active as long as signal is present on the respective input. If sync is lost for at least 3 seconds, a switch over to the other source shall occur. No automatic switch back to the original input shall occur when the signal is restored.

Example

- ▶ GET /MEDIA/VIDEO.SelectionMode
- ◀ pw /MEDIA/VIDEO.SelectionMode=0

6.6.5. Setting the Video Input Selection Mode

DIFFERENCE: Below command is valid for VINX-210AP-HDMI-ENC device only.

Command and Response

- ▶ SET•/MEDIA/VIDEO.SelectionMode=<sel_mode>
- ◀ pw•/MEDIA/VIDEO.SelectionMode=<sel_mode>

Parameters

Identifier	Parameter description	Parameter values
<sel_mode>	The currently applied input selection method.	0: Auto (see the details in previous section) 1: HDMI 2: VGA

Example

- ▶ SET /MEDIA/VIDEO.SelectionMode=1
- ◀ pw /MEDIA/VIDEO.SelectionMode=1

6.6.6. Querying the Video Quality Mode

When the network bandwidth is not enough to transmit the video signal the following modes are available in the Encoder:

- **Movie mode** (Lower image quality @ Less bandwidth): The image quality is adjusted to the available bandwidth. If the bandwidth is decreased the image quality will be lower, but the video streaming is continuous.
- **Graphics mode** (Best image quality @ High bandwidth): The image quality is kept at a high level. If the bandwidth is decreased the image quality does not change, but frame drop may appear.

Command and Response *#qualitymode #videoquality*

- ▶ GET•/MEDIA/VIDEO/QUALITY.QualityMode
- ◀ pw•/MEDIA/VIDEO/QUALITY.QualityMode=<quality_mode>

Parameters

The value of the <quality_mode> parameter shows the current mode setting: **movie** or **graphic**.

Example

- ▶ GET /MEDIA/VIDEO/QUALITY.QualityMode
- ◀ pw /MEDIA/VIDEO/QUALITY.QualityMode=movie

6.6.7. Setting the Video Quality Mode

The video quality mode can be set in the Encoder (see the previous section for details about the modes):

Command and Response

- ▶ SET•/MEDIA/VIDEO/QUALITY.QualityMode=<quality_mode>
- ◀ pw•/MEDIA/VIDEO/QUALITY.QualityMode=<quality_mode>

Parameters

See the previous section.

Example

- ▶ SET /MEDIA/VIDEO/QUALITY.QualityMode=graphic
- ◀ pw /MEDIA/VIDEO/QUALITY.QualityMode=graphic

6.6.8. Querying the HDCP State

The current state of the HDCP encryption can be queried at the input port; see the [RS-232 Signal Management \(VINX AP-Series\)](#) section.

Command and Response *#hdc*

- ▶ GET•/MEDIA/VIDEO/<in>.HdcpState
- ◀ pr•/MEDIA/VIDEO/<in>.HdcpState=<HDCP_state>

Parameters

If the <HDCP_state> parameter is **0**, then the HDCP encryption is disabled at the port. If the value is **1**, then HDCP encryption is enabled.

Example

- ▶ GET /MEDIA/VIDEO/I1.HdcpState
- ◀ pr /MEDIA/VIDEO/I1.HdcpState=1

6.6.9. Setting the HDCP State

HDCP capability can be enabled/disabled on the input port of the Encoder, thus, non-encrypted content can be seen on a non-HDCP compliant display if the content allows it; see the [RS-232 Signal Management \(VINX AP-Series\)](#) section.

Command and Response

- ▶ SET•/MEDIA/VIDEO/<in>.HdcpEnable=<HDCP_state>
- ◀ pw•/MEDIA/VIDEO/<in>.HdcpEnable=<HDCP_state>

ATTENTION! When you change this property the `applySettings` method must be called always to store the new setting. If the HDCP State is changed the device is restarted automatically.

Parameters

See the previous section.

Example

- ▶ SET /MEDIA/VIDEO/I1.HdcpEnable=0
- ◀ pw /MEDIA/VIDEO/I1.HdcpEnable=false
- ▶ CALL /MEDIA/VIDEO/I1:applySettings()
- ◀ mO /MEDIA/VIDEO/I1:applySettings

ATTENTION! The EDID information cannot be read by the source attached to the HDMI input of an Encoder if HDCP is disabled on the input. That may stop the video transmission in the case of certain source devices.

6.7. Decoder-related Commands

6.7.1. Querying the Resolution of the Output Video Signal

The resolution and the refresh rate of the outgoing video signal can be queried.

Command and Response *#resolution*

- ▶ GET•/MEDIA/VIDEO/<out>.Resolution
- ◀ pr•/MEDIA/VIDEO/<out>.Resolution=<resolution@refresh_rate>

Example

- ▶ GET /MEDIA/VIDEO/O1.Resolution
- ◀ pr /MEDIA/VIDEO/O1.Resolution=1600x1200@60Hz

6.7.2. Querying the Scaling Mode of the Output Video Signal

Command and Response *#scaler*

- ▶ GET•/MEDIA/VIDEO/<out>/SCALER.ScalingMode
- ◀ pw•/MEDIA/VIDEO/<out>/SCALER.ScalingMode=<sc_mode>

Parameters

Identifier	Parameter description	Parameter values
<sc_mode>	Scaling mode	OFF: Scaling is disabled, the resolution is not changed. EDID: the resolution is set to meet with the preferred timing of the sink device. MANUAL: Scaling is set manually.

Example

- ▶ GET /MEDIA/VIDEO/O1/SCALER.ScalingMode
- ◀ pw /MEDIA/VIDEO/O1/SCALER.ScalingMode=MANUAL

See more information about the scaling modes in the [Main Settings \(Decoder\)](#) section.

6.7.3. Setting the Scaling Mode of the Output Video Signal

Command and Response

- ▶ SET•/MEDIA/VIDEO/<out>/SCALER.ScalingMode=<sc_mode>
- ◀ pw•/MEDIA/VIDEO/<out>/SCALER.ScalingMode=<sc_mode>

Parameters

See the previous section.

Example

- ▶ SET /MEDIA/VIDEO/O1/SCALER.ScalingMode=OFF
- ◀ pw /MEDIA/VIDEO/O1/SCALER.ScalingMode=OFF

See more information about the scaling modes in the [Main Settings \(Decoder\)](#) section.

6.7.4. Setting the Resolution of the Output Video Signal

The resolution and the refresh rate of the outgoing video signal can be set.

Command and Response

- ▶ SET•/MEDIA/VIDEO/<out>/SCALER.OutputResolution
- ◀ pw•/MEDIA/VIDEO/<out>/SCALER.OutputResolution=<Resolution_code>

Parameters

The <Resolution_code> is an 8-character long code covering the scaled resolution and refresh rate. The complete list can be found in the [Output Resolutions \(Scaler\)](#) section.

Example

- ▶ SET /MEDIA/VIDEO/O1/SCALER.OutputResolution=81004088
- ◀ pw /MEDIA/VIDEO/O1/SCALER.OutputResolution=81004088

Explanation

The new value of the parameter is 81004088 which means the resolution of the output signal is set to 1280x720@60Hz.

ATTENTION! Set the **ScalingMode** property to **MANUAL** after changing the **Resolution** property manually to apply the new settings.

6.7.5. Querying the Signal Type of the Output Video Signal

Command and Response *#signaltype*

- ▶ GET•/MEDIA/VIDEO/<out>/SCALER.SignalType
- ◀ pw•/MEDIA/VIDEO/<out>/SCALER.SignalType=<sig_type>

Parameters

The <sig_type> can be **DVI** or **HDMI**.

Example

- ▶ GET /MEDIA/VIDEO/O1/SCALER.SignalType
- ◀ pw /MEDIA/VIDEO/O1/SCALER.SignalType=HDMI

6.7.6. Setting the Signal Type of the Output Video Signal

Command and Response

- ▶ SET•/MEDIA/VIDEO/<out>/SCALER.SignalType=<sig_type>
- ◀ pw•/MEDIA/VIDEO/<out>/SCALER.SignalType=<sig_type>

Parameters

See the previous section.

Example

- ▶ SET /MEDIA/VIDEO/O1/SCALER.SignalType=HDMI
 - ◀ pw /MEDIA/VIDEO/O1/SCALER.SignalType=HDMI
- INFO: The property takes effect only when the **ScalingMode** property is set to **MANUAL** setting.

6.7.7. Querying the State of the USB Connection

When the extenders are in **Multicast mode** the USB transmission has to be determined by selecting the active Decoder. To query the current state of a given Decoder use the following command:

Command and Response *#usbkvm #kvm*

- ▶ GET•/MEDIA/KM.Controlling
- ◀ pr•/MEDIA/KM.Controlling=<USB_state>

Parameters

If the <USB_state> parameter is **0** (or **false**) there is no USB data transmission to/from an Encoder. If the value is **1** (or **true**) the USB data transmission is enabled and the Decoder is connected to an Encoder.

Example

- ▶ GET /MEDIA/KM.Controlling
- ◀ pr /MEDIA/KM.Controlling=false

See more information about the USB features in the [Analog Audio Interface](#) section.

6.7.8. Establishing the USB Connection

When the extenders are in **Multicast mode** the USB transmission has to be determined by selecting the active Decoder. To establish the connection between the Decoder and the Encoder use the following command:

Command and Response

- ▶ CALL•/MEDIA/KM:acquireControl(true)
- ◀ mO•/MEDIA/KM:acquireControl

Example

- ▶ CALL /MEDIA/KM:acquireControl(1)
- ◀ mO /MEDIA/KM:acquireControl

■ **ATTENTION!** Establishing the connection to a Decoder will disconnect the USB transmission of the previously connected Decoder.

6.8. Audio-related Commands

DIFFERENCE: The following commands refer to the AP-series only.

The port numbering is a required parameter in most cases. See the details in the [Audio Port Numbering](#) section. *#audio*

6.8.1. Querying the Audio Input Selection Mode

Command and Response

- ▶ GET*/MEDIA/AUDIO.ioSelect
- ◀ pw*/MEDIA/AUDIO.ioSelect=<sel_mode>

Parameters

Identifier	Parameter description	Parameter values
<sel_mode>	The currently applied audio input selection method.	0: unknown 1: HDMI 2: analog 3: auto1 4: auto2

- **auto1:** the analog audio input port is selected when a plug is connected.
- **auto2:** the selection follows the video input setting:
 - When HDMI is selected as the video source, the audio of the original HDMI stream is transmitted.
 - When VGA is selected as the video source, the analog audio is transmitted.

INFO: **auto2** mode is available in VINX-210AP-HDMI-ENC device only.

Example

- ▶ GET /MEDIA/AUDIO.ioSelect
- ◀ pw /MEDIA/AUDIO.ioSelect=1

6.8.2. Setting the Audio Input Selection Mode

Command and Response

- ▶ SET*/MEDIA/AUDIO.ioSelect=<sel_mode>
- ◀ pw*/MEDIA/AUDIO.ioSelect=<sel_mode>

Parameters

See the previous section.

Example

- ▶ SET /MEDIA/AUDIO.ioSelect
- ◀ pw /MEDIA/AUDIO.ioSelect=2

6.8.3. Querying the Audio Signal Presence

Command and Response

- ▶ GET*/MEDIA/AUDIO/<in>.SignalPresent
- ◀ pr*/MEDIA/AUDIO/<in>.SignalPresent=<signal_present>

Parameters

If the <signal_present> parameter is **0** or **false**, then signal is not present at the port. If the value is **1** or **true**, then signal is present at the input.

INFO: In the case of analog audio ports the value of the parameter is 1 when a plug is connected.

Example

- ▶ GET /MEDIA/AUDIO/I1.SignalPresent
- ◀ pr /MEDIA/AUDIO/I1.SignalPresent=false

6.8.4. Analog Audio Input/Output Signal Level Settings

6.8.4.1. Querying the Volume (Exact Value)

Command and Response *#analogaudio #volume*

- ▶ GET*/MEDIA/AUDIO/<port>.AnalogVolumedB
- ◀ pw*/MEDIA/AUDIO/<port>.AnalogVolumedB=<value>

Parameters

The response <value> is in dB.

Example

- ▶ GET /MEDIA/AUDIO/I2.AnalogVolumedB
- ◀ pw /MEDIA/AUDIO/I2.AnalogVolumedB=-20.00

6.8.4.2. Setting the Volume (Exact Value)

Command and Response

- ▶ SET*/MEDIA/AUDIO/<port>.AnalogVolumedB=<value>
- ◀ pw*/MEDIA/AUDIO/<port>.AnalogVolumedB=<value>

Parameters

The <value> is in dB and the accepted values are between -44 and 0.

Example

- ▶ SET /MEDIA/AUDIO/I2.AnalogVolumedB=-10
- ◀ pw /MEDIA/AUDIO/I2.AnalogVolumedB=-10.00

INFO: Changing the value of above property will also change the **AnalogVolume** property accordingly.

6.8.4.3. Setting the Volume (by a Step Value)

Command and Response

- ▶ CALL•/MEDIA/AUDIO/<port>:stepVolumeDb(<value>)
- ◀ mO•/MEDIA/AUDIO/<port>:stepVolumeDb

Parameters

The <value> is in dB; positive and negative values are accepted.

Example

- ▶ CALL /MEDIA/AUDIO/I2:stepVolumeDb(-10.5)
- ◀ mO /MEDIA/AUDIO/I2:stepVolumeDb

Explanation

The volume of the audio signal has been decreased by 10.5 dB.

■ INFO: Calling above method will change the **AnalogVolume** and **AnalogVolumedB** properties accordingly.

6.8.4.4. Querying the Volume (in Percentage)

Command and Response

- ▶ GET•/MEDIA/AUDIO/<port>.AnalogVolume
- ◀ pw•/MEDIA/AUDIO/<port>.AnalogVolume=<vol_per>

Parameters

The value of <vol_per> is defined between 0 and 100 (min and max).

Example

- ▶ GET /MEDIA/AUDIO/I2.AnalogVolume
- ◀ pw /MEDIA/AUDIO/I2.AnalogVolume=80

6.8.4.5. Setting the Volume (in Percentage)

Command and Response

- ▶ SET•/MEDIA/AUDIO/<port>.AnalogVolume=<value>
- ◀ pw•/MEDIA/AUDIO/<port>.AnalogVolume=<value>

Parameters

The <value> is defined in percentage. The accepted values are between 0 and 100. Higher/lower values will be rounded up/down.

Example

- ▶ SET /MEDIA/AUDIO/I2.AnalogVolume=50
- ◀ pw /MEDIA/AUDIO/I2.AnalogVolume=50

■ INFO: Changing the value of above property will also change the **AnalogVolumedB** property accordingly.

6.8.4.6. Setting the Volume (by a Step Value in Percentage)

Command and Response

- ▶ CALL•/MEDIA/AUDIO/<port>:stepVolumePercent(<value>)
- ◀ mO•/MEDIA/AUDIO/<port>:stepVolumePercent

Parameters

The <value> is defined in percentage. The accepted values are between 0 and 100. Higher/lower values will be rounded up/down. Please note that the step value is calculated from 100% – see the example below:

Example

- ▶ GET /MEDIA/AUDIO/I2.AnalogVolume
- ◀ pw /MEDIA/AUDIO/I2.AnalogVolume=80
- ▶ CALL /MEDIA/AUDIO/<port>:stepVolumePercent=-10
- ◀ mO /MEDIA/AUDIO/<port>:stepVolumePercent
- ◀ CHG /MEDIA/AUDIO/O2.AnalogVolume=70

■ INFO: Changing the value of above property will also change the **AnalogVolumedB** property accordingly.

6.8.4.7. Querying the Mute State

Command and Response #mute #unmute

- ▶ GET•/MEDIA/AUDIO/<port>.AnalogMute
- ◀ pw•/MEDIA/AUDIO/<port>.AnalogMute=<mute_state>

Parameters

If the <mute_state> parameter is **0** or **false**, then the port is **not muted**. If the value is **1** or **true**, port is **muted**.

Example

- ▶ GET /MEDIA/AUDIO/I2.AnalogMute
- ◀ pw /MEDIA/AUDIO/I2.AnalogMute=false

6.8.4.8. Setting the Mute State

Command and Response

- ▶ GET•/MEDIA/AUDIO/<port>.AnalogMute
- ◀ pw•/MEDIA/AUDIO/<port>.AnalogMute=<mute_state>

Parameters

See the previous section.

■ INFO: Changing the value of above property to **0** or **false** will also change the **AnalogVolume** and **AnalogVolumedB** properties accordingly.

Example

- ▶ SET /MEDIA/AUDIO/I2.AnalogVolume=50
- ◀ pw /MEDIA/AUDIO/I2.AnalogVolume=50

6.9. Serial Port Settings

ATTENTION! The new port settings are stored but applied only if the `applySettings` method is called which will reboot the device. When two or more serial parameters are changed the `applySettings` method is enough to call once as a final step; it results the extender to reboot.

INFO: Below listed commands can be used to set the RS-232 port parameters. To query the current value of a parameter use the GET command, e.g.: `GET /MEDIA/UART/P1.BaudRate`.

6.9.1. Setting the Port Availability

ATTENTION! The port must be enabled for the RS-232 data transmission; use this command.

Command and Response *#rs232 #rs-232 #serial*

- ▶ `SET•/MEDIA/UART/<port>.Enabled=<port_status>`
- ◀ `pw•/MEDIA/UART/<port>.Enabled=<port_status>`

Parameters

If the `<port_status>` parameter is **0** (or **false**) there is no RS-232 data transmission to/from another device. If the value is **1** (or **true**) the RS-232 data transmission is enabled.

Example

- ▶ `SET /MEDIA/UART/P1.Enabled=true`
- ◀ `pw /MEDIA/UART/P1.Enabled=true`
- ▶ `CALL /MEDIA/UART/P1:applySettings(1)`
- ◀ `mO /MEDIA/UART/P1:applySettings`

INFO: The `applySettings` method will save and apply the new value and makes the extender reboot.

6.9.2. Setting the Baud Rate of the Port

Command and Response

- ▶ `SET•/MEDIA/UART/<port>.Baudrate=<Baud_value>`
- ◀ `pw•/MEDIA/UART/<port>.Baudrate=<Baud_value>`

Parameters

The `<Baud_value>` parameter can be set to: 300, 600, 1200, 2400, 4800, 9600, 19200, 38400, 57600, 115200.

Example

- ▶ `SET /MEDIA/UART/P1.Baudrate=57600`
- ◀ `pw /MEDIA/UART/P1.Baudrate=57600`
- ▶ `CALL /MEDIA/UART/P1:applySettings(1)`
- ◀ `mO /MEDIA/UART/P1:applySettings`

INFO: The `applySettings` method will save and apply the new value and makes the extender reboot.

6.9.3. Setting the RS-232 Port Mode

The RS-232 port can be set to **Pass-through** or **Command Injection** mode. The introduction of these modes can be found in the [Dante® Audio Output Interface](#) section.

Command and Response

- ▶ `SET•/MEDIA/UART/<port>.Guest=<port_mode>`
- ◀ `pw•/MEDIA/UART/<port>.Guest=<port_mode>`

Parameters

If the `<port_mode>` parameter is **0** (or **false**) the mode is **Pass-through**. If the value is **1** (or **true**) the port is in **Command injection** mode; in that case, use the **6752** TCP/IP port number to address the port.

Example

- ▶ `SET /MEDIA/UART/P1.Guest=false`
- ◀ `pw /MEDIA/UART/P1.Guest=false`
- ▶ `CALL /MEDIA/UART/P1:applySettings(1)`
- ◀ `mO /MEDIA/UART/P1:applySettings`

INFO: The `applySettings` method will save and apply the new value and makes the extender reboot.

6.9.4. Setting the Data Bits

Command and Response

- ▶ `SET•/MEDIA/UART/<port>.DataBits=<Databits_value>`
- ◀ `pw•/MEDIA/UART/<port>.DataBits=<Databits_value>`

Parameters

The `<Databits_value>` parameter can be set to the following values: 6, 7, 8

Example

- ▶ `SET /MEDIA/UART/P1.DataBits=8`
- ◀ `pw /MEDIA/UART/P1.DataBits=8`
- ▶ `CALL /MEDIA/UART/P1:applySettings(1)`
- ◀ `mO /MEDIA/UART/P1:applySettings`

INFO: The `applySettings` method will save and apply the new value and makes the extender reboot.

6.9.5. Setting the Stop Bits

Command and Response

- ▶ SET•/MEDIA/UART/<port>.StopBits=<Stopbits_value>
- ◀ pw•/MEDIA/UART/<port>.StopBits=<Stopbits_value>

Parameters

The <Stopbits_value> parameter can be set to the following values: 1, 2.

Example

- ▶ SET /MEDIA/UART/P1.StopBits=1
- ◀ pw /MEDIA/UART/P1.StopBits=1
- ▶ CALL /MEDIA/UART/P1:applySettings(1)
- ◀ mO /MEDIA/UART/P1:applySettings

INFO: The **applySettings** method will save and apply the new value and makes the extender reboot.

6.9.6. Setting the Parity

Command and Response

- ▶ SET•/MEDIA/UART/<port>.Parity=<parity_setting>
- ◀ pw•/MEDIA/UART/<port>.Parity=<parity_setting>

Parameters

Identifier	Parameter description	Parameter values
<parity_setting>	Parity (error detection method)	n: none o: odd e: even

Example

- ▶ SET /MEDIA/UART/P1.Parity=n
- ◀ pw /MEDIA/UART/P1.Parity=n
- ▶ CALL /MEDIA/UART/P1:applySettings(1)
- ◀ mO /MEDIA/UART/P1:applySettings

INFO: The **applySettings** method will save and apply the new value and makes the extender reboot.

6.10. Arranging the Extenders to Groups

6.10.1. Querying the Working Mode (Unicast/Multicast)

Command and Response #unicast #multicast

- ▶ GET•/MANAGEMENT/MULTICAST.MulticastMode
- ◀ pw•/MANAGEMENT/MULTICAST.MulticastMode=<Multicast_mode>

Parameters

If the <Multicast_mode> parameter is **0** (or **false**) the device is in **Unicast mode**. If the property value is **1** (or **true**) the device is in **Multicast mode**.

Example

- ▶ GET /MANAGEMENT/MULTICAST.MulticastMode
- ◀ pw /MANAGEMENT/MULTICAST.MulticastMode=false

6.10.2. Setting the Working Mode (Unicast/Multicast)

Command and Response

- ▶ SET•/MANAGEMENT/MULTICAST.MulticastMode=<Multicast_mode>
- ◀ pw•/MANAGEMENT/MULTICAST.MulticastMode=<Multicast_mode>

Parameters

See the previous section.

Example

- ▶ SET /MANAGEMENT/MULTICAST.MulticastMode=1
- ◀ pw /MANAGEMENT/MULTICAST.MulticastMode=true
- ▶ CALL /MANAGEMENT/MULTICAST:applySettings(1)

ATTENTION! When you change the working mode the **applySettings** method must be called always to store the new settings. After that, the device is restarted automatically; response is not sent.

6.10.3. Querying the Video Stream ID Setting Method

The Video stream ID can be set by the front panel DIP switch or by software.

Command and Response *#videostreamid #streamid*

- ▶ GET•/SYS/MB/PHY.ChannelIdSetBySoftware
- ◀ pr•/SYS/MB/PHY.ChannelIdSetBySoftware=<sw_setting>

Parameters

If the <sw_setting> parameter is **0** (or **false**) the Video Stream ID is set by the front panel DIP switch (HW setting). If the property value is **1** (or **true**) the Video Stream ID can be set by the command described in the [Setting the Video Stream ID](#) section (SW setting).

Example

- ▶ GET /SYS/MB/PHY.ChannelIdSetBySoftware
- ◀ pr /SYS/MB/PHY.ChannelIdSetBySoftware=false

Explanation

The current Video Stream ID is HW setting, the front panel DIP switch is valid. The ID can be changed only by the DIP switch.

ATTENTION! The state of the DIP switch can be ignored, see the [DIP Switch Enable](#) section.

6.10.4. Querying the DIP Switch Value

The current value of the DIP switch can be queried as follows:

Command and Response *#dipswitch*

- ▶ GET•/SYS/MB/GPIO.DipSwitch
- ◀ pr•/SYS/MB/GPIO.DipSwitch=<DIP_value>

Parameters

The states/values of the <DIP_value> parameter are described in the [Firmware Release Notes](#) section.

Example

- ▶ GET /SYS/MB/GPIO.DipSwitch
- ◀ pr /SYS/MB/GPIO.DipSwitch=0x8

Explanation

The current value is 0x8: the switch is in '1000' state, the Video Stream ID is '8'.

6.10.5. Querying the Video Stream ID

The response of the below command contains the current Video Stream ID, but contains no information about the setting method (HW setting/SW setting).

Command and Response

- ▶ GET•/SYS/MB/PHY.VideoChannelId
- ◀ pw•/SYS/MB/PHY.VideoChannelId=<channel_ID>

Parameter

The value of the <channel_ID> can be between 1 and 255.

Example

- ▶ GET /SYS/MB/PHY.VideoChannelId
- ◀ pw /SYS/MB/PHY.VideoChannelId=10

6.10.6. DIP Switch Enable

The front panel DIP switch can be ignored by the below command. The command can be used to avoid an accidental Video stream ID change caused by a front panel switching.

Command and Response

- ▶ SET•/SYS/MB/GPIO.DipSwitchEnable=<switch_valid>
- ◀ pw•/SYS/MB/GPIO.DipSwitchEnable=<switch_valid>

Parameters

If the <switch_valid> parameter is **0** (or **false**) the DIP switch change has no effect on the Video Stream ID. If the property value is **1** (or **true**) the DIP switch has an effect on the ID (when it is in a state other than '0000').

Example

- ▶ SET /SYS/MB/GPIO.DipSwitchEnable=false
- ◀ pw /SYS/MB/GPIO.DipSwitchEnable=false

6.10.7. Setting the Video Stream ID

If the front panel DIP switch is in '0000' state or the DIP switch state is ignored, the Video Stream ID can be set by the following command:

Command and Response

- ▶ SET•/SYS/MB/PHY.VideoChannelId=<channel_ID>
- ◀ pw•/SYS/MB/PHY.VideoChannelId=<channel_ID>

Parameter

The value of the <channel_ID> can be between 1 and 255.

Example

- ▶ SET /SYS/MB/PHY.VideoChannelId=8
- ◀ pw /SYS/MB/PHY.VideoChannelId=8

6.11. Video Wall Settings

Basic Rules *#videowall*

- One Decoder can be a part of only one video wall.
- The video wall must have a unique name within a system; the length of the name shall not exceed 24 characters.
- The video walls are stored in the LW3 protocol tree of the Decoders.
- All the Decoders and the Encoder must be set one-by-one. The set parameters are applied only in the given device.

Short Instructions

- Step 1.** All the affected VINX devices must be in Multicast mode. See the [Setting the Working Mode \(Unicast/Multicast\)](#) section to set the mode if necessary.
- Step 2.** Set the same Video Stream ID in the Encoder and in all desired Decoders. Use the front panel DIP switch and/or the commands as described in the [Setting the Video Stream ID](#) section.
- Step 3.** Send the Video Wall setup command to each Decoder one-by-one as described in the [Assigning a Decoder to a Video Wall](#) section.

6.11.1. Setting the Name of the Video Wall

Set the name of the video wall in the Decoder devices as follows:

Command and Response

- ▶ SET•/MEDIA/VIDEO/O1/VIDEOWALL.Name=<wall_name>
- ◀ pw•/MEDIA/VIDEO/O1/VIDEOWALL.Name=<wall_name>

Parameters

The video wall must have a unique name (<wall_name>) within a system ; the length of the name shall not exceed 24 characters.

Example

- ▶ SET /MEDIA/VIDEO/O1/VIDEOWALL.Name=Office_2x2
- ◀ pw /MEDIA/VIDEO/O1/VIDEOWALL.Name=Office_2x2

6.11.2. Assigning a Decoder to a Video Wall

ATTENTION! Setting the name of the video wall is highly recommended (see the previous section).

Command and Response

- ▶ SET•/MEDIA/VIDEO/O1/VIDEOWALL.Layout=<wall_parameters>
- ◀ pw•/MEDIA/VIDEO/O1/VIDEOWALL.Layout=<wall_parameters>

Parameters

The <wall_parameters> include the following order of settings:

<tot_col>;<tot_row>;<col_pos>;<row_pos>;<wid>;<hei>;<Hgap>;<Vgap>;<Btop>;<Bbot>;<Blef>;<Brig>;

Identifier	Parameter description
<tot_col>	Total number of columns
<tot_row>	Total number of rows
<col_pos>	Column position of the Decoder
<row_pos>	Row position of the Decoder
<wid>	The width of the screen (display area) (mm)
<hei>	The height of the screen (display area) (mm)
<Hgap>	Horizontal gap between the sinks (mm)
<Vgap>	Vertical gap between the sinks (mm)
<Btop>	Top bezel of the given sink (mm)
<Bbot>	Bottom bezel of the given sink (mm)
<Blef>	Left bezel of the given sink (mm)
<Brig>	Right bezel of the given sink (mm)

Example

- ▶ SET /MEDIA/VIDEO/O1/VIDEOWALL.Layout=2;2;1;1;520;320;0;0;0;0;0;0;
- ◀ pw /MEDIA/VIDEO/O1/VIDEOWALL.Layout=2;2;1;1;520;320;0;0;0;0;0;0;

Explanation

2x2 sized video wall is defined, the current Decoder is positioned in the first column, in the first row. The size of a display device is 520x320 mm. No bezel and gap are set.

INFO: If the Bezel and Gap values are zero the dimensions (width and height) do not matter.

6.12. Setting up a Video Wall (Example)

The following list of commands show how a video wall can be created by sending LW3 commands. The specifications are the following:

- **Name:** Office_2x2
- **Size:** 2x2
- **Video Stream ID:** 10
- **IP address:** Encoder: 192.168.0.80, Decoders: see the figure
- **Display width:** 520x320 mm (each display)
- **Gap:** 20 mm
- **Bezel:** 10 mm (at all sides)

A1	B1
192.168.0.81	192.168.0.82
A2	B2
192.168.0.83	192.168.0.84

INFO: The IP address of each device has been set previously and the DIP switch is in **0000** position.

Commands Sent to the Encoder

- ▶ SET /MANAGEMENT/MULTICAST.MulticastMode=true
- ◀ pw /MANAGEMENT/MULTICAST.MulticastMode=true
- ▶ SET /SYS/MB/PHY.VideoChannelId=10
- ◀ pw /SYS/MB/PHY.VideoChannelId=10

Commands Sent to the Decoder (A1)

- ▶ SET /MANAGEMENT/MULTICAST.MulticastMode=true
- ◀ pw /MANAGEMENT/MULTICAST.MulticastMode=true
- ▶ SET /SYS/MB/PHY.VideoChannelId=10
- ◀ pw /SYS/MB/PHY.VideoChannelId=10
- ▶ SET /MEDIA/VIDEO/O1/VIDEOWALL.Layout=2;2;1;1;520;320;20;20;0;10;0;10;
- ◀ pw /MEDIA/VIDEO/O1/VIDEOWALL.Layout=2;2;1;1;520;320;20;20;0;10;0;10;
- ▶ SET /MEDIA/VIDEO/O1/VIDEOWALL.Name=Office_2x2
- ◀ pw /MEDIA/VIDEO/O1/VIDEOWALL.Name=Office_2x2

Commands Sent to the Decoder (B1)

- ▶ SET /MANAGEMENT/MULTICAST.MulticastMode=true
- ◀ pw /MANAGEMENT/MULTICAST.MulticastMode=true
- ▶ SET /SYS/MB/PHY.VideoChannelId=10
- ◀ pw /SYS/MB/PHY.VideoChannelId=10
- ▶ SET /MEDIA/VIDEO/O1/VIDEOWALL.Layout=2;2;2;1;520;320;20;20;0;10;10;0;
- ◀ pw /MEDIA/VIDEO/O1/VIDEOWALL.Layout=2;2;2;1;520;320;20;20;0;10;10;0;
- ▶ SET /MEDIA/VIDEO/O1/VIDEOWALL.Name=Office_2x2
- ◀ pw /MEDIA/VIDEO/O1/VIDEOWALL.Name=Office_2x2

Commands Sent to the Decoder (A2)

- ▶ SET /MANAGEMENT/MULTICAST.MulticastMode=true
- ◀ pw /MANAGEMENT/MULTICAST.MulticastMode=true
- ▶ SET /SYS/MB/PHY.VideoChannelId=10
- ◀ pw /SYS/MB/PHY.VideoChannelId=10
- ▶ SET /MEDIA/VIDEO/O1/VIDEOWALL.Layout=2;2;1;2;520;320;20;20;10;0;0;10;
- ◀ pw /MEDIA/VIDEO/O1/VIDEOWALL.Layout=2;2;1;2;520;320;20;20;10;0;0;10;
- ▶ SET /MEDIA/VIDEO/O1/VIDEOWALL.Name=Office_2x2
- ◀ pw /MEDIA/VIDEO/O1/VIDEOWALL.Name=Office_2x2

Commands Sent to the Decoder (B2)

- ▶ SET /MANAGEMENT/MULTICAST.MulticastMode=true
- ◀ pw /MANAGEMENT/MULTICAST.MulticastMode=true
- ▶ SET /SYS/MB/PHY.VideoChannelId=10
- ◀ pw /SYS/MB/PHY.VideoChannelId=10
- ▶ SET /MEDIA/VIDEO/O1/VIDEOWALL.Layout=2;2;2;2;520;320;20;20;10;0;10;0;
- ◀ pw /MEDIA/VIDEO/O1/VIDEOWALL.Layout=2;2;2;2;520;320;20;20;10;0;10;0;
- ▶ SET /MEDIA/VIDEO/O1/VIDEOWALL.Name=Office_2x2
- ◀ pw /MEDIA/VIDEO/O1/VIDEOWALL.Name=Office_2x2

6.13. Crosspoint Switching Examples

The VINX devices can be arranged and used as a matrix. The working method of such a system is different than a dedicated matrix switcher. Therefore, the approach and the control commands are also different.

Important Notices about System Usage *#switch #crosspoint*

- The switching is realized in practice by **setting the Video stream ID** of the given **Decoder** to the same ID as the desired **Encoder**.
- The commands are addressed to **each Decoder separately** via LAN.
- The **crosspoint state cannot be queried** by a global command.
- **TX** means the **Encoder**, **RX** means the **Decoder** in the drawings.

The following example demonstrates a 4x4 matrix layout and crosspoint-related commands how they can be used for crosspoint-handling. The initial state in the example is **diagonal**: I1-O1; I2-O2; I3-O3; I4-O4.

6.13.1. Switching an Input to an Output

- ▶ `SET /SYS/MB/PHY.VideoChannelId=2`
- ◀ `pw /SYS/MB/PHY.VideoChannelId=2`

Above command is sent to the **RX1 Decoder**.

6.13.2. Switching an Input to All Outputs

- ▶ `SET /SYS/MB/PHY.VideoChannelId=2`
- ◀ `pw /SYS/MB/PHY.VideoChannelId=2`

Above command is sent to **all Decoders** separately.

6.13.3. Switching the Source of a Video Wall

The source **Encoder** of an existing video wall (**VW1**) can be changed. In this case, the Video stream ID of the affected **Decoders** must be changed one-by-one.

- ▶ `SET /SYS/MB/PHY.VideoChannelId=4`
- ◀ `pw /SYS/MB/PHY.VideoChannelId=4`

Above command is sent to **all Decoders** in the **Video wall**.

INFO: The video wall properties are not changed by switching the **Encoder**. Each **Decoder** will show **the same area** of the (new) image as it had been set previously.

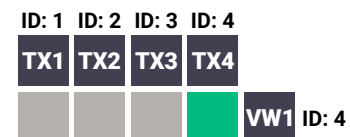
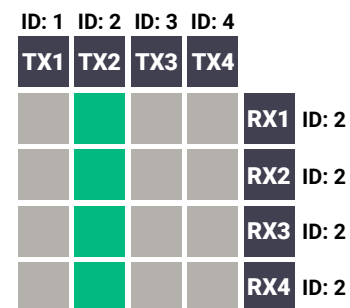
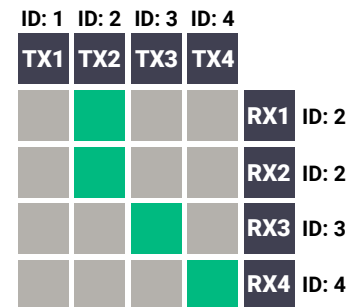
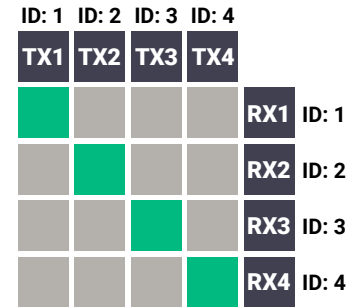

6.13.4. Multiple Switching

The commands have to be sent to the **Decoders** one-by-one thus, the switching is realized in practice by **setting the Video stream ID** of the **Decoders** to the same ID as the desired **Encoders**.

- ▶ `SET /SYS/MB/PHY.VideoChannelId=4`
- ◀ `pw /SYS/MB/PHY.VideoChannelId=4`

Above command is sent to **RX1**.

- ▶ `SET /SYS/MB/PHY.VideoChannelId=3`
- ◀ `pw /SYS/MB/PHY.VideoChannelId=3`

Above command is sent to **RX2**.

- ▶ `SET /SYS/MB/PHY.VideoChannelId=2`
- ◀ `pw /SYS/MB/PHY.VideoChannelId=2`

Above command is sent to **RX3**.

- ▶ `SET /SYS/MB/PHY.VideoChannelId=1`
- ◀ `pw /SYS/MB/PHY.VideoChannelId=1`

Above command is sent to **RX4**.

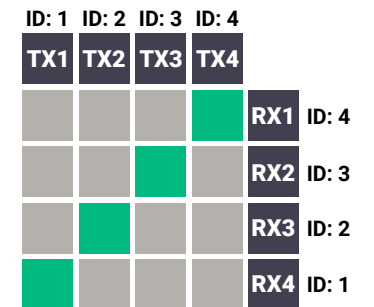

6.14. EDID Management (Encoder)

The Advanced EDID Management is available also by sending LW3 protocol commands. The structure of the EDID memory can be found in the [EDID Menu](#) section.

6.14.1. Querying the Emulated EDID

Command and Response *#edid*

- ▶ GET•/EDID.EdidStatus
- ◀ pr•/EDID.EdidStatus=<EDID_mem_loc>:E1

Parameters

Identifier	Parameter description	Parameter values
<EDID_mem_loc>	The EDID memory location	F1-F132: Factory preset EDIDs U1-U5: User presets D1: The EDID of the Display Device at the local output

E1 means the Emulated EDID memory location (Input port).

INFO: There are empty slots in the Factory EDID range for future developments. See the [Factory EDID List](#) section.

Example

- ▶ GET /EDID.EdidStatus
- ◀ pr /EDID.EdidStatus=F47:E1

Explanation

F47 EDID (Factory #47) is currently emulated on the input port of the Encoder (E1).

6.14.2. Setting the Emulated EDID on the Input Port

Command and Response

- ▶ CALL•/EDID:switch(<source>:<destination>)
- ◀ mO•/EDID:switch

Parameters

Identifier	Parameter description	Parameter values
<source>	Source EDID memory location	F1-F132: Factory preset EDIDs U1-U5: User presets D1: The EDID of the Display Device at the local output
<destination>	The emulated EDID memory of the input port	E1

Example

- ▶ CALL /EDID:switch(F49:E2)
- ◀ mO /EDID:switch

6.14.3. Copying an EDID

Command and Response

- ▶ CALL•/EDID:copy(<source>:<destination>)
- ◀ mO•/EDID:copy

Parameters

Identifier	Parameter description	Parameter values
<source>	Source EDID memory location	F1-F132: Factory preset EDIDs U1-U5: User presets D1: The EDID of the Display Device at the local output
<destination>	The desired User EDID location	U1-U5

Example

- ▶ CALL /EDID:copy(D1:U1)
- ◀ mO /EDID:copy

Explanation

The EDID of the last connected sink (HDMI output, D1) has been copied to U1 User memory slot.

6.14.4. Querying the Preferred Resolution of an EDID

Command and Response

- ▶ GET•/EDID/<EDID_mem>/<EDID_mem_loc>.PreferredResolution
- ◀ pr•/EDID/<EDID_mem>/<EDID_mem_loc>.PreferredResolution=<Resolution>

Parameters

Identifier	Parameter description	Parameter values
<EDID_mem>	The desired EDID memory type	F: Factory preset EDIDs U: User presets D: EDID from a connected display device E: Emulated EDID
<EDID_mem_loc>	The desired EDID memory location	F1-F132: Factory preset EDIDs U1-U5: User presets D1: The EDID of the Display Device at the local output E1: The emulated EDID at the input
<Resolution>	The preferred resolution in the indicated format	<width>x<height><scan_mode><refresh_rate>Hz <scan_mode>: p (progressive), i (interlaced)

Example

- ▶ GET /EDID/U/U2.PreferredResolution
- ◀ pr /EDID/U/U2.PreferredResolution=1920x1080p60.00Hz

INFO: Use the **Manufacturer** property to query the manufacturer and the **MonitorName** property to query the name of the monitor.

6.14.5. Deleting an EDID from the User Memory

Command and Response

- ▶ CALL•/EDID:delete(<User_loc>)
- ◀ mO•/EDID:delete

Parameters

Identifier	Parameter description	Parameter values
<User_loc>	User EDID location	U1-U5

Example

- ▶ CALL /EDID:delete(U1)
- ◀ mO /EDID:delete

6.15. LW3 Commands - Quick Summary

System Commands

Querying the Product Name

- ▶ GET•/.ProductName

Setting the Device Label

- ▶ SET•/SYS/MB.DeviceLabel=<Custom_name>

Querying the Serial Number

- ▶ GET•/.SerialNumber

Querying the Package Version

- ▶ GET•/SYS/MB.PackageVersion

Resetting the Device

- ▶ CALL•/SYS:reset()

Restoring the Factory Default Settings

- ▶ CALL•/SYS:factoryDefaults()

Network Configuration

Querying the IP Address

- ▶ GET•/MANAGEMENT/NETWORK.IpAddress

Querying the IP Setup Mode (FW 2.x.x)

- ▶ GET•/MANAGEMENT/NETWORK.IpSetupMode

Setting the IP Setup Mode (FW 2.x.x)

- ▶ SET•/MANAGEMENT/NETWORK.IpSetupMode

Querying the DHCP State (FW 1.x.x)

- ▶ GET•/MANAGEMENT/NETWORK.DhcpEnabled

Setting the DHCP State (FW 1.x.x)

- ▶ SET•/MANAGEMENT/NETWORK.DhcpEnabled=<DHCP_state>

Setting a Static IP Address

- ▶ SET•/MANAGEMENT/NETWORK.StaticIpAddress=<IP_address>

Querying the Subnet Mask

- ▶ GET•/MANAGEMENT/NETWORK.NetworkMask

Setting a Static Subnet Mask

- ▶ SET•/MANAGEMENT/NETWORK.StaticNetworkMask=<subnet_mask>

Querying the Gateway Address

- ▶ GET•/MANAGEMENT/NETWORK.GatewayAddress

Setting a Static Gateway Address

- ▶ SET•/MANAGEMENT/NETWORK.StaticGatewayAddress=<gateway_address>

Encoder-related Commands

Querying the Input Video Signal Presence

- ▶ GET•/MEDIA/VIDEO/<in>.SignalPresent

Querying the Resolution of the Input Video Signal

- ▶ GET•/MEDIA/VIDEO/<in>.Resolution

Querying the Active Input Port

- ▶ GET•/MEDIA/VIDEO.InputSource

Querying the Video Input Selection Mode

- ▶ GET•/MEDIA/VIDEO.SelectionMode

Setting the Video Input Selection Mode

- ▶ SET•/MEDIA/VIDEO.SelectionMode=<sel_mode>

Querying the Video Quality Mode

- ▶ GET•/MEDIA/VIDEO/QUALITY.QualityMode

Setting the Video Quality Mode

- ▶ SET•/MEDIA/VIDEO/QUALITY.QualityMode=<quality_mode>

Querying the HDCP State

- ▶ GET•/MEDIA/VIDEO/<in>.HdcpState

Setting the HDCP State

- ▶ SET•/MEDIA/VIDEO/<in>.HdcpEnable=<HDCP_state>

Decoder-related Commands

Querying the Resolution of the Output Video Signal

- ▶ GET•/MEDIA/VIDEO/<out>.Resolution

Querying the Scaling Mode of the Output Video Signal

- ▶ GET•/MEDIA/VIDEO/<out>/SCALER.ScalingMode

Setting the Scaling Mode of the Output Video Signal

- ▶ SET•/MEDIA/VIDEO/<out>/SCALER.ScalingMode=<sc_mode>

Setting the Resolution of the Output Video Signal

- ▶ SET•/MEDIA/VIDEO/<out>/SCALER.OutputResolution

Querying the Signal Type of the Output Video Signal

- ▶ GET•/MEDIA/VIDEO/<out>/SCALER.SignalType

Setting the Signal Type of the Output Video Signal

- ▶ SET•/MEDIA/VIDEO/<out>/SCALER.SignalType=<sig_type>

Querying the State of the USB Connection

- ▶ GET•/MEDIA/KM.Controlling

Establishing the USB Connection

- ▶ CALL•/MEDIA/KM:acquireControl(true)

Audio-related Commands**Querying the Audio Input Selection Mode**

- ▶ GET•/MEDIA/AUDIO.ioSelect

Setting the Audio Input Selection Mode

- ▶ SET•/MEDIA/AUDIO.ioSelect=<sel_mode>

Querying the Audio Signal Presence

- ▶ GET•/MEDIA/AUDIO/<in>.SignalPresent

Querying the Volume (Exact Value)

- ▶ GET•/MEDIA/AUDIO/<port>.AnalogVolumedB

Setting the Volume (Exact Value)

- ▶ SET•/MEDIA/AUDIO/<port>.AnalogVolumedB=<value>

Setting the Volume (by a Step Value)

- ▶ CALL•/MEDIA/AUDIO/<port>:stepVolumeDb=<value>

Querying the Volume (in Percentage)

- ▶ GET•/MEDIA/AUDIO/<port>.AnalogVolume

Setting the Volume (in Percentage)

- ▶ SET•/MEDIA/AUDIO/<port>.AnalogVolume=<value>

Setting the Volume (by a Step Value in Percentage)

- ▶ CALL•/MEDIA/AUDIO/<port>:stepVolumePercent=<value>

Querying the Mute State

- ▶ GET•/MEDIA/AUDIO/<port>.AnalogMute

Setting the Mute State

- ▶ GET•/MEDIA/AUDIO/<port>.AnalogMute

Serial Port Settings**Setting the Port Availability**

- ▶ SET•/MEDIA/UART/<port>.Enabled=<port_status>

Setting the Baud Rate of the Port

- ▶ SET•/MEDIA/UART/<port>.Baudrate=<Baud_value>

Setting the RS-232 Port Mode

- ▶ SET•/MEDIA/UART/<port>.Guest=<port_mode>

Setting the Data Bits

- ▶ SET•/MEDIA/UART/<port>.DataBits=<Databits_value>

Setting the Stop Bits

- ▶ SET•/MEDIA/UART/<port>.StopBits=<Stopbits_value>

Setting the Parity

- ▶ SET•/MEDIA/UART/<port>.Parity=<parity_setting>

Arranging the Extenders to Groups**Querying the Working Mode (Unicast/Multicast)**

- ▶ GET•/MANAGEMENT/MULTICAST.MulticastMode

Setting the Working Mode (Unicast/Multicast)

- ▶ SET•/MANAGEMENT/MULTICAST.MulticastMode=<Multicast_mode>

Querying the Video Stream ID Setting Method

- ▶ GET•/SYS/MB/PHY.ChannelIdSetBySoftware

Querying the DIP Switch Value

- ▶ GET•/SYS/MB/GPIO.DipSwitch

Querying the Video Stream ID

- ▶ GET•/SYS/MB/PHY.VideoChannelId

DIP Switch Enable

- ▶ SET•/SYS/MB/GPIO.DipSwitchEnable=<switch_valid>

Setting the Video Stream ID

- ▶ SET•/SYS/MB/PHY.VideoChannelId=<channel_ID>

Video Wall Settings**Setting the Name of the Video Wall**

- ▶ SET•/MEDIA/VIDEO/O1/VIDEOWALL.Name=<wall_name>

Assigning a Decoder to a Video Wall

- ▶ SET•/MEDIA/VIDEO/O1/VIDEOWALL.Layout=<wall_parameters>

7

Firmware Upgrade

The devices can be upgraded via the built-in web page or by the Lightware Device Updater v2 (LDU2) software. The software is available at www.lightware.com. In order to get the firmware pack with the necessary components (*.lfp or *.lfp2 file) for your specific product, please contact support@lightware.com.

- ▶ [BUILT-IN WEB OR LDU2](#)
- ▶ [IMPORTANT NOTICES – BEFORE STARTING THE UPGRADE](#)
- ▶ [ABOUT THE FIRMWARE PACKAGE \(LFP/LFP2 FILE\)](#)
- ▶ [OPTION 1. – UPGRADING VIA THE BUILT-IN WEB PAGE](#)
- ▶ [OPTION 2. – UPGRADING BY LDU2](#)
- ▶ [RUNNING THE SOFTWARE](#)
- ▶ [THE UPGRADING STEPS](#)
- ▶ [IF THE UPGRADE IS NOT SUCCESSFUL](#)

7.1. Built-in Web or LDU2

The firmware of the VINX device can be upgraded by two ways. The following table contains the features of the methods:

Function	Built-in Web	LDU2
Platform	Mozilla Firefox, Google Chrome	Windows, mac OS
Installation	Web browser needed only	Required
LFP file support	✓	-
LFP2 file support	✓	✓
Log export	-	✓

7.2. Important Notices – Before Starting the Upgrade

- **Upgrade all VINX devices** within a system. Make sure that the same firmware runs on the devices. If the firmwares are different the seamless operation is not guaranteed.
- While the firmware is being upgraded **signal processing is not performed**. The normal operation mode is suspended as the device is switched to bootload mode.
- **Do not interrupt** the firmware upgrade. If any problem occurs, reboot the device and restart the process.
- The settings and parameters (e.g. User EDID memory, video wall settings) **will not be lost** by upgrading the firmware.

7.3. About the Firmware Package (LFP/LFP2 File)

The firmware files are packed in an LFP/LFP2 package. You need only this file to do the upgrade in your device.

- The package contains all the necessary components, binary, and other files; You do not have to get further files.
- There is a descriptor file in the package that contains each firmware with version number and a list showing the compatible devices which is displayed in Lightware Device Updater v2 (LDU2) after loading.

7.4. Option 1. – Upgrading via the Built-in Web Page

WARNING! Never disconnect the power source from the VINX devices during the upgrade! Interrupting the firmware upgrade may cause the device unusable.

This method is available by the built-in web page of the VINX device. We recommend this way of upgrade if you do not have the chance to install a software or you have just a few devices.

7.4.1. Firmware Upgrading Steps

- Step 1.** Get the necessary **firmware pack** (*.lfp or *.lfp2 file) and save it to the control device (computer/mobile device).
- Step 2.** **Establish the connection** from the computer/mobile device to the desired VINX extender as described in the [Connecting via the Built-in Web Page](#).
- Step 3.** Navigate to the **Advanced Settings** tab.
- Step 4.** Locate the **Upgrade Firmware** section and press the **Choose file** button. Browse the firmware package file and press the **OK**.

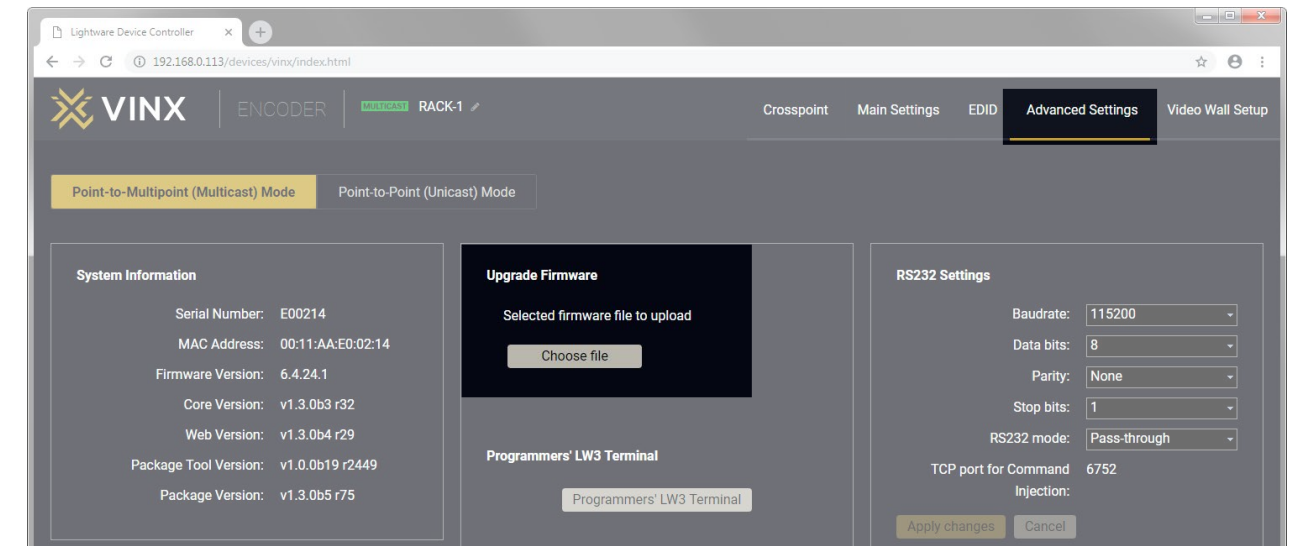

Firmware Upgrade via the Built-in Web Page

- Step 5.** Press the **Upgrade Firmware** button. The firmware pack will be uploaded into the device and the upgrade process is started automatically.
- Step 6.** The progress bar and a short label will show the current state of the process.

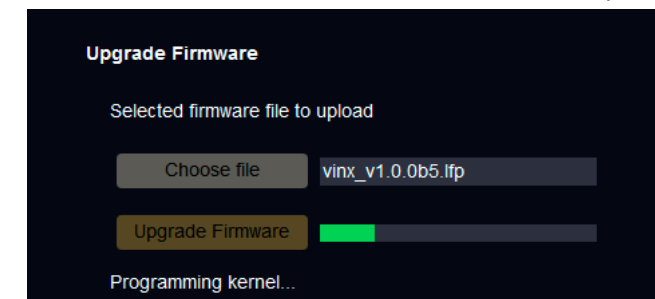

- Step 7.** When the programming is finished, the device will reboot and the connection will be lost. Powering off and on again the device is recommended.

INFO: LFP and LFP2 packages are also accepted for upgrading via the built-in web.

7.5. Option 2. – Upgrading by LDU2

7.5.1. Introduction

Lightware Device Updater v2 (LDU2) software is the second generation of the LFP-based (Lightware Firmware Package) firmware upgrade process.

DIFFERENCE: The software can be used for uploading the packages with LFP2 extension only. LDU2 is not suitable for using LFP files, please use the LDU software for that firmware upgrade.



7.5.2. Preparation

Most Lightware devices can be controlled over more interfaces (e.g. Ethernet, USB, RS-232). But the firmware can be upgraded usually over one dedicated interface, which is the Ethernet in most cases.

If you want to upgrade the firmware of one or more devices you need the following:

- **LFP2 file,**
- **LDU2 software** installed on your PC or Mac.

Both can be downloaded from www.lightware.com/downloads.

Optionally, you can download the **release notes** file in HTML format.

7.5.3. About the Firmware Package (LFP2 File)

All the necessary tools and binary files are packed into the LFP2 package file. You need only this file to do the upgrade on your device.

- This allows the use of the same LFP2 package for different devices.
- The package contains all the necessary components, binary, and other files.
- The release notes is included in the LFP2 file which is displayed in the window where you select the firmware package file in LDU2.

7.5.4. LDU2 Installation

ATTENTION! Minimum system requirement: 2 GB RAM.

INFO: The Windows and the Mac application has the same look and functionality.

Download the software from www.lightware.com/downloads.

Installation in case of Windows OS

Run the installer. If the User Account Control displays a pop-up message click **Yes**.

Installation Modes

Normal install	Snapshot install
Available for Windows and MacOS	Available for Windows
The installer can update only this instance	Cannot be updated
One updateable instance may exist for all users	Many different versions can be installed for all users

ATTENTION! Using the default Normal install is highly recommended.

INFO: If you have a previously installed version you will be prompted to remove the old version before installing the new one.

Installation in case of macOS X

Mount the DMG file with double clicking on it and drag the LDU2 icon over the Applications icon to copy the program into the Applications folder. If you want to copy LDU2 into another location just drag the icon over the desired folder.

INFO: This type of installer is equal with the **Normal install** of Windows.

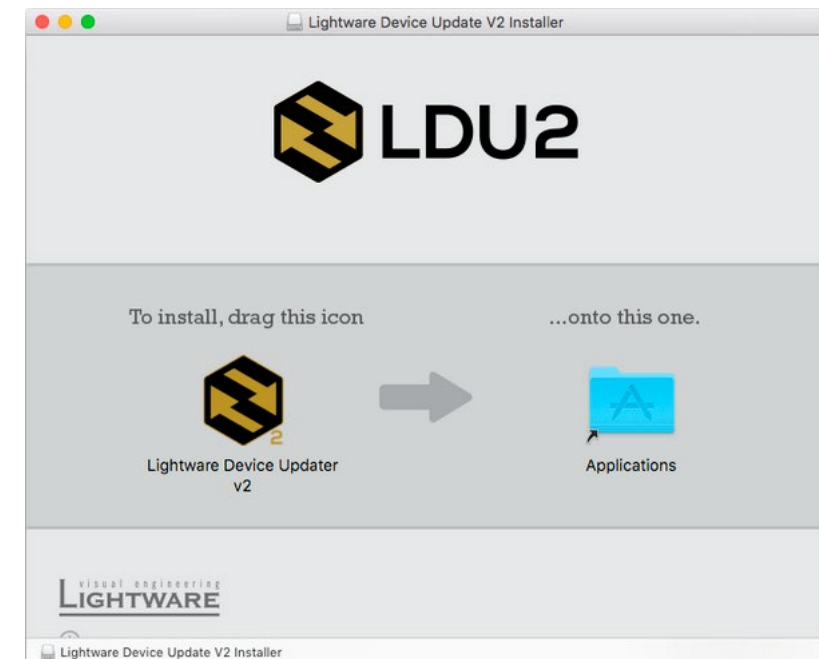

7.6. Running the Software

You have two options:

- **Starting the LDU2** by double-clicking on the shortcut/program file, or
- Double-clicking on an **LFP2 file**.

LDU2 Auto-Update

At startup, the software checks if a newer version is available on the web.

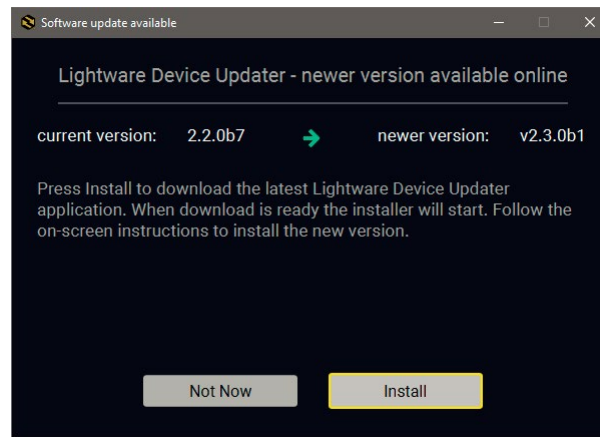

Main Screen

When the software is started by the shortcut, the device discovery screen appears. Press the **Search for devices** button to start finding the Lightware devices:

SEARCH FOR DEVICES

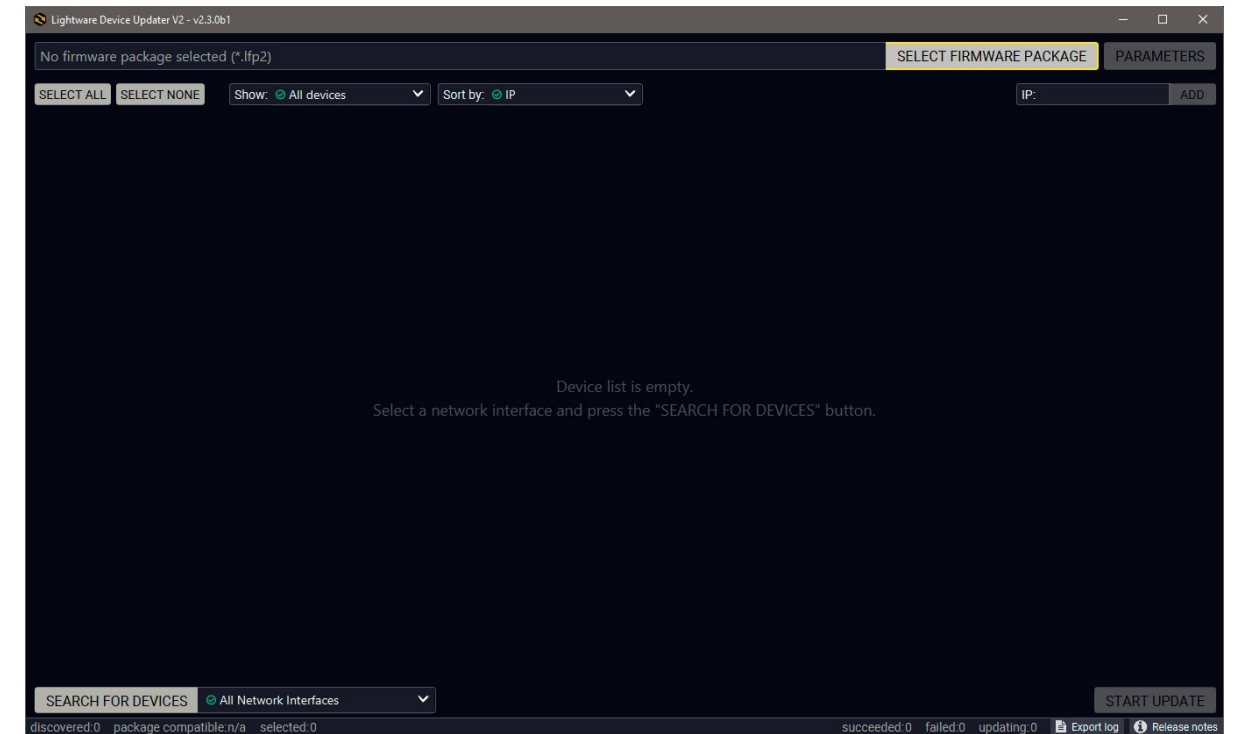

If you start the software by double-clicking on the LFP2 file, the firmware will be loaded. Press the **Search for devices** button; all the devices will be listed which are compatible with the selected firmware pack.





INFO: If you press the **Select firmware package** button, the release notes of the LFP2 file will be displayed in the right panel; see the [Step 1. Select the Firmware Package.](#) section.

Device List

When the discovery has completed, the devices available on the network are listed in the application.

Device ID	Device Name	IP Address	Package	Hardware
7.	UBEX-PRO20-HDMI-F100 Noe UBEX-ENG-6069	IP: 172.24.5.13 S/N: 00006069	PACKAGE: v1.5.0b5 FW: v1.5.0b5	HW: V13_AAAX
8.	UBEX-PRO20-HDMI-F120 UBEX-PRO20-HDMI-F120	IP: 172.24.5.14 S/N: 92140018	PACKAGE: v1.5.0b5 FW: v1.5.0b5	HW: V13_BAAX
9.	UBEX-MMU-X200 UBEX-MMU-X200	IP: 172.24.5.15 S/N: 00005611	PACKAGE: v1.3.0b6 FW: v1.3.0b6	HW: V10_AAAX
10.	VINX-120-HDMI-ENC Noe VINX-ENC	IP: 172.24.5.17 S/N: E00010	PACKAGE: v2.0.1b3 FW: v2.0.1b1	HW:
11.	VINX-110-HDMI-DEC Noe VINX-DEC	IP: 172.24.5.18 S/N: E80002	PACKAGE: v2.0.1b3 FW: v2.0.1b1	HW:
12.	UMX-TPS-TX140-Plus UMX-TPS-TX140-Plus	IP: 172.24.5.19 S/N: 00006074	PACKAGE: v1.4.0b8 FW: v1.4.0b5	HW: V11_GAX0

Legend of the Icons

-  **IP address editor** The IP address of the device can be changed in the pop-up window.
-  **Identify me** Clicking on the icon results the front panel LEDs blink for 10 seconds which helps to identify the device physically.
-  **Favorite device** The device has been marked, thus the IP address is stored. When a device is connected with that IP address, the star will be highlighted in that line.
-  **Further information available** Device is unreachable. Change the IP address using the front panel LCD menu or the IP address editor of the LDU2.

7.7. The Upgrading Steps

ATTENTION! While the firmware is being upgraded, the normal operation mode is suspended as the device is switched to bootload mode. Signal processing is not performed. Do not interrupt the firmware upgrade. If any problem occurs, reboot the unit and restart the process.

Keeping the Configuration Settings

By default, device configuration settings are restored when firmware upgrade is finished. If factory reset has been chosen in the parameters window, all device settings will be erased. In the case of factory reset, you can save the settings of the device in the Lightware Device Controller software and restore it later.

The following flow chart demonstrates how this function works in the background.

1. Create a backup

The current configuration of the device is being saved into a configuration backup file on your computer.

2. Start the Upgrade

The device reboots and starts in bootload mode (firmware upgrade mode).

3. Upgrade

The CPU firmware is changed to the new one.

4. Factory reset

All configuration settings are restored to the factory default values.

5. Conversion / Restore

The firmware package checks the backup data before the restore procedure, and if it is necessary, a conversion is applied to avoid incompatibility problems between the firmware versions. All configuration settings are restored to the device after the conversion.

If the factory default option is selected in the Parameters window, the conversion / restore procedure will not be performed!

6. Finish

Once the firmware upgrade procedure is finished, the device reboots and is ready to use.

Step 1. Select the Firmware Package.

Click on the **Select Firmware Package** button and navigate to the location where the LFP2 file was saved. When you click on the name of package, the preview of the release notes are displayed in the right panel.

SELECT FIRMWARE PACKAGE

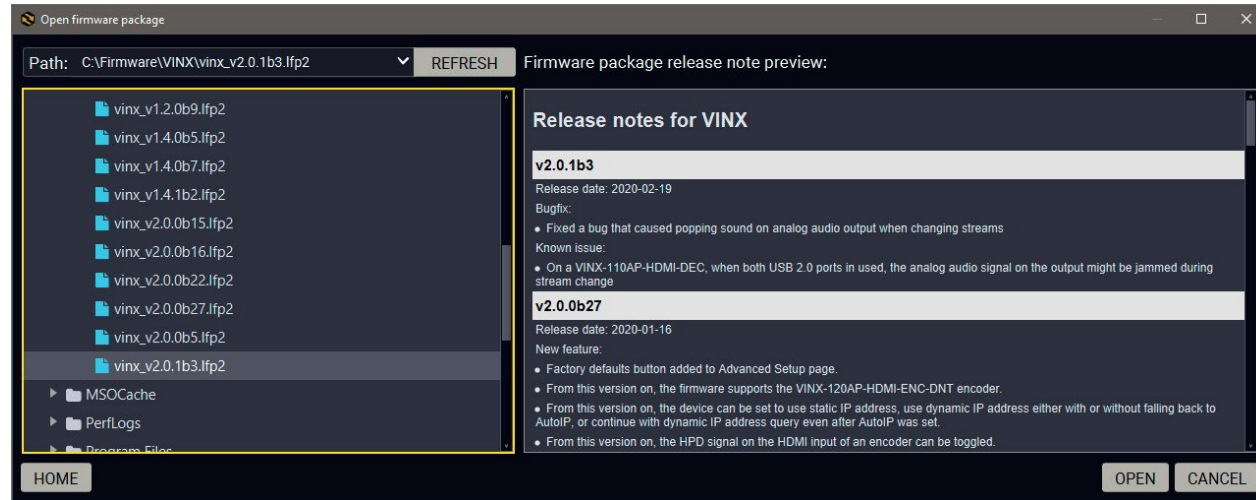

After the package file is loaded, the list is filtered to show the compatible devices only. The current firmware version of the device is highlighted in orange if it is different from the version of the package loaded.

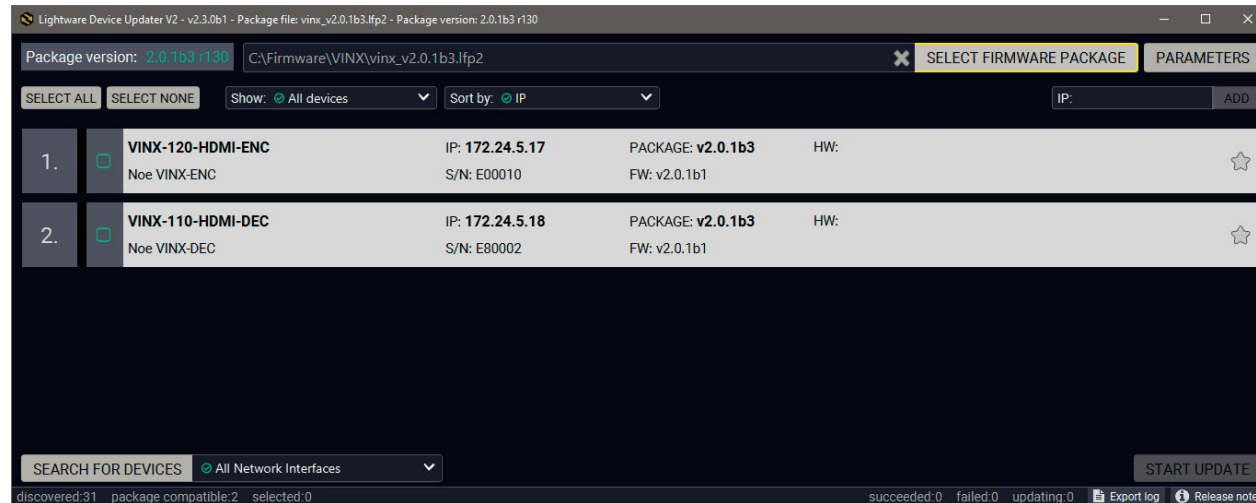

INFO: If you start the upgrade by double-clicking on the LFP file, above screen will be loaded right away.

The Meaning of the Symbols



Show details

Service mode

The log about the upgrading process of the device can be displayed in a new window.

The device is in bootload mode. Backup and restore cannot be performed in this case.

Step 2. Select the desired devices for upgrading.

Select the devices for upgrading; the selected line will be highlighted in green.

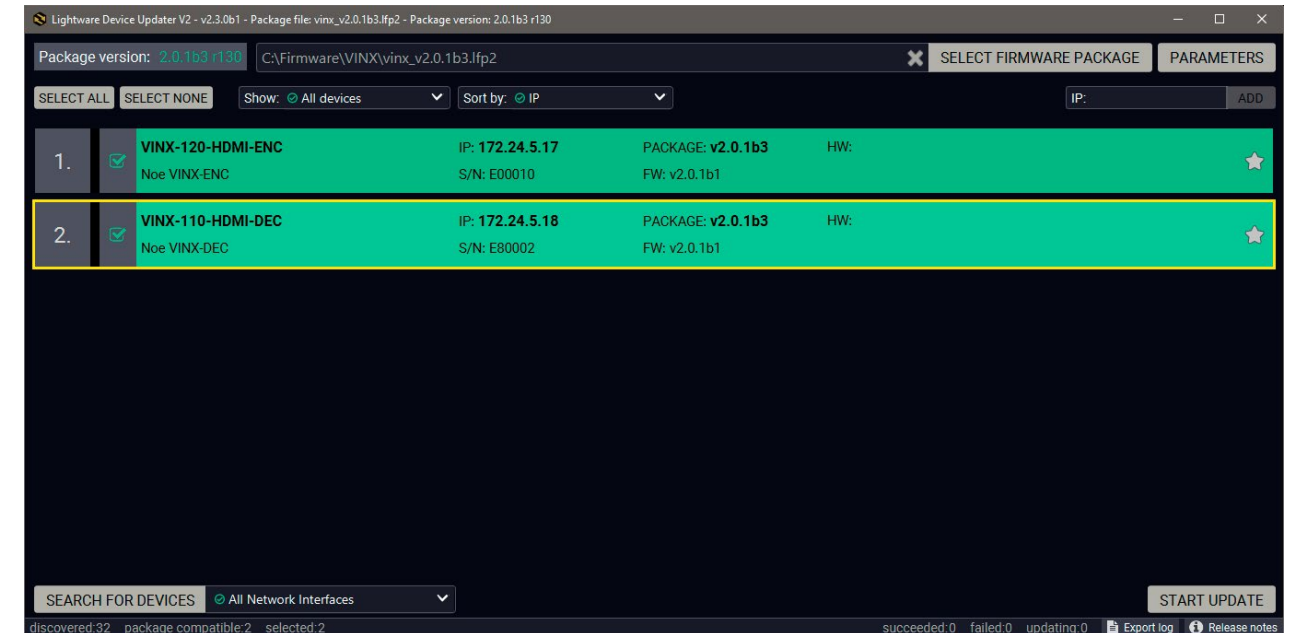

Step 4. Start the update and wait until it is finished.

Click on the **Start Update** button to start the procedure. The status is shown in percent in the right side of the device line and the overall process in the bottom progress bar.

START UPDATE

INFO: The device might reboot during the firmware upgrade procedure.

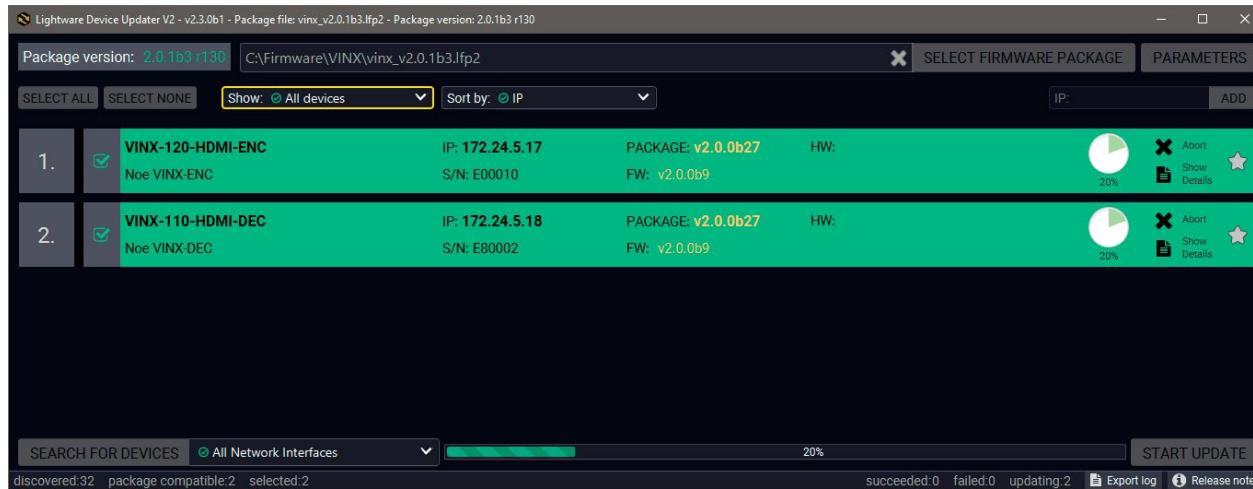

When the progress bar reaches 100% (**Done** is displayed at all devices), the upgrade of all devices are finished successfully and a message appears; you can close the software.

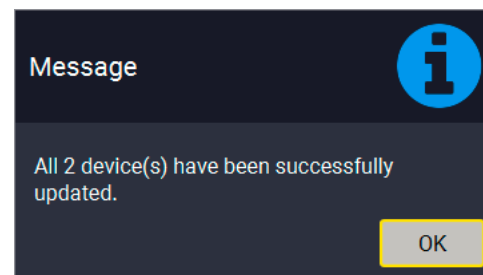
**Step 5. Wait until the unit reboots with the new firmware.**

Once the firmware upgrade procedure is completed, the device is rebooted with the new firmware. Shutting down and restarting the device is recommended.

7.8. If the Upgrade is not succesful





- Restart the process and try the upgrade again.
- If the device cannot be switched to bootload (firmware upgrade) mode, you can do that manually as written in the User's manual of the device. Please note that backup and restore cannot be performed in this case.
- If the backup cannot be created for some reason, you will get a message to continue the process without backup or stop the upgrade. A root cause can be that the desired device is already in bootload (firmware upgrade) mode, thus, the normal operation mode is suspended and backup cannot be made.
- If an upgrade is not succesful, the **Export log** button becomes red. If you press the button, you can download the log file as a ZIP package which can be sent to Lightware Support if needed. The log files contain useful information about the circumstances to find the root cause. *#bootload*

8











Troubleshooting

Usually, if the system seems not to transport the signal as expected, the best strategy for troubleshooting is to check signal integrity through the whole signal chain starting from source side and moving forward to receiver end.

Pictogram Legend

-  Link to the section of connections/cabling.
-  Link to the section of front panel operation.
-  Link to the section of the built-in web page.
-  Link to the section of LW3 protocol commands.

At first, check front panel LEDs and take the necessary steps according to their states. For more information about front and rear panel LEDs of the devices refer to the [VINX-120-HDMI-ENC](#) and [VINX-110-HDMI-DEC](#) sections.

Symptom	Root cause	Action	Refer to
Video issues			
No video on the screen	No video signal on the input.	Check the source and the cable connections.	
	The Video Stream IDs are different.	Check the settings of the extenders and assign them.	 5.4.1
	HDCP is disabled (EDID information cannot be read)	Enable the HDCP on the input of the Encoder. (In certain cases, the source device cannot read the EDID from the Encoder.)	 5.4.2
	HDCP-encrypted content sent to a non-HDCP sink.	Replace the sink to a HDCP-capable one.	
Network issues			
Cannot connect to an extender	The extenders did not get IP address.	The Ethernet switch needs more time to be ready than the extenders. Reboot the VINX devices.	
	The extender is not connected.	Check the LEDs and the cable connections.	 2.1 2.2
	The extenders and the PC are not in the same subnet.	Make sure the devices are located in the same subnet.	
USB issues			
The video stream cannot be changed by the keyboard shortcut	The keyboard is connected to an USB 2.0 port.	Connect the keyboard to the USB 1.1 port.	
	Shortcut is not assigned properly.	Check the settings and set the shortcut(s) again.	 5.4.1
	The keyboard is connected to another Decoder.	Connect it to the desired Decoder.	
USB data transmission does not work	Another Decoder is selected for USB transmission.	Check the LEDs or the USB settings in the built in web page.	 2.2  5.8.2
	The Encoder and the computer are not connected over USB.	Connect the supplied USB cable between the computer and the Encoder.	

How to Speed Up the Troubleshooting Process

Lightware's technical support team is always working hard to provide the fastest support possible. Our team's response time is one of the best in the industry and in the toughest of cases we can directly consult with the hardware or software engineer who designed the product to get the information from the most reliable source.

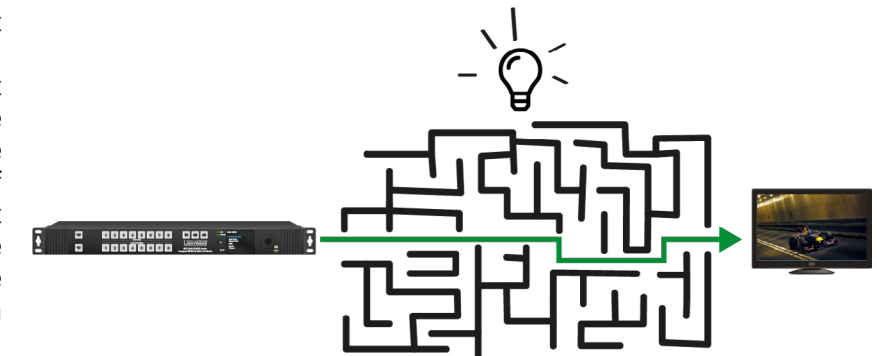

However, the troubleshooting process can be even faster... with your help.

There are certain pieces of information that push us in the right direction to finding the root cause of the problem. If we receive most of this information in the first e-mail or it is gathered at the time when you call us, then there is a pretty high chance that we will be able to respond with the final solution right away. This information is the following:

- Schematic (a pdf version is preferred, but a hand drawing is sufficient).
- Serial number(s) of the device(s) (it is either printed somewhere on the box or you can query it in the Device Controller software or on the built-in website).
- Firmware versions of the devices (please note that there may be multiple CPUs or controllers in the device and we need to know all of their firmware versions, a screenshot is the best option).
- Cable lengths and types (in our experience, it's usually the cable).
- Patch panels, gender changers or anything else in the signal path that can affect the transmission.
- Signal type (resolution, refresh rate, color space, deep color).
- Emulated EDID(s) (please save them as file and send them to us).
- Actions to take in order to re-create the problem (if we cannot reproduce the problem, it is hard for us to find the cause).
- Photo or video about the problem ('image noise' can mean many different things, it's better if we see it too).
- Error logs from the Device Controller software.
- In the case of Event Manager issue the event file and/or backup file from the Device Controller software.
- The more of the above information you can give us the better. Please send these information to the Lightware Support Team (support@lightware.com) to speed up the troubleshooting process.

9

Technologies

The following sections contain descriptions and useful technical information how the devices work in the background. The content is based on experiences and cases we met in the practice. These sections help to understand features and technical standards like the following:

- ▶ [EDID MANAGEMENT](#)
- ▶ [VIDEO OVER IP](#)
- ▶ [HDCP MANAGEMENT](#)
- ▶ [RS-232 SIGNAL MANAGEMENT \(VINX AP-SERIES\)](#)

9.1. EDID Management

9.1.1. Understanding the EDID

The Extended Display Identification Data (EDID) is the passport of display devices (monitors, TV sets, projectors). It contains information about the capabilities of the display, such as supported resolutions, refresh rates (these are called Detailed Timings), the type and manufacturer of the display device, etc.

After connecting a source to a display (DVI, HDMI, DP), the source reads out the EDID to determine the resolution and refresh rate of the image to be transmitted.

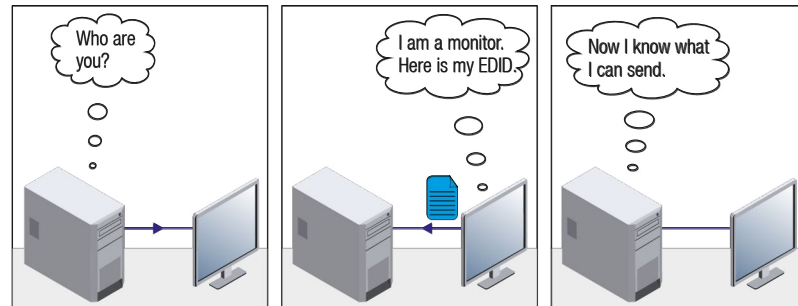

EDID Communication

Most DVI computer displays have 128-byte long EDID structure. However, Digital Televisions and HDMI capable displays may have another 128 bytes, which is called E-EDID and defined by CEA (Consumer Electronics Association). This extension contains information about additional Detailed Timings, audio capabilities, speaker allocation and HDMI capabilities. It is important to know that all HDMI capable devices must have CEA extension, but not all devices with CEA extension are HDMI capable.

Common Problems Related to EDID

- Problem:** “My system consists of the following: a computer, a Lightware device, a WUXGA (1920x1200) LCD monitor, and an SXGA (1280x1024) projector. I would like to see the same image on the monitor and the projector. What EDID should I choose on the Lightware device?”
- Solution:** If you want to see the image on both displays, you need to select the resolution of the smaller display (in this case SXGA), otherwise the smaller display may not show the higher resolution image.
- Problem:** “I have changed to a different EDID on an input port of the Lightware device to have a different resolution but nothing happens.”
- Solution:** Some graphics cards and video sources read out the EDID only after power-up and later they do not sense that EDID has been changed. You need to restart your source to make it read out the EDID again.

9.1.2. Advanced EDID Management

Each DVI sink (e.g. monitors, projectors, plasma displays, etc...) must support the EDID data structure. Source BIOS and operating systems are likely to query the sink using DDC2B protocol to determine what pixel formats and interface are supported. DVI standard uses EDID data structure to identify the monitor type and capabilities. Most DVI sources (VGA cards, set top boxes, etc.) will output DVI signal after accepting the connected sink's EDID information. In the case of EDID readout failure or missing EDID, the source will not output DVI video signal.

Lightware devices provide the Advanced EDID Management function that helps system integration. The built-in EDID Router can store and emulate factory pre-programmed- and User programmable EDIDs. The EDID of the attached monitors or projectors for each output are stored in a non-volatile memory. This way the EDID of a monitor is available when the monitor is unplugged or switched off.

Any EDID can be emulated on any input. An emulated EDID can be copied from the EDID router's memory (static EDID emulation), or from the last attached monitor's memory (dynamic EDID emulation). For example, the Lightware device can be set up to emulate a sink device, which is connected to one of the outputs. In this case, the EDID automatically changes, if the monitor is replaced with another display device (as long as it has a valid EDID).

EDID is independently programmable for all inputs without affecting each other. All inputs have their own EDID circuit.

INFO: The user is not required to disconnect the video cable to change an EDID as opposed to other manufacturer's products. EDID can be changed even if a source is connected to the input and powered ON.

INFO: When EDID has been changed, the router toggles the HOTPLUG signal for 2 seconds. Some sources do not sense this signal. In such cases, the source device must be restarted or powered OFF and ON again.

9.2. Video Over IP

Basics

Beside the traditional AV matrix switchers and extenders the video over IP or networked AV system is the biggest leading technology in the AV industry. The spreading of the technology speeds up the general increasing of the using of the IT-related devices and equipment all around the world - from the offices to the homes.

The main difference compared with the traditional AV technologies is the method of the signal transmission: the networked AV transmitter/encoder devices convert the video signal to TCP/IP packets and transfer them to the receivers/decoders. The interface of the transmission can be CATx or fiber optical cable depending on the signal bandwidth and the distance between the source and sink devices.

What is TCP/IP?

DEFINITION: TCP/IP, or the Transmission Control Protocol/Internet Protocol, is a suite of communication protocols used to interconnect network devices on the Internet or in a private network.

TCP/IP specifies how data is exchanged over the network by providing end-to-end communications that identify how it should be broken into packets, addressed, transmitted, routed and received at the destination. TCP/IP requires little central management, and it is designed to make networks reliable, with the ability to recover automatically from the failure of any device on the network. *

The two main protocols in the Internet protocol suite serve specific functions. TCP defines how applications can create channels of communication across a network. It also manages how a message is assembled into smaller packets before they are then transmitted over the Internet and reassembled in the right order at the destination address. *

IP defines how to address and route each packet to make sure it reaches the right destination. Each gateway computer on the network checks this IP address to determine where to forward the message. *

* Source: <https://searchnetworking.techtarget.com/definition/TCP-IP>

9.3. HDCP Management

Lightware Visual Engineering is a legal HDCP adopter. Several functions have been developed which helps to solve HDCP related problems. Complex AV systems often have both HDCP and non-HDCP components. The matrix allows transmitting HDCP encrypted and unencrypted signals. The devices will be still HDCP compliant as they will never output an encrypted signal to a non-HDCP compliant display device. If an encrypted signal is switched to a non-compliant output, a red screen alert or muted screen will appear.

9.3.1. Protected and Unprotected Content

Many video sources send HDCP protected signal if they detect that the sink is HDCP capable – even if the content is not copyrighted. This can cause trouble if an HDCP capable device is connected between the source and the display. In this case, the content cannot be viewed on non-HDCP capable displays and interfaces like event controllers. Rental and staging technicians often complain about certain laptops, which are always sending HDCP encrypted signals if the receiver device (display, matrix router, etc.) reports HDCP compliancy. However, HDCP encryption is not required all the time e.g. computer desktop image, certain laptops still do that.

To avoid unnecessary HDCP encryption, Lightware introduced the HDCP enabling/disabling function: the HDCP capability can be disabled in the Lightware device. If HDCP is disabled, the connected source will detect that the sink is not HDCP capable, and turn off authentication.

9.3.2. Disable Unnecessary Encryption

HDCP Compliant Sink

All the devices are HDCP-compliant, no manual setting is required, both protected and unprotected contents are transmitted and displayed on the sink.



Not HDCP-compliant Sink 1.

Not-HDCP compliant sink is connected to the matrix. Some sources (e.g. computers) always send HDCP encrypted signals if the receiver device reports HDCP compliancy, however, HDCP encryption is not required all the time (e.g. computer desktop image). If HDCP is enabled in the matrix, the image will not be displayed on the sink.



Setting the HDCP parameter to Auto on the output port and disable HDCP on the input port, the transmitted signal will not be encrypted if the content is not protected. Thus, non-HDCP compliant sinks will display non-encrypted signal.

Not HDCP-compliant Sink 2.

The layout is the same as in the previous case: non-HDCP compliant display device is connected to the matrix but the source would send protected content with encryption. If HDCP is enabled on the input port of the matrix, the source will send encrypted signal.



The sink is not HDCP compliant, thus, it will not display the video signal but blank screen is shown. If HDCP is disabled on the input port of the matrix, the source will not send the signal. The solution is to replace the display device to an HDCP-capable one.

9.3.3. HDCP v2.2

HDCP v2.2 is the latest evolution of copy protection. It is designed to create a secure connection between a source and a display. The 2.x version of HDCP is not a continuation of HDCPv1, and is rather a completely different link protection. One of the main differences is the number of the allowed devices within a closed A/V system: HDCP v2.2 allows 32 devices (HDCP v1.4 allows 128 devices). Further limit is that up to four level is allowed which means the protected signal can be transmitted over at most four repeater/matrix/switcher device. HDCP content protection is activated only if an active video stream is transmitted from the source to the display. The encryption is not activated without a video signal.

HDCP v2.2 standard allows to apply a previous version of HDCP (e.g. HDCP v1.4) between the source and the display if the source device allows it. According to the standard if the image content is protected with HDCP, the highest supported content protection level has to be applied. However, if the highest level of protection is not justified by the source content the level may be decreased to avoid compatibility problems; this case is determined by the source.

HDCP v2.2 Source and HDCP v1.4 Sink

In this case the signal of an HDCP v2.2 compliant source is switched to an HDCP v1.4 compliant sink device. The signal is encrypted with HDCP v2.2 on the input and encrypted with HDCP v1.4 on the output of the Lightware device. A lower level of encryption may be applied only if the source device/content allows it - according to the HDCP standard. In this case the HDCP setting on the input port has to be set to HDCP 1.4 and Depends on input on the output port.

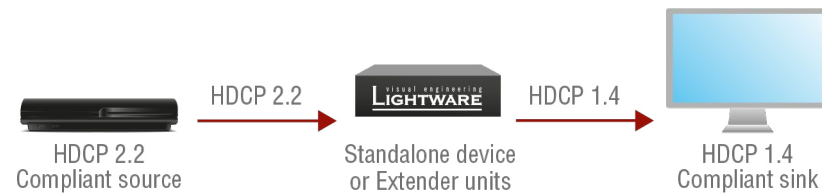

HDCP v1.4 Source and HDCP v2.2 Sink

The below example is the reversal of the previous case. An HDCP v1.4 compliant source sends a signal with HDCP v1.4 encryption. The signal is switched to an HDCP v2.2 compliant sink device. In this case the outgoing signal has to be encrypted with the highest supported encryption level towards the sink, as the Lightware device and the sink are both HDCP v2.2 compliant. The HDCP v2.2 standard does not allow keeping the original HDCP v1.4 encryption level on the output.



What Kind of Signal Will be on the Output of the Lightware Device?

See below table that summarizes the possible cases:

Incoming Signal	HDCP v1.4 Compatible Sink on the Output	HDCP v2.2. Compatible Sink on the Output
HDCP v1.4	HDCP v1.4	HDCP v2.2
HDCP v2.2 (convertable)*	HDCP v1.4	HDCP v2.2
HDCP v2.2 (not convertable)*	Red screen	HDCP v2.2

* Stream type 0: the video stream allows to convert the signal to apply a lower level of encryption.

** Stream type 1: the video stream does not allow to convert the signal.

9.4. RS-232 Signal Management (VINX AP-Series)

9.4.1. General Information

There are two types of devices in general serial communication:

- **Data Terminal Equipment:** Data Terminal Equipment (DTE) is an end instrument that converts user information into signals or reconverts received signals. Typical DTE devices: computers, LCD touch panels and control systems.
- **Data Circuit-terminating Equipment:** Data Circuit-terminating Equipment (DCE) is a device that sits between the DTE and a data transmission circuit. It is also called data communication equipment and data carrier equipment. Typical DCE devices: projectors, industrial monitors and amplifiers.

Among others the pin assignment is different between DTE and DCE.

	DTE	DCE
Pin 2:	RD	TD
Pin 3:	TD	RD



RD: Received Data (digital input)
TD: Transmitted Data (digital output)

Different type of serial cables must be used between different serial devices.

	DTE	DCE
DTE	Null-modem	TD
DCE	Straight	Null-modem*

* In general contact DCE with DCE by tail-circuit serial cable.

9.4.2. Types of Serial Cables

Straight Serial Cable	Null-modem Serial Cable
Straight pin-outs both ends.	Straight pin-out at the one end and cross pin-out at the other end (interchange lines of TX and RX).
	

Devices may have male or female plugs and their type can be straight or null-modem cables.

ATTENTION! The cable type does not depend on the plug type.

9.4.3. Serial Device Types

The types of VINX devices from serial data transmission point of view are the following:

VINX model	Unit type
VINX-120AP-HDMI-ENC, VINX-120AP-HDMI-ENC-DNT, VINX-210AP-HDMI-ENC	DCE
VINX-110AP-HDMI-DEC	DTE

9.4.4. RS-232 Signal Transmission over VINX Devices

The following examples show when source and sink devices are connected over Lightware's DCE- and DTE-type extenders for serial data transmission.

Data Transmission from a DCE Source to a DCE Sink Device

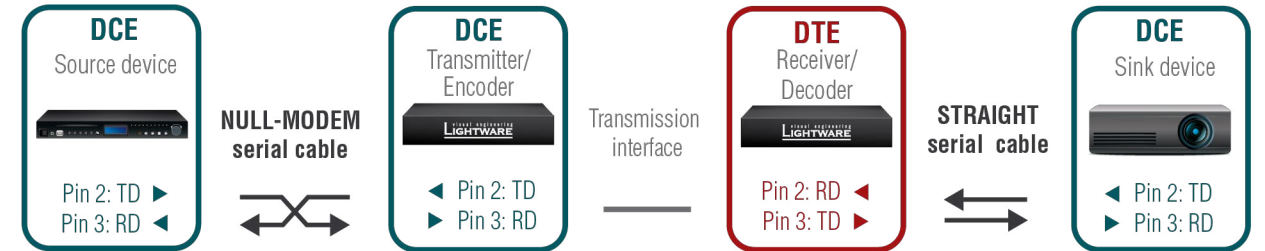

Data Transmission from a DCE Source to a DTE Sink Device

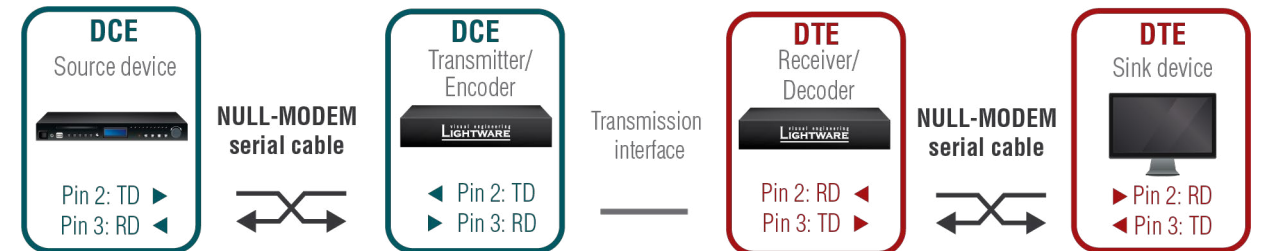

Data Transmission from a DTE Source to a DCE Sink Device

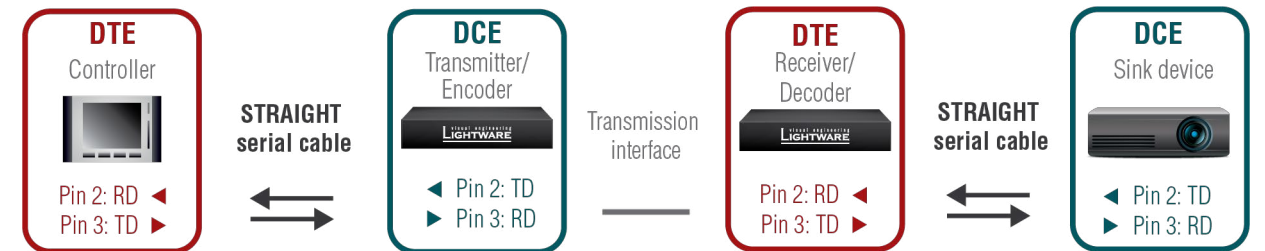

Data Transmission from a DTE Source to a DTE Sink Device

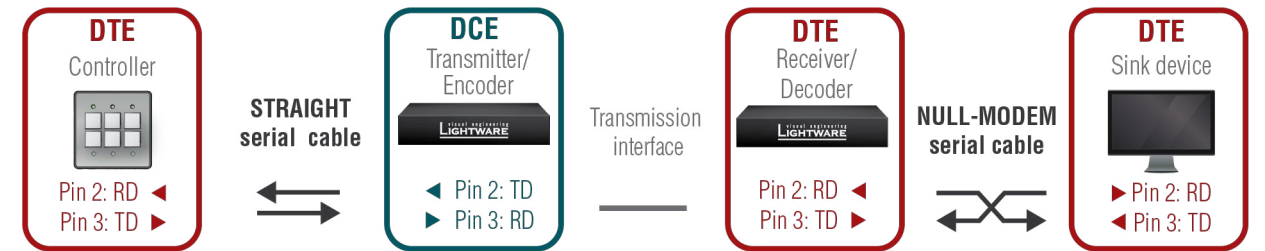

10

Appendix

Tables, drawings, guides, and technical details as follows:

- ▶ SPECIFICATIONS
- ▶ DELAY IN THE VIDEO TRANSMISSION
- ▶ FACTORY DEFAULT SETTINGS
- ▶ DIP SWITCH STATES
- ▶ MECHANICAL DRAWINGS
- ▶ OUTPUT RESOLUTIONS (SCALER)
- ▶ AUDIO PORT NUMBERING
- ▶ FACTORY EDID LIST
- ▶ FIRMWARE RELEASE NOTES
- ▶ APPLICATION NOTE (LW-AN-001)
- ▶ HASHTAG KEYWORD LIST
- ▶ FURTHER INFORMATION

10.1. Specifications

10.1.1. VINX Basic Series

Valid for VINX-120-HDMI-ENC and VINX-110-HDMI-DEC devices.

General

Compliance	CE
Electrical safety.....	IEC/EN 62368-1:2014
EMC (emission).....	IEC/EN 55032:2015
EMC (immunity)	IEC/EN 55035:2017
RoHS.....	EN 63000:2018
Warranty	3 years
Operating temperature	0° to +50°C (+32° to +122°F)
Operating humidity	10% to 90%, non-condensing
Cooling.....	Passive

Power

Power supply option.....	Power adaptor (supplied)
--------------------------	--------------------------

VINX-110-HDMI-DEC

Power consumption (min/max).....	3 W / 5W
Heat dissipation (min/max).....	11 BTU/h, 17 BTU/h

VINX-120-HDMI-ENC

Power consumption (min/max).....	4 W / 8.5W
Heat dissipation (min/max).....	14 BTU/h, 29 BTU/h

Power adaptor

Supported power source.....	100-240 V AC; 50/60 Hz
Supplied power	5 V DC, 3A
AC power plug.....	Interchangable (EU, UK, JP/US, AUS/NZ)
DC power plug.....	Locking DC connector (2.1/5.5 mm pin)

Enclosure

Enclosure material.....	1 mm steel
Dimensions in mm.....	100.4 W x 115 D x 26 H
Dimensions in inch	3.95 W x 4.53 D x 1.02 H
Weight.....	375 g

Video Input

HDMI Input Port

Connector type.....	19-pole HDMI type A receptacle
A/V standard.....	DVI 1.0, HDMI 1.4
HDCP Compliance	Yes, v2.2
Color space	RGB, YCbCr
Supported resolutions at 8 bits/color * up to 3840x2160@30Hz (4:4:4) or 3840x2160@60Hz (4:2:0) 1920x1080@60Hz (4:4:4) up to 12 bits/color
3D signal support.....	'Side-by-side' and 'Top-to-bottom' modes
Audio formats	Embedded LPCM, Dolby Digital 5.1 ch, Dolby Digital Plus, Dolby Digital Pro-Logic, Dolby TrueHD, DTS:X, Dolby Atmos, DTS 5.1 ch, DTS 96/24, DTS-ES Discrete, DTS-ES Matrix, DTS-HD High Resolution Audio, DTS-HD Master Audio

* All standard VESA, CEA and other custom resolutions up to 300MHz (HDMI1.4) are supported.

Video Output

HDMI Output Port

Connector type.....	19-pole HDMI type A receptacle
A/V standard.....	DVI 1.0, HDMI 1.4
HDCP Compliance	v2.2
Color space	RGB, YCbCr
Supported resolutions at 8 bits/color * up to 3840x2160@30Hz (4:4:4) or 3840x2160@60Hz (4:2:0) 1920x1080@60Hz (4:4:4) up to 12 bits/color
3D signal support.....	'Side-by-side' and 'Top-to-bottom' modes
Audio formats	Embedded LPCM, Dolby Digital 5.1 ch, Dolby Digital Plus, Dolby Digital Pro-Logic, Dolby TrueHD, DTS:X, Dolby Atmos, DTS 5.1 ch, DTS 96/24, DTS-ES Discrete, DTS-ES Matrix, DTS-HD High Resolution Audio, DTS-HD Master Audio

USB Ports

USB Port Type (Encoder).....	mini-B type receptacle
USB Port Type (Decoder).....	type-A receptacle, 4 pcs. 2x USB 1.1 and 2x USB 2.0 compliant
Data Communication Mode	transparent

RS-232 Ports

Connector type.....	RJ12 female receptacle
Baud rates	300, 600, 1200, 2400 4800, 9600, 19200, 38400, 57600, 115200 Baud
Data bits	6, 7, 8
Parity.....	None / Odd / Even
Stop bits	1 / 2
Data Communication Mode.....	Duplex, transparent

Infrared Ports

Output connector type (Encoder)	3.5 mm TS (1/8" jack)
Input connector type (Decoder)	3.5 mm TRS (1/8" jack)

10.1.2. VINX AP-series

Below specification data refer to the VINX-120AP-HDMI-ENC-DNT, VINX-120AP-HDMI-ENC, VINX-210AP-HDMI-ENC and VINX-110AP-HDMI-DEC devices.

General

Compliance	CE
Electrical safety.....	IEC/EN 62368-1:2014
EMC (emission).....	IEC/EN 55032:2015
EMC (immunity)	IEC/EN 55035:2017
RoHS.....	EN 63000:2018
Warranty	3 years
Operating temperature	0° to +50°C (+32° to +122°F)
Operating humidity	10% to 90%, non-condensing
Cooling.....	Passive

Power

Power supply option Power adaptor (supplied) / PoE
 Power over Ethernet (PoE) via AV in/out (IEEE802.3at)

VINX-110AP-HDMI-DEC

Power consumption (min/max) 3.6 W / 5.2W
 Heat dissipation (min/max) 13 BTU/h, 18 BTU/h

VINX-120AP-HDMI-ENC

Power consumption (min/max) 4.4 W / 7.5W
 Heat dissipation (min/max) 15 BTU/h, 25 BTU/h

VINX-120AP-HDMI-ENC-DNT

Power consumption (min/max) 4.4 W / 8.2W
 Heat dissipation (min/max) 15 BTU/h, 28 BTU/h

VINX-210AP-HDMI-ENC

Power consumption (min/max) 4.4 W / 8.3W
 Heat dissipation (min/max) 15 BTU/h, 28 BTU/h

Power adaptor

Supported power source 100-240 V AC; 50/60 Hz
 Supplied power 12V DC, 1A DC
 AC power plug Interchangable (EU, UK, JP/US, AUS/NZ)
 DC power plug Locking DC connector (2.1/5.5 mm pin)

Enclosure

Enclosure Material 1 mm steel
 Dimensions in mm 221W x 105.3D x 26H
 Dimensions in inch 8.7W x 4.14D x 1.02H
 Weight 665 g

SFP Module Slot

Number of port 1
 Supported data rate 1 Gbps
 Accepted interfaces SFP optical transceiver modules

Video Input**HDMI Input Port**

Connector type 19-pole HDMI type A receptacle
 A/V standard DVI 1.0, HDMI 1.4
 HDCP Compliance v2.2
 Color space RGB, YCbCr
 Supported resolutions at 8 bits/color *
 up to 3840x2160@30Hz (4:4:4) or 3840x2160@60Hz (4:2:0)
 1920x1080@60Hz (4:4:4) up to 12 bits/color
 3D signal support 'Side-by-side' and 'Top-to-bottom' modes
 Audio formats Embedded LPCM, Dolby Digital 5.1 ch,
 Dolby Digital Plus, Dolby Digital Pro-Logic, Dolby TrueHD,
 DTS:X, Dolby Atmos, DTS 5.1 ch, DTS 96/24, DTS-ES Discrete,
 DTS-ES Matrix, DTS-HD High Resolution Audio, DTS-HD Master Audio
 * All standard VESA, CEA and other custom resolutions up to 300MHz
 (HDMI1.4) are supported.

VGA Input Port

Connector type DE-15F (15-pole D-sub Female)
 Supported video signal Analog RGB and YPbPr video
 Color depth Up to 24 bits, 8 bit/color
 Max. resolution 1680x1050@60 Hz

Video Output**HDMI Output Port**

Connector type 19-pole HDMI Type A receptacle
 A/V standard DVI 1.0, HDMI 1.4
 HDCP compliance HDCP 2.2
 Color space RGB, YCbCr
 Supported resolutions at 8 bits/color *
 up to 3840x2160@30Hz (4:4:4) or 3840x2160@60Hz (4:2:0)
 1920x1080@60Hz (4:4:4) up to 12 bits/color

Audio formats Embedded LPCM, Dolby Digital 5.1 ch,
 Dolby Digital Plus, Dolby Digital Pro-Logic, Dolby TrueHD,
 DTS:X, Dolby Atmos, DTS 5.1 ch, DTS 96/24, DTS-ES Discrete,
 DTS-ES Matrix, DTS-HD High Resolution Audio, DTS-HD Master Audio
 * All standard VESA, CEA and other custom resolutions up to 300MHz
 (HDMI1.4) are supported.

USB Ports

USB Port Type (Encoder) B type receptacle
 USB Port Type (Decoder) type-A receptacle, 4 pcs.
 2x USB 1.1 and 2x USB 2.0 compliant
 Data Communication Mode transparent
 Data transmission rate (max) 5 MBit/s

RS-232 Ports

Serial Port Type 3-pole Phoenix connector
 Baud rates 300, 600, 1200, 2400
 4800, 9600, 19200, 38400, 57600, 115200 Baud
 Data bits 6, 7, 8
 Parity None / Odd / Even
 Stop bits 1 / 2
 Data Communication Mode Duplex, transparent

Infrared Ports

Output connector type (Encoder) 3.5 mm TS (1/8" jack)
 Input connector type (Decoder) 3.5 mm TRS (1/8" jack)

Analog Audio Input (VINX-120AP-HDMI-ENC and VINX-210AP-HDMI-ENC)

Connector type 3.5mm TRS (1/8" jack)
 Audio formats 2-ch PCM
 Sampling frequency 44.1 – 192 kHz
 Signal transmission unbalanced signal
 Volume adjustment -44 – 0 dB

Microphone Input (VINX-110AP-HDMI-DEC only)

Gain in the signal path *	+20dB
Peak level without distortion	-2.5dBFS (3% THD)
Total Harmonic Distortion (THD)	0.08% (refl: -12DBFS, 1kHz)
THD+Noise	0.3% (approx. -60dBFS)
Signal to Noise ratio (SNR)	62dBFS
Dynamic Range (DR)	72dBFS
Crosstalk	100% (mono channel)
Frequency response below 50Hz	above -3dB

* compared to the forward audio signal level. If this input is connected to a powered equipment hum noise issue may occur. This case an isolation transformer (a passive DI box) can help.

ATTENTION! The microphone input port applies a fixed bias to feed the connected electret (condenser) microphone. Thus it is not suitable for dynamic microphones which do not contain isolation or an impedance matching transformer. (Danger of damage of the microphone.)

Analog Audio Output

Connector type	3.5mm TRS (approx. 1/8" jack)
Audio formats	2-ch PCM
Signal transmission	unbalanced signal
Sampling frequency	44.1 kHz – 192 kHz
Volume adjustment	-44 – 0 dB

Dante® Audio Output Port

Connector type	RJ45 female connector
Signal transmission	Dante® or AES67
Supported channels	2-channel stereo
Sampling rates	44.1, 48, 96 kHz

INFO: Specifications subject to change without notice.

10.2. Delay in the Video Transmission

Due to the design of the devices frame delay is in the signal transmission from the Encoder towards the Decoder. Below tables show the cases and the measurable delay.

No Scaling, No Frame Rate Conversion

Input resolution	Output resolution	Delay	Frame delay
1080p60	1080p60	19ms	1.1
1080p50	1080p50	22ms	1.1
2160p25	2160p25	45ms	1.1
720p60	720p60	19ms	1.1

After the receiver got the signal, there is a synchronizing period (approx. 30 sec), then the frame delay stays constant as written above.

Active Scaling, No Frame Rate Conversion

Input resolution	Output resolution	Delay	Frame delay
720p60	1080p60	19ms	1.1
1280x960p60	1080p60	19ms	1.1
1080p25	2160p25	47ms - 100ms	
720p25	2160p25	47ms - 100ms	
1080p60	720p60	19ms	1.1
1080p30	2160p30	38ms	1.1

After the receiver got the signal, there is a synchronizing period (approx. 30 sec), then the frame delay stays constant as written above.

Active Frame Rate Conversion (Scaling Does Not Matter)

Input resolution	Output resolution	Delay (min)	Delay (max)
1080p60	1080p50	18ms	50ms
1080p29.97	1080p50	50ms	80ms
720p29.97	1080p50	50ms	80ms
720p29.97	2160p25	50ms	110ms
720p24	2160p25	70ms	110ms
1080p50	720p60	45ms	55ms

10.3. Factory Default Settings

Parameter	Setting/Value
IP address	Dynamic (AutoIP with DHCP fallback)
RS-232 port setting	115200 BAUD, 8, N, 1
DIP switch state	0000
Video stream ID	1
Connecting method	Multicast mode
Selected video input (VINX-210AP-HDMI-ENC)	Auto
Selected audio input	Auto#1
Emulated EDID (HDMI input)	F47 (Universal HDMI EDID)
Emulated EDID (VGA input)	F89 (Universal Analog EDID)
User EDID memory	Empty (cleared)
Output video mode (Encoder)	Movie mode
Output scaling (Decoder)	Pass-through, no rotation
Available video walls	Empty (cleared)

10.4. DIP Switch States

DIP switch state	Video Stream ID	/SYS/MB/GPIO.DipSwitch value
0000	SW setting	0x0
0001	1	0x1
0010	2	0x2
0011	3	0x3
0100	4	0x4
0101	5	0x5
0110	6	0x6
0111	7	0x7
1000	8	0x8
1001	9	0x9
1010	10	0xa
1011	11	0xb
1100	12	0xc
1101	13	0xd
1110	14	0xe
1111	15	0xf

10.5. Mechanical Drawings

The dimensions are in mm. Encoder and Decoder devices have the same size of chassis. The basic VINX devices are built into quarter-rack sized chassis, the AP-series have half-rack sized chassis.

Half-rack Sized Models

Front View

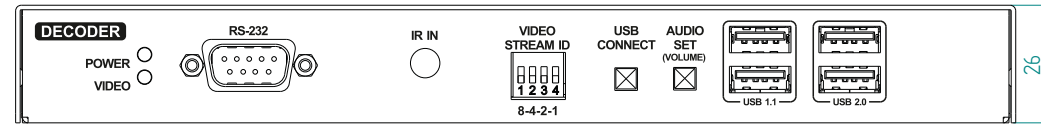

Top View

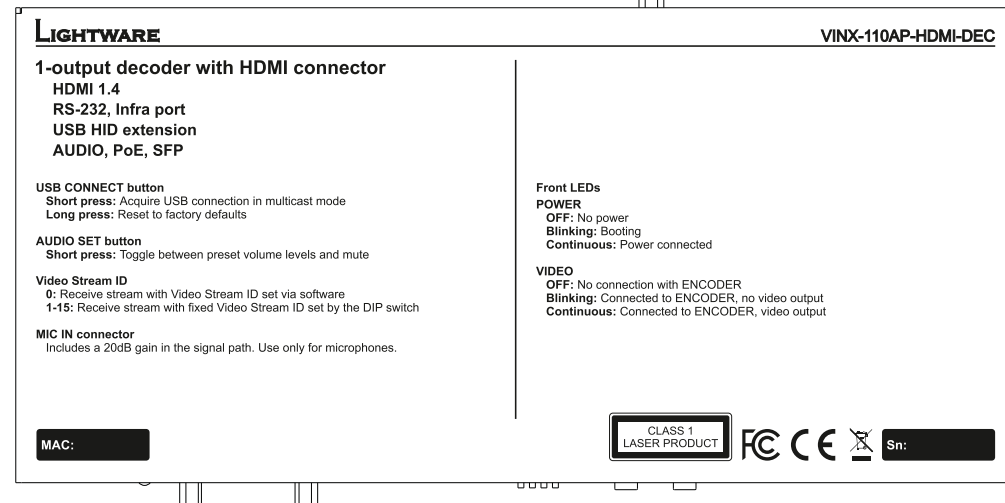

Rear View



Side View

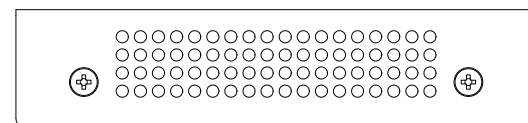

Bottom View

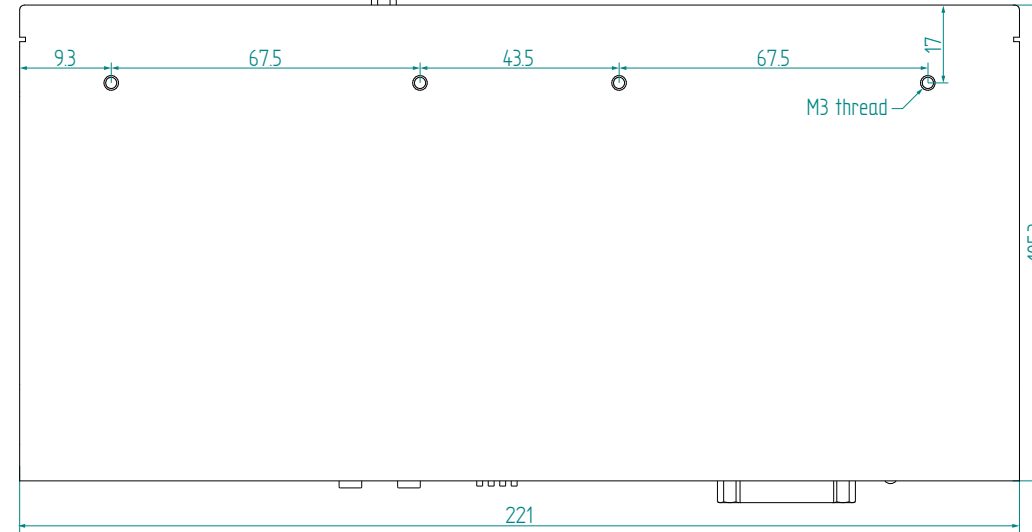

Quarter-rack Sized Models

Front View

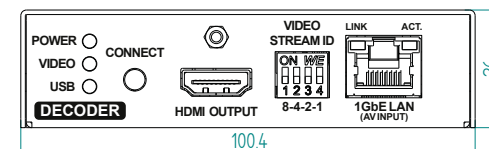

Rear View

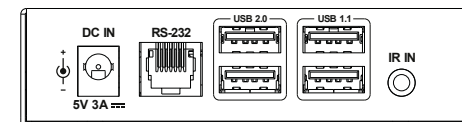

Side View

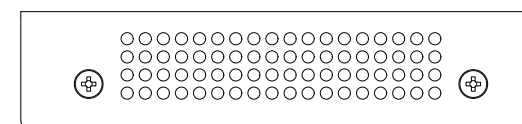

Top View

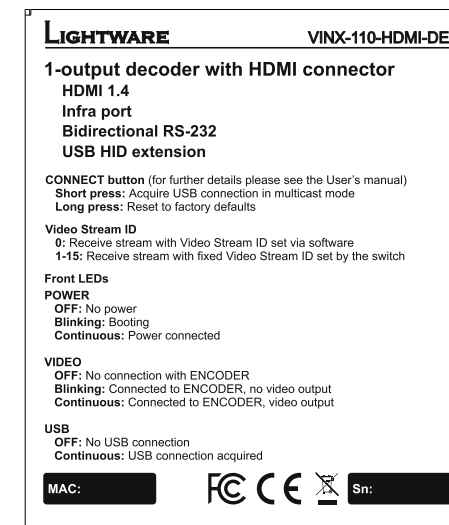

Bottom View

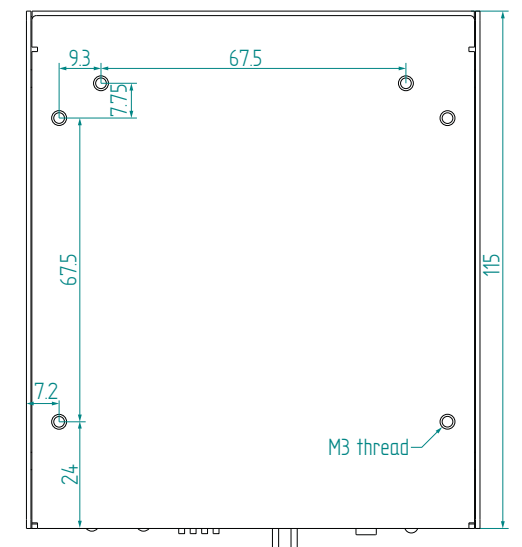

10.6. Output Resolutions (Scaler)

Resolution	Frame rate	HEX identifier
640x480	50	81004054
640x480	60	80000001
640x480	72	81004004
640x480	75	81004005
720x480 (480p)	60	81000002
720x576 (576p)	50	80000011
800x600	50	81004059
800x600	60	8100405A
800x600	72	81004009
800x600	75	8100400A
1024x768	50	8100405E
1024x768	60	8100405F
1024x768	75	81004060
1152x864	60	8100403E
1280x720 (720p)	50	80000013
1280x720 (720p)	60	80000004
1280x720 (720p)	75	81004089
1280x768	50	8100407B
1280x768	60	8100407C
1280x768	75	81004015
1280x800	60	81004040
1280x800	75	81004042
1280x960	50	81004063
1280x960	60	81004064
1280x1024	50	81004076
1280x1024	60	81004077
1280x1024	75	81004078
1360x768	50	8100408C
1360x768	60	8100408D
1360x768	75	8100408E

Resolution	Frame rate	HEX identifier
1366x768	60	81004048
1440x900	60	81004021
1440x900	75	81004023
1600x900	60	8100404E
1600x1024	60	810040EF
1600x1200	50	8100406A
1600x1200	60	8100406B
1680x1050	50	810040C1
1680x1050	60	810040C2
1920x1080i	25	80000014
1920x1080i	29.97	80000005
1920x1080 (1080p)	50	8000001F
1920x1080 (1080p)	60	80000010
1920x1200	50	810040C8
1920x1200	60	81004032
2560x1080	24	81000071
2560x1080	25	81000072
2560x1080	30	81000073
2560x1080	50	81000074
2560x1080	60	81000075
2560x1200	30	810040F0
2560x1200	60	810040F1
2560x1600	60	81004053
3840x2160	24	8000005D
3840x2160	25	8000005E
3840x2160	30	8000005F
4096x2160	24	80000062
4096x2160	25	80000063
4096x2160	30	80000064

10.7. Audio Port Numbering

VINX-210AP-HDMI-ENC

	Video port	Audio port
HDMI in	I1	I1
VGA in	I2	-
Analog in	-	I2
Analog out	-	O1

VINX-120AP-HDMI-ENC and VINX-120AP-HDMI-ENC-DNT

	Video port	Audio port
HDMI in	I1	I1
Analog in	-	I2
Analog out	-	O1

VINX-110AP-HDMI-DEC

	Video port	Audio port
HDMI out	O1	O1
Microphone in	-	I2
Analog out	-	O2

10.8. Factory EDID List

Mem.	Resolution				Scan type	EDID type
F1	640 x	480	@ 60.00	Hz	p	D
F4	1024 x	768	@ 60.00	Hz	p	D
F5	1280 x	768	@ 50.00	Hz	p	D
F6	1280 x	768	@ 59.94	Hz	p	D
F7	1280 x	768	@ 75.00	Hz	p	D
F8	1360 x	768	@ 60.02	Hz	p	D
F9	1280 x	1024	@ 50.00	Hz	p	D
F10	1280 x	1024	@ 60.02	Hz	p	D
F11	1280 x	1024	@ 75.02	Hz	p	D
F15	1680 x	1050	@ 60.00	Hz	p	D
F16	1920 x	1080	@ 50.00	Hz	p	D
F17	1920 x	1080	@ 60.00	Hz	p	D
F20	1600 x	1200	@ 50.00	Hz	p	D
F21	1600 x	1200	@ 60.00	Hz	p	D
F22	1920 x	1200	@ 50.00	Hz	p	D
F23	1920 x	1200	@ 59.56	Hz	p	D
F29	1920 x	1080	@ 60.00	Hz	p	U
F32	640 x	480	@ 59.95	Hz	p	H
F33	720 x	480	@ 59.94	Hz	p	H
F34	720 x	576	@ 50.00	Hz	p	H
F35	1280 x	720	@ 50.00	Hz	p	H
F36	1280 x	720	@ 60.00	Hz	p	H
F37	1920 x	1080	@ 50.04	Hz	i	H
F38	1920 x	1080	@ 50.00	Hz	i	H
F39	1920 x	1080	@ 60.05	Hz	i	H
F40	1920 x	1080	@ 60.05	Hz	i	H
F41	1920 x	1080	@ 24.00	Hz	p	H
F42	1920 x	1080	@ 25.00	Hz	p	H
F43	1920 x	1080	@ 30.00	Hz	p	H
F44	1920 x	1080	@ 50.00	Hz	p	H

Mem.	Resolution				Scan type	EDID type
F45	1920 x	1080	@ 59.94	Hz	p	H
F46	1920 x	1080	@ 60.00	Hz	p	H
F47	1920 x	1080	@ 60.00	Hz	p	U
F48	1920 x	1080	@ 60.00	Hz	p	U
F49	1920 x	1080	@ 60.00	Hz	p	U
F50	720 x	480	@ 30.03	Hz	i	A
F51	720 x	576	@ 25.04	Hz	i	A
F52	640 x	480	@ 60.00	Hz	p	A
F53	640 x	480	@ 75.00	Hz	p	A
F54	800 x	600	@ 50.00	Hz	p	A
F55	800 x	600	@ 60.32	Hz	p	A
F56	800 x	600	@ 75.00	Hz	p	A
F57	1024 x	768	@ 49.99	Hz	p	A
F58	1024 x	768	@ 60.00	Hz	p	A
F59	1024 x	768	@ 75.03	Hz	p	A
F60	1280 x	768	@ 50.00	Hz	p	A
F61	1280 x	768	@ 59.94	Hz	p	A
F62	1280 x	768	@ 75.00	Hz	p	A
F63	1360 x	768	@ 60.02	Hz	p	A
F64	1364 x	768	@ 50.00	Hz	p	A
F65	1364 x	768	@ 59.94	Hz	p	A
F66	1364 x	768	@ 74.99	Hz	p	A
F67	1280 x	1024	@ 50.00	Hz	p	A
F68	1280 x	1024	@ 60.02	Hz	p	A
F69	1366 x	1024	@ 60.00	Hz	p	A
F70	1400 x	1050	@ 50.00	Hz	p	A
F71	1400 x	1050	@ 60.00	Hz	p	A
F72	1400 x	1050	@ 75.00	Hz	p	A
F73	1920 x	540	@ 50.00	Hz	i	A
F74	1920 x	540	@ 60.00	Hz	i	A
F75	1920 x	1080	@ 50.00	Hz	p	A

Mem.	Resolution				Scan type	EDID type
F76	1920 x	1080	@ 60.00	Hz	p	A
F89	1920 x	1200	@ 59.56	Hz	p	U
F96	2560 x	1600	@ 59.86	Hz	p	D
F100	1024 x	768	@ 60.00	Hz	p	H
F101	1280 x	1024	@ 50.00	Hz	p	H
F102	1280 x	1024	@ 60.02	Hz	p	H
F103	1280 x	1024	@ 75.02	Hz	p	H
F104	1600 x	1200	@ 50.00	Hz	p	H
F105	1600 x	1200	@ 60.00	Hz	p	H
F106	1920 x	1200	@ 59.56	Hz	p	H
F108	2560 x	1600	@ 59.86	Hz	p	H
F110	3840 x	2160	@ 24.00	Hz	p	H
F111	3840 x	2160	@ 25.00	Hz	p	H
F112	3840 x	2160	@ 30.00	Hz	p	H
F118	3840 x	2160	@ 30.00	Hz	p	U
F119	3840 x	2160	@ 30.00	Hz	p	U
F125	1366 x	768	@ 60.00	Hz	p	H
F131	4096 x	2160	@ 25.00	Hz	p	H
F132	4096 x	2160	@ 30.00	Hz	p	H

Legend

D: DVI EDID

H: HDMI EDID

U: Universal EDID, supporting many standard resolutions:

- **F29:** Universal EDID for DVI signals (no audio support).
- **F47:** HDMI EDID supporting PCM audio.
- **F48:** HDMI EDID supporting all type of audio.
- **F49:** HDMI EDID supporting all type of audio and deep color.
- **F89:** Universal EDID for analog signals (no audio support).
- **F118:** HDMI EDID supporting PCM audio and 4K@30 Hz signals.
- **F119:** HDMI EDID supporting all type of audio and 4K@30 Hz signals.

10.9. Firmware Release Notes

Below list shows the released firmware packages with important notes.

v2.0.1b3

Release date: 2020-02-19

Bugfix:

- Fixed a bug that caused popping sound on analog audio output when changing streams

Known issue:

- On a VINX-110AP-HDMI-DEC, when both USB 2.0 ports in used, the analog audio signal on the output might be jammed during stream change

v2.0.0b27

Release date: 2020-01-17

New feature:

- Factory defaults button added to Advanced Setup page.
- From this version on, the firmware supports the VINX-120AP-HDMI-ENC-DNT encoder.
- From this version on, the device can be set to use static IP address, use dynamic IP address either with or without falling back to AutoIP, or continue with dynamic IP address query even after AutoIP was set.
- From this version on, the HPD signal on the HDMI input of an encoder can be toggled.
- Improved switching time considerably. (Switching time is the time elapsed between switching to another source and providing a stable output on the output HDMI port.)

Bugfix:

- Fixed a bug that resulted in some LW3 requests not to be executed when the sender closed the TCP connection before receiving an answer for the request from the VINX device.

v1.4.0b7

Release date: 2019-07-05

New feature:

- Added support for VINX-210AP-HDMI-ENC, VINX-120AP-HDMI-ENC, and VINX-110AP-HDMI-DEC.
- From this version on, the exact product name is presented to the user in the header of the built-in web and in LDC.

- From this version on, both the encoder and the decoder can be set whether or not to use jumbo frames. Note, that this setting is only available from LW3 and the decoder and the corresponding encoder shall be set to the same setting.

Bugfix:

- Fixed a bug that might have resulted in the Advanced Settings page to be rendered incorrectly at some resolutions.
- On a VINX-120-HDMI-ENC device, The EDID is not read from the sink connected to the local output of the encoder. Thus, it cannot be used as a dynamic EDID.
- Some parameters of the EDID emulated on the HDMI input of VINX-210AP-HDMI-ENC and VINX-120AP-HDMI-ENC (other than the preferred timing) might get modified.
- VINX-210AP-HDMI-ENC might indicate wrong resolution for incoming analog signals with frame rate of 50 Hz.
- On a VINX-110AP-HDMI-DEC, compressed audio might be output for a brief period of time which results in digital noise on the output.

Known issue:

- Pressing the front panel key (COMP MODE or USB CONNECT) for less than ten seconds might reset the device to its factory settings.
- On a VINX-120-HDMI-ENC device, The EDID is not read from the sink connected to the local output of the encoder. Thus, it cannot be used as a dynamic EDID.
- Some parameters of the EDID emulated on the HDMI input of VINX-210AP-HDMI-ENC and VINX-120AP-HDMI-ENC (other than the preferred timing) might get modified.
- VINX-210AP-HDMI-ENC might indicate wrong resolution for incoming analog signals with frame rate of 50 Hz.
- On a VINX-110AP-HDMI-DEC, compressed audio might be output for a brief period of time which results in digital noise on the output.

v1.3.0b5

Release date: 2018-12-18

New feature:

- Added controls for setting the RS-232 mode to Pass-through or Command injection.
- Added a Crosspoint tab to the graphical user interface. In the crosspoint tab it is possible to route any input to any output as long as the number of encoders and decoders in the subnet does not exceed 24 and the number of encoders is less or equal to 16.

Bugfix:

- Fixed a bug that caused the firmware upgrade to stop at 20% when upgrading through LDU2.
- Fixed a bug that caused the Output scaling radio button group to work hectically when the Output standard is set to DVI.

v1.2.1b1

Release date: 2018-10-24

Bugfix:

- Fixed a bug that resulted in wrong output format for scaling set to 1920x1080@50Hz.

v1.2.0b9

Release date: 2018-10-18

New feature:

- From this version on, the video mode related settings (Video quality as referred to in earlier versions) have been given a more descriptive and self explaining name.
- The Connect button in the Main Settings page has been renamed to Open Device.
- From this version on VINX devices are supported by the Lightware Device Manager.
- From this version on, the graphical user interface displays a preview image of the encoder input.
- Improved response time of the devices. As a result, changes made to the devices are reflected faster on the graphical user interface.
- The list of available output formats has been consolidated and a few output formats have been added.
- From this version on, the name of the device appears on the tab of the Programmers' LW3 Terminal window.

Bugfix:

- Fixed a bug that caused the video not to be transmitted properly in Unicast mode when switching Video Stream ID on the encoder.
- Fixed a bug that caused the Auto detect from EDID scaler feature not to work properly after a factory reset.
- Fixed a bug that caused the device to switch to Unicast mode from Multicast mode only at the second click on the corresponding button on the Advanced Settings page.
- Fixed a bug that let the user select two decoders to receive the same video stream in Unicast mode.
- Fixed a bug that caused the connection to the device to be lost when changing Video Stream ID on the decoder multiple times in rapid succession.

- Fixed a bug that caused the USB LED on the decoder not to reflect valid information when pressing the Connect button on several decoders connected to the same encoder in rapid successions multiple times.
- Added a warning message to state that the device having an Auto IP of 169.254.x.x cannot be detected after firmware upgrade as the IP address will change after a reboot.
- Fixed a bug that caused the Delete video wall button on the Video Wall Setup page to be active even if there is no video wall selected.
- Fixed a bug that let the user enter invalid value for stop bit in the LW3 tree view.
- Fixed a bug that caused the IGMP packets to be disregarded by certain switches due to missing Router Alert option from the IP header. Thus, it is no longer necessary to disable IP header validation on the switches.
- Fixed a bug that caused connection reset during firmware upgrade by LDU2.
- Fixed a bug that caused the Programmers' LW3 Terminal window to be rendered incorrectly at certain resolutions.

Known issue:

- The video wall being edited can lose focus when it is saved.
- The Output scaling radio button group works hectically when the Output standard is set to DVI.

v1.1.1b2

Release date: 2018-06-07

Bugfix:

- Fixed a bug that degraded switching speed.

v1.1.0b7

Release date: 2018-05-31

New feature:

- From this version on, the items in the Emulated EDID on input list reflect the monitor name field of the EDID instead of the format parameters for better identification.
- New EDIDs have been added to the factory EDID list.
- From this version on, the OSD messages that appear on the display connected to the VINX decoder are turned off by default. They can be turned on individually or globally, though.

- From this version on, information like the IP address of a decoder and the position within a video wall can be temporarily displayed on the monitor attached to a VINX decoder. This will ease the setup of video walls.
- For smooth video playback, the default operation mode has been changed from Graphic Mode to Video Mode.
- From this version on, VINX encoder and decoder units can be upgraded in batches by LDU2.
- It is now possible to disable (by an LW3 property) the DIP switch setting of the video stream ID.
- Version number of several components including package version has been added to the graphical user interface.
- It is now possible to set bandwidth limit for the encoded video stream generated by the encoder.
- It is now possible to create a list of favourite channels and associate shortcut keys to cycle through the list up and down. Moreover, shortcut keys can be associated with specific streams. The associated shortcut key, when pressed on a keyboard attached to a decoder, can be used to trigger the corresponding action.
- It is now possible to connect to an encoder from a decoder or to a decoder from an encoder by clicking on a Connect button in the list of available devices on the Main Settings page.

Bugfix:

- Fixed a bug that caused VINX-HDMI-120-ENC and VINX-HDMI-110-DEC not to be accessible via `http://lwr-gatewayAABBCCDDEEFF.local` or `http://lwr-clientAABBCCDDEEFF.local`, respectively, where AABBCCDDEEFF is the MAC address without colons of the device to be accessed.
- Fixed a bug that caused a decoder device to display invalid content when it was removed from a video wall.
- Fixed a bug that caused the VINX encoder to restart when the corresponding decoder was reading an EDID from the attached device that had a Video Format Preference block in its CEA extension.
- Fixed a bug that caused the RS-232 symbol rate not to be displayed correctly when a custom value was set via LW3.
- Known issue:
- When defining a shortcut key combination for switching to previous or next stream or for a stream shortcut, and the shortcut key combination has more modifier keys, the box containing the key combination might get truncated.

- When an encoder is switched to Unicast mode and restarted, it still can receive the USB stream coming from a decoder in Multicast mode and having the same Video Stream ID.
- The Programmers' LW3 Terminal window might get rendered incorrectly at certain resolutions.
- When dragged at certain pixel positions it is impossible to move an item from the tile representing a video wall element on the Video Wall Setup page.
- Switching source or destination through the Device list pane on the Main Settings page of the encoder or decoder might take more time compared to switching directly by modifying the ID in the Video stream ID box.

Known issue:

- When defining a shortcut key combination for switching to previous or next stream or for a stream shortcut, and the shortcut key combination has more modifier keys, the box containing the key combination might get truncated.
- When an encoder is switched to Unicast mode and restarted, it still can receive the USB stream coming from a decoder in Multicast mode and having the same Video Stream ID.
- The Programmers' LW3 Terminal window might get rendered incorrectly at certain resolutions.
- When dragged at certain pixel positions it is impossible to move an item from the tile representing a video wall element on the Video Wall Setup page.
- Switching source or destination through the Device list pane on the Main Settings page of the encoder or decoder might take more time compared to switching directly by modifying the ID in the Video stream ID box.

v1.0.0b11

Release date: 2017-12-14

10.10. Application Note (LW-AN-001)

Gigabit Network Switch Requirements For VINX Devices

Network Properties

Network-based AV products use different network protocols for different operations. The network protocol can be UDP/IP and TCP/IP, the transmission mode can be Broadcast, Unicast, and Multicast.

These network protocols should be familiar to any network engineer. Because our network-based AV solutions bridge the gap between the audio-visual (AV) and information technology (IT) worlds, Lightware suggests involvement of both AV and IT departments in any installation.

Lightware products are designed to be plug-and-play. The figures in the next section illustrate the basic installation of one Decoder and one Encoder. A video source provides the digital video content to the Encoder which converts to Ethernet packets and sends to the attached Decoder. The Decoder reconstitutes the video with synchronized audio for presentation to the attached display.

Point-to-point vs Network Connection

VINX Encoders and Decoders have two typical applications:

- Point-to-point connection
- Point-to-multi point connection

Point-to-point Connection (Unicast mode)

Unicast transmission mode uses a one-to-one association between the source and the destination: each destination address uniquely identifies a single Decoder endpoint.



Point-to-Multi Point Connection (Multicast mode)

Multicast transmission mode uses a one-to-one or one-to-many association; multicast datagrams are forwarded simultaneously in a single transmission to many recipients through L2 switched network. There can be multiple encoders in a L2 subnet. The decoders have to be in the same subnet.



Unicast Routing

The packet forwarding requirement of the VINX devices for point-to-point connection is the unicast switching. Please note the unicast mode is not the default setting of the Encoder and Decoder, users have to set it in the devices.

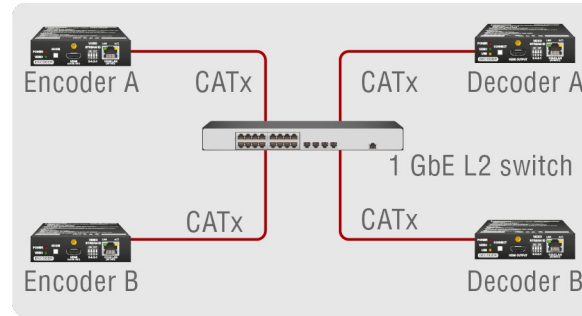

Hardware Requirement:

- 1 GbE Layer 2 (L2) switch

ATTENTION! VINX devices send certain system commands over multicast packages. If the multicast packet forwarding is disabled on the network, the signal transmission can fail.

Managed Switch for Multicast Routing

In TCP/IP terminology Layer 2 is the data link layer that is responsible for splitting the information coming from higher layers in the TCP/IP stack into Ethernet frames. An Ethernet frame includes, among others, labeling information with source and destination physical addresses (called source and destination MAC address). These physical addresses uniquely identify the source and destination physical devices (e.g. a VINX Encoder and a VINX Decoder). Ethernet frames provide error resilience by incorporating a redundancy check field through which transmission errors can easily be detected. The device that uses only the physical address information found in the Ethernet frame to forward a packet from one of its input ports to one or more of its output ports is an unmanaged switch.

A managed switch, on the other hand, can handle the traffic and forward input packets to output packets by utilizing information from higher layers. This gives the managed switch more flexibility and also allows for more sophisticated functions like multicast forwarding. Since even a simple VINX network, where one VINX Encoder supplies more VINX Decoders, relies on multicasting, a multicast capable switch (i.e. a managed one) is mandatory. If non-managed switches transmit the multicast packages, the multicast traffic is usually broadcasted over all interfaces.

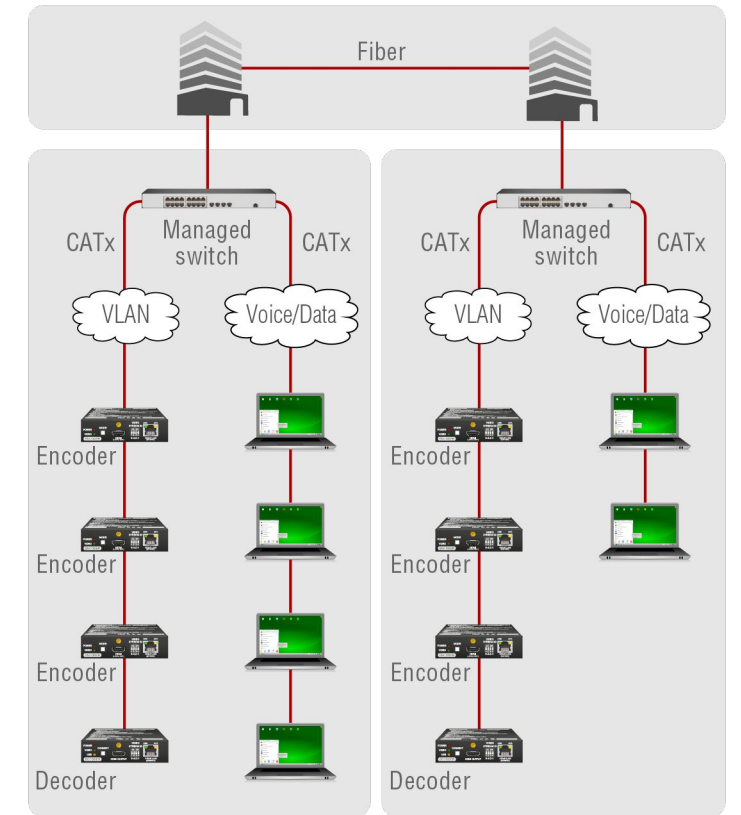

Hardware Requirement:

- 1 GbE Layer 3 (L3) switch or managed L2 switch

Why is it important?

By default, Lightware Video-over-IP Encoders and Decoders use multicast packet forwarding. The switches in the network shall offer the following capabilities:

- IGMPv2
- IGMP snooping
- IGMP fast leave
- IGMP Querier
- Multicast filtering
- 9k MTU - Jumbo/Giant frames

Switch Setup for Dante® Audio Signal Transmission

You can configure the QoS settings to ensure good system performance in a busy network. QoS (Quality of Service) refers to technology for prioritizing the transfer of specific data. By configuring the QoS settings recommended by Dante® on a network switch, you can prioritize the transfer of Dante® clock synchronization data and audio data over background data traffic. This will ensure good system performance when you need to transfer non-Dante® data over the same network. QoS is required when using Dante in networks that have 100Mbps devices and is optional in networks with Gigabit devices. We recommend that QoS be enabled in all Dante® networks in order to ensure proper operation under all possible conditions.

The table below shows how Dante uses various Diffserv Code Points (DSCP) packet priority values: *

Priority	Usage	DSCP Label	Hex	Decimal	Binary
High	Time critical PTP events	CS7	0x38	56	111000
Medium	Audio, PTP	EF	0x2E	46	101110
Low	(reserved)	CS1	0x08	8	001000
None	Other traffic	BestEffort	0x00	0	000000

Green Ethernet in the Network

EEE (Energy Efficient Ethernet) is a technology that reduces switch power consumption during periods of low network traffic. It is also sometimes known as Green Ethernet and IEEE802.3az.

Although power management should be negotiated automatically in switches that support EEE, it is a relatively new technology, and some switches do not perform the negotiation properly. This may cause EEE to be enabled in Dante networks when it is not appropriate, resulting in poor synchronisation performance and occasional dropouts.

Managed Switch Properties in Details

IGMPv2

IGMPv2 is version 2 of the Internet Group Management Protocol. This protocol is used by end-point devices to signal their interest in receiving

* source: <https://www.audinate.com/faq-catagories/switches>

a specific multicast content via subscribing to the multicast group corresponding to the content. Using IGMPv2 packets, the end-point devices can send a leave message to indicate that they are no longer interested in receiving the stream of the multicast group. Moreover, a multicast capable router can periodically poll the end-point devices on its interfaces which multicast streams they are interested to receive. The answer to such a query is called a membership report. IGMPv2 must be supported by the managed switch.

IGMP Snooping

IGMP snooping is a feature which allows the switch to monitor IGMP traffic when enabled. The information collected from the IGMP packets is used by the managed switch to determine which interfaces the multicast traffic should be forwarded to. In other words, IGMP snooping is used to conserve bandwidth by allowing the switch to forward multicast traffic to those interfaces where it is really required.

IGMP Fast Leave

IGMP fast leave (or immediate leave), when configured, reduces the amount of time it takes for the managed switch to stop sending multicast traffic (corresponding to a multicast group defined by a multicast address) to an interface, where all end-point devices that used to be interested in a stream have sent a IGMP leave message. Without fast leave being enabled the managed switch would first send out a query message and then would stop forwarding when no end-points answered within a pre-specified time interval. If fast leave is enabled, the switch stops forwarding the traffic without sending a query message.

IGMP Querier

In order for IGMP snooping to work properly, IGMP messages must traverse in the subnet between managed switches. However, if there is no multicast capable router present periodically sending out query messages and receiving answers to those queries, IGMP messages are usually not forwarded upstream from one switch to another. By enabling the IGMP querier feature in a managed switch, the managed switch will act like a router and periodically query the devices in the subnet (even other managed switches) to send their membership reports. From those report all the listening switches with IGMP snooping enabled will be able to determine where multicast traffic should be sent to.

Multicast Filtering

Some control information from VINX devices is transmitted via multicast packets. However, these packets are not registered during certain startup intervals or not registered at all. In order for all VINX

devices in the subnet to receive such control information, multicast filtering must be set up, so that unregistered groups are forwarded to all interfaces on the managed switch.

Jumbo/Giant Frames

Ethernet frames consist of a header and a payload. Since the header has a fixed length (20 or 26 bytes) the bigger the payload, the higher the useful bandwidth is. Similarly, the higher the useful bandwidth, the better the picture quality of the encoded video stream will be. To maximize picture quality, the Ethernet frame size (and consequently, the payload) should be as high as possible. In a normal Ethernet frame, the payload can be at most 1500 bytes. An Ethernet jumbo frame, however, can carry up to 9000 bytes of payload. Since the goal of the transmission is to provide the best possible picture quality in all circumstances, the VINX Encoder device produces Ethernet jumbo frames. Thus, the handling of jumbo frames has to be enabled in the managed switches.

10.11. Hashtag Keyword List

This user's manual contains keywords with hashtag (#) to help you to find the relevant information as quick as possible.

The format of the keywords is the following:

#<keyword>

The usage of the keywords: use the **Search** function (Ctrl+F / Cmd+F) of your PDF reader application, type the # (hashtag) character and the wished keyword.

The **#new** special keyword indicates a new feature/function that has just appeared in the latest firmware or software version.

Example

#dhcp

This keyword is placed at the DHCP (dynamic IP address) setting in the front panel operation, the Lightware Device Controller (LDC) and the LW3 programmer's reference section.

The following list contains all hashtag keywords placed in the document with a short description belonging to them. The list is in **alphabetical order** by the hashtag keywords.

Hashtag keyword ↓↑	Description
<i>#advancedview</i>	Advanced view window
<i>#analogaudio</i>	Analog audio related settings
<i>#audio</i>	Audio related settings
<i>#bandwidth</i>	Video stream bandwidth settings
<i>#button</i>	Description of the front panel buttons
<i>#compression</i>	Video compression settings
<i>#crosspoint</i>	Crosspoint switch setting
<i>#dante</i>	Dante® audio related settings
<i>#devicelabel</i>	Device label
<i>#dhcp</i>	Dynamic IP address (DHCP) setting
<i>#dipswitch</i>	Description of the front panel DIP switches
<i>#edid</i>	EDID related settings
<i>#factory</i>	Factory default settings
<i>#firmwareversion</i>	Firmware version query

Hashtag keyword ↓↑	Description
<i>#flip</i>	Picture rotation/flip setting
<i>#framedetector</i>	Frame detector in LDC/built-in web
<i>#hdcpc</i>	HDCP-encryption related setting
<i>#inputselection</i>	Video input selection for VINX-210AP-HDMI-ENC model
<i>#ipaddress</i>	IP address related settings
<i>#kvm</i>	USB KVM related settings
<i>#label</i>	Device label
<i>#led</i>	Description of the front panel LEDs
<i>#multicast</i>	Multicast mode setting
<i>#mute</i>	Mute/unmute (for analog audio) setting
<i>#network</i>	Network (IP address) related settings
<i>#new</i>	New feature/function of the product
<i>#osd</i>	OSD settings
<i>#qualitymode</i>	Video quality mode setting
<i>#reboot</i>	Restarting the device
<i>#reset</i>	Restarting the device
<i>#resolution</i>	Resolution of the video signal query
<i>#restart</i>	Restarting the device
<i>#rotation</i>	Picture rotation/flip setting
<i>#rs232</i>	RS-232 related settings
<i>#rs-232</i>	RS-232 related settings
<i>#scaler</i>	Scaler related settings
<i>#serial</i>	RS-232 related settings
<i>#signaltype</i>	Signal type (HDMI/DVI) setting
<i>#source</i>	Video source selection
<i>#status</i>	Status query
<i>#streamid</i>	Video Stream ID settings
<i>#switch</i>	Crosspoint switch setting
<i>#terminal</i>	Advanced view window

Hashtag keyword ↓↑	Description
<i>#unicast</i>	Unicast mode setting
<i>#unmute</i>	Mute/unmute (for analog audio) setting
<i>#usbkvm</i>	USB KVM related settings
<i>#videoquality</i>	Video quality mode setting
<i>#videostreamid</i>	Video Stream ID settings
<i>#videowall</i>	Videowall related settings
<i>#volume</i>	Volume (for analog audio) setting

10.12. Further Information

Limited Warranty Statement

1. Lightware Visual Engineering LLC (Lightware) warrants to all trade and end user customers that any Lightware product purchased will be free from manufacturing defects in both material and workmanship for three (3) years from purchase unless stated otherwise below. The warranty period will begin on the latest possible date where proof of purchase/delivery can be provided by the customer. In the event that no proof can be provided (empty 'Date of purchase' field or a copy of invoice), the warranty period will begin from the point of delivery from Lightware.

1.1. 25G and MODEX product series will be subject to a seven (7) year warranty period under the same terms as outlined in this document.

1.2. If during the first three (3) months of purchase, the customer is unhappy with any aspect of a Lightware product, Lightware will accept a return for full credit.

1.3. Any product that fails in the first six (6) months of the warranty period will automatically be eligible for replacement and advanced replacement where available. Any replacements provided will be warranted for the remainder of the original unit's warranty period.

1.4. Product failures from six (6) months to the end of the warranty period will either be repaired or replaced at the discretion of Lightware. If Lightware chooses to replace the product then the replacement will be warranted for the remainder of the original unit's warranty period.

2. The above-stated warranty and procedures will not apply to any product that has been:

2.1. Modified, repaired or altered by anyone other than a certified Lightware engineer unless expressly agreed beforehand.

2.2. Used in any application other than that for which it was intended.

2.3. Subjected to any mechanical or electrical abuse or accidental damage.

2.4. Any costs incurred for repair/replacement of goods that fall into the above categories (2.1., 2.2., 2.3.) will be borne by the customer at a pre-agreed figure.

3. All products to be returned to Lightware require a return material authorization number (RMA) prior to shipment and this number must be clearly marked on the box. If an RMA number is not obtained or is not clearly marked on the box, Lightware will refuse the shipment.

3.1. The customer will be responsible for in-bound and Lightware will be responsible for out-bound shipping costs.

3.2. Newly repaired or replaced products will be warranted to the end of the originally purchased products warranty period.

Document Revision History

Rev.	Release date	Changes	Editor
1.0	21-12-2017	Initial release.	Laszlo Zsedenyi
:			
1.4	24-10-2018	Addition to LW3 commands; minor changes due to new firmware; signal diagrams refined.	Laszlo Zsedenyi
1.5	11-01-2019	Crosspoint view added to SW control; Crosspoint switching examples added; Mounting into Rackmount-cage added; FW upgrade section upgraded; Minor graphical updates	Laszlo Zsedenyi
1.6	24-07-2019	All chapters updated with the new devices (AP-series); model comparison table added; RS-232 technology description added; release notes of firmware packages added	Laszlo Zsedenyi
1.7	19-09-2019	Front/rear photos corrected; Descriptions of front panel buttons corrected; Minor typo corrections	Laszlo Zsedenyi
1.8	22-01-2020	'DNT' model and corresponding descriptions added; Software control chapter upgraded; LW3 network commands upgraded; #keywords added.	Laszlo Zsedenyi
1.9	20-03-2020	SW control chapter completed; 'DNT' port diagram replaced; Mic input spec corrected; frame delay corrected; USB limitation clarified	Laszlo Zsedenyi
2.0	13-08-2020	Document re-structured; Graphical and minor updates	Laszlo Zsedenyi

Contact Us

sales@lightware.com

+36 1 255 3800

support@lightware.com

+36 1 255 3810

Lightware Visual Engineering LLC.
Peterdy 15, Budapest H-1071, Hungary

www.lightware.com

©2020 Lightware Visual Engineering. All rights reserved. All trademarks mentioned are the property of their respective owners. Specifications subject to change without notice.